

Fred C.
Gloeckner
&
Company,
Incorporated

**2018-2019
GREENHOUSE
GROWER
SUPPLIES
CATALOG**

*Loop's Nursery of Jacksonville, FL...
Loyal Customer and Friend Since 1949!*

800-345-3787

www.fredgloeckner.com

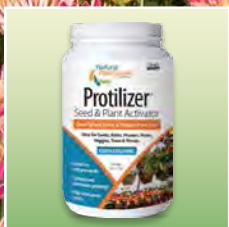



Attko

Greenhouse, Inc.

- Venlo Style Glass Houses
- Wide Span Houses
- Open Roof Houses
- Ventilation Systems
- Cooling Installations
- Hot Water Heating Systems
- Greenhouse Renovations
- Energy Curtain Systems



Your Supplier of Quality Greenhouse Structures and Installations
www.Attko.com

Email: Info@attko.com Phone: 770-222-0410 Fax: 770-222-0409

From the Desk of Joe Simone

Dear Commercial Grower,

Welcome to the hot-off-the-presses print version of the 2018-2019 Gloeckner Greenhouse Grower Supplies Catalog. We're confident you'll be able to find in this formidable resource, most of the products you'll need to complement your hands-on plant care.

The new 2018-2019 catalog features an abundance of new products, many unique to Gloeckner. This includes an extensive presentation of Poppelmann Pots and Containers (pages 6-11), as well as many new Dramm irrigation related products. Moreover, you'll find 1,000s of everyday used staples and a robust selection of capital equipment. Of particular note is the Philips line of LED lighting on pages 70-72; Gloeckner is one of a few select distributors nationwide with the expertise and authorization to promote this transformative line.



A Great Catalog and Much More from Gloeckner!

- **Storefront Grower Supplies Online Ordering:** Up and running is Gloeckner's new online ordering/operations portal for greenhouse grower supplies (fredgloeckner.com). With 1,000s of items featured, safe and easy-to-use fredgloeckner.com is ready to accommodate your ordering needs. Valuable operational tools populate the site including purchasing history, shipping status, and more.
- **Outside Sales:** Gloeckner has full national and select international coverage to provide expert assistance and solutions as needed (see pages 2 & 3). This includes Ricardo Campos who is solely dedicated to developing the ideal recipe of Philips LED lighting for your business. Moreover, many of the Gloeckner reps are ex-growers who can furnish another set of eyes for your growing challenges.
- **Single Source for Hard Goods and Plants, Seeds, and Bulbs:** Single sourcing with one qualified source like Gloeckner delivers proven benefits. Gloeckner's lines of young plants/plugs, seeds, and bulbs continue to expand and flourish, and if we're not your preferred source for these items, please reconsider and explore the logistical benefits of one source of supply.

We'd like to thank our many loyal customers and friends for their continued support, particularly David and Leighton Loop of Loop's Nursery, Jacksonville, FL, featured on our cover. To those of you who have not benefitted from our product expertise and hands-on service, we ask that you give us the opportunity to prove ourselves to you as we've done with many of your professional peers. You will not be disappointed.

Joseph A. Simone

President, CEO

TABLE OF CONTENTS

General Information.....	1-3
New & Featured	4-5
Containers.....	6-37
Media	38-43
Fertilizers	44-49
Chemicals	50-59
Grower's Equipment	60-73
Irrigation Equipment & Supplies	74-83
Greenhouse Structures.....	84-97
Greenhouse Coverings/Accessories	98-105
Greenhouse Equipment	106-117
Crop Protection	118-122
General Supplies.....	123-143
Retail	144-145
Technical Support.....	146-147
Terms & Conditions/Index	148-152



**Special Thanks to
Loop's Nursery,
Jacksonville, FL**
See page 30 for more info.

ORDERING INFORMATION

By Phone*: 800-345-3787/914-698-2300

*Request assistance and order direct with your local field representative – see pages 2-3. **Hablamos Español.**

By E-Mail: info@fredgloeckner.com

Online: www.fredgloeckner.com

By Mail: Fred C. Gloeckner & Co., Inc.
550 Mamaroneck Ave.
Harrison, NY 10528-1609

By Fax: Supply Division: 914-698-0848
International Division: 914-698-2840

Purchase Orders: Purchase orders gladly accepted from accredited universities, government entities and non-profit organizations.

International Orders: It's easy to conduct international business with Gloeckner. We have all of the support personnel and systems in place to assure 100% customer satisfaction, no matter the destination of the order. A pro forma invoice will be provided to you complete with delivery times, CIF or C & F destination pricing and shipping charges.

Phone: 914-698-2300 ext.131 or 133

E-Mail: malvarez@fredgloeckner.com

Fax: 914-698-2840

Mail: See left column

PAYMENT INFORMATION

Credit Cards:

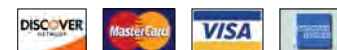

Check or Money Order: Make checks or money orders payable in US dollars, drawn on a US bank to: Fred C. Gloeckner & Co., Inc.
550 Mamaroneck Ave.
Harrison, NY 10528-1609

Wire Transfers: All wire transfers accepted in US dollars.
Please reference invoice number.

Bank: Wells Fargo Bank, N.A. **Account #:** 4122247935
ABA #: 121000248 **SWIFT Reference:** W F B I U S 6 S

Open Account: Net 30 days. Credit applications are available at www.fredgloeckner.com or by calling 800-345-3787.

NORTHEAST/SOUTHEAST

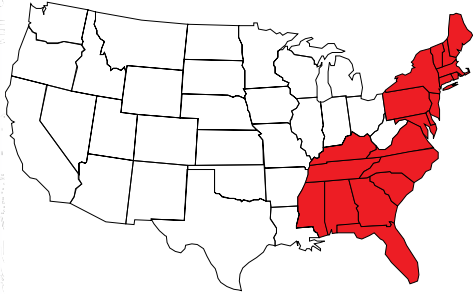

Tom Caan
 Baltimore, MD 21231
 Cell: 920-912-3904
 Fax: 443-449-6645
 tcaan@fredgloeckner.com
Territory: Eastern PA, Southern NJ, DE, MD

Jeffrey den Breejen
 Fredon, NJ 07860
 973-940-2700/Cell: 973-534-1910
 jeff@ednieflowerbulb.com
Territory: Southeast, Mid Atlantic

Bob Humm
 Akron, OH 44312
 330-699-1345/Cell: 330-620-5306
 rhumm@fredgloeckner.com
Territory: Western NY, Western PA

Jeff Nameth
 Arden, NC 28704-2608
 Cell: 828-215-6322
 jeffnameth@bellsouth.net
Territory: VA, NC, FL, SC

Gene Orsini
 Dumont, NJ 07628
 201-385-0173
 Fax: 201-385-1272
 geneorsini@optonline.net
**Territory: Northern & Central NJ,
 Southern NY, Western MA**

Tom Seibert
 Marietta, GA 30066
 Cell: 404-416-6713
 tseibert@fredgloeckner.com
**Territory: GA, AL, KY, TN, MS,
 Northern Panhandle FL**

David J. Toohey
 Foster, RI 02825
 Cell: 401-226-8876
 Home/Fax: 401-397-2531
 dtoohey@fredgloeckner.com
Territory: NH, VT, MA, RI, ME

Jan Van Oosten
 Phillipsburg, NJ 08865
 Cell: 973-919-4051
 jan@ednieflowerbulb.com
Territory: New England, Mid Atlantic

Walter Bissex
 South Huntington, NY 11746
 Cell: 516-982-5925
 Fax: 631-385-7567
 wbissex@fredgloeckner.com
**Territory: CT, NY (Westchester County,
 Metropolitan area/NYC, Long Island)**

Cut Flower Specialist
Dave Dowling
 Fredon, NJ 07860
 973-940-2700
 dave@ednieflowerbulb.com
Territory: USA, Canada

WEST COAST

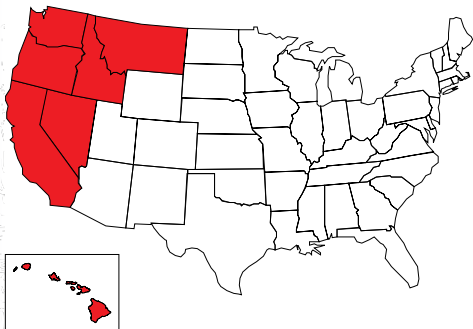

Michael Cardosa
 Carlsbad, CA 92011
 760-931-8510/Cell: 760-688-6881
 Fax: 760-438-1601
 mcardosa@fredgloeckner.com
Territory: CA, HI

E. Dick den Breejen
 Fredon, NJ 07860
 Cell: 973-903-7253
 MisterD@ednieflowerbulb.com
Territory: Midwest, West Coast, Canada

Tom Jobb
 Bothell, WA 98012
 Cell: 206-612-3350
 Fax: 425-967-5829
 tjobb@fredgloeckner.com
Territory: WA, OR, ID, MT, Alberta BC

Tim Quirk
 Grover Beach, CA 93433
 Cell: 805-709-6161
 Fax: 805-481-0773
 tquirk@fredgloeckner.com
Territory: CA, HI

SOUTHWEST

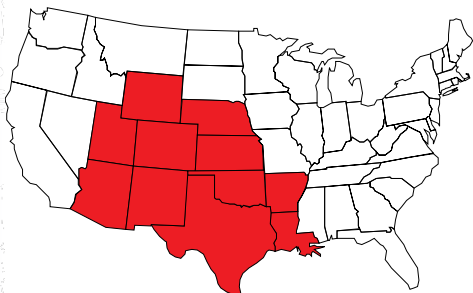

Dan Busch
 Broomfield, CO 80020
 Cell: 303-725-1779
 Fax: 303-583-8353
 dbusch@fredgloeckner.com
**Territory: CO, WY, AZ, KS, NE, UT,
 Northern NM**

Clay Hendon
 Compton, AR 72624
 979-561-6167
 chendon@fredgloeckner.com
Territory: OK, AR, LA, TX

**Manager LED Solutions,
 United States**

Ricardo Campos
 Encinitas, CA 92024
 760-707-7065
 rcampos@fredgloeckner.com

Richard J. Boesen

Des Moines, IA 50322
 Cell: 515-306-9975
 Fax: 515-277-1326
 rboesen@fredgloeckner.com
Territory: IA, KS, MO, IL

E. Dick den Breejen

Fredon, NJ 07860
 Cell: 973-903-7253
 MisterD@ednieflowerbulb.com
Territory: Midwest, West Coast, Canada

Shayne Johnson

Lakeville, MN 55044
 Cell: 952-836-6180
 Fax: 952-435-9048
 sjohnson@fredgloeckner.com
Territory: MN, IA, ND, SD, Western WI

Brock T. Lehman

Canton, OH 44721
 Cell: 330-687-4387
 Fax: 330-838-2253
 brocktlehman@gmail.com
Territory: OH, WV, KY

Matthew Miller

Neillsville, WI 54456
 715-819-1018/Cell: 608-630-0345
 Fax: 800-731-7886
 mmiller@fredgloeckner.com
Territory: WI, Northern IL, Michigan UP

Michael J. Porto

Tipp City, OH 45371
 Cell: 937-479-2089
 Fax: 937-506-8407
 mporto@fredgloeckner.com
Territory: MI, IN, Northwest OH

MIDWEST

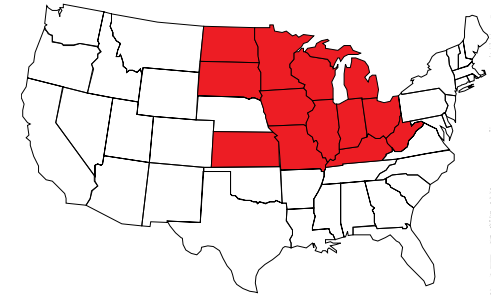

Canada

Monica Alvarez

Harrison, NY 10528
 914-607-5433
 malvarez@fredgloeckner.com

E. Dick den Breejen

Fredon, NJ 07860
 Cell: 973-903-7253
 MisterD@ednieflowerbulb.com

Tom Jobb

Bothell, WA 98012
 Cell: 206-612-3350
 Fax: 425-967-5829
 tjobb@fredgloeckner.com

Manager LED Solutions

Ricardo Campos

Encinitas, CA 92024
 760-707-7065
 rcampos@fredgloeckner.com

**INTERNATIONAL DIVISION
 (Hablamos Español)**



Mexico, Central & South America

Gloeckner Colombia

Contact: Lix Villarraga
 Cell: +314-4507682
 lvillarraga@fredgloeckner.com

Contact: Gustavo Ochoa
 Cell: +3115222671
 gochoa@fredgloeckner.com

Gloeckner Ecuador

Contact: Carlos Martinez
 Cell: +999301980
 cmartinez@fredgloeckner.com

Bersal Group – Uruguay

Contact: Martin Salaberry
 +598-26235078
 msalaberry@bersalgroup.com

Germán Tencio Masís – Costa Rica

+506 888 43469
 German.tencio10@gmail.com

FloraPlant SV de CV – Mexico

Contact: Gilberto Gomez Peltier
 +7773620152
 Gilberto@floraplant.com

Incaforest E.I.R.L. – Peru

Contact: Maria Quevedo Guillen
 Tel: +51-12712004
 incaparq@hotmail.com

**Floreska Villa Guerrero
 (Flor de Corte) – Mexico**

Contact: Alberto Puebla
 714 1462166
 floreskavilla@hotmail.com



For the rest of your INTERNATIONAL inquiries, please contact:

Toll Free in US: 800-345-3787
 Outside the US: 914-698-2300

Monica Alvarez Ext. 133
 malvarez@fredgloeckner.com

Amparo Galarza Ext. 131
 agalarza@fredgloeckner.com

NEW & FEATURED PRODUCTS



Fertilizers

First in Fertilizers Since 1922!

Pages 44-45, 144



Pages 25-30



Containers

Innovations in Thermoforming!



Pages 12-24



The HC Companies™
Leader in Horticultural Containers

Containers Galore!



Inside Front Cover, pages 92-93



Attko *Venlo and Open Roof Style Specialists!*

Greenhouse, Inc.



Page 111



Automated Temperature Controllers

Take Control!



Page 104



Resolite®

Macrolux® Strong!

A DIVISION OF STABILIT AMERICA



Page 61



Injectors

60 Years of Innovation!

www.heanderson.com



Pages 109, 119, 130



Grower Supplies

Performance Plus!

Products For The Grower



Tyne Grower Supplies

Back to Basics!

Pages 122, 128, 132-133



LED Lighting
Transformative!

Pages 70-72



Jiffy **Jiffy-70**
Container and Media in One!

Page 38



Big Bag Beds
Big & Bad!

Page 145



Pages 123,
Inside Back Cover



Shading Systems
Beat the Heat!



MasterTag **Plant Tags**
The Industry Standard!

Pages 126-127, 152



Plant Food
100% Organic!

Page 51



Pages 96-97



Curtains & Accessories
Easy On and Off!



Decowraps *Brilliant!*

Page 135



Pages 6-11



Pots & Containers
German Engineered!



THERMOFORMED ROUND POTS & CONTAINERS

New Listings!

- *Reduced cultivation time* – rapid growth and healthy plants due to ideal water and drainage.
- *Easy de-nesting* – facet rim and high degree of lateral stability ensure easy de-nesting from the stack in the pot magazine
- *Easily stacked* – posts are stacked using the patented facet rim for error-free stacking
- *Better handling* – U-rim for modern spacing-machine applications; deburred raw edge is user-friendly and reduces the risk of injury
- *Strong hold* – Groove profile on all sides provides stability and special shape ensures a strong hold for adhesive labels
- *Recycled materials; reduced weight*, low materials usage



VCC Standard 5°



VCD 5° Azalea

VCC Standard 5°

Item #	Mfr #	Width	Height	Color	Case Pk	Price (\$)
51759	VCC 10 VOL-0375X	3 ¾"	3 ½"	BK	2,970	162.20
51760	VCC 10 VOL-0375X	3 ¾"	3 ½"	TC	2,970	162.20
50139	VCC 10 F US-0400X	4"	3 ⅝"	BK	2,668	144.11
50133	VCC 10 US-0400X	4"	3 ½"	BK	2,668	144.11
50135	VCC 10 US-0400X	4"	3 ½"	TC	2,668	151.29
50147	VCC 10.5 US-0415X	4 ⅛"	3 ½"	BK	2,125	132.43
50151	VCC 11 US-0450X	4 ½"	3 ¾"	BK	1,896	130.88
50153	VCC 11 US-0450X	4 ½"	3 ¾"	TC	1,896	137.40
50167	VCC 12 US-0475X	4 ¾"	4 ⅛"	BK	1,420	113.39
50169	VCC 12 US-0475X	4 ¾"	4 ⅛"	TC	1,420	119.07
50173	VCC 12 F US-0475X	4 ¾"	4 ¾"	BK	1,440	141.08
50175	VCC 12 F US-0475X	4 ¾"	4 ¾"	TC	1,440	148.11
50181	VCC 13 F US-0500X	5"	4 ½"	BK	1,024	104.37
50183	VCC 13 F US-0500X	5"	4 ½"	TC	1,024	109.60
50195	VCC 15 US-0600X	6"	5"	BK	744	105.95
50197	VCC 15 US-0600X	6"	5"	TC	744	111.23
50201	VCC 15 F US-0600X	6"	5 ¾"	BK	708	105.91
50203	VCC 15 F US-0600X	6"	5 ¾"	TC	708	111.20
50207	VCC 16 F US-0625X	6 ¼"	6 ⅞"	BK	396	66.13
50209	VCC 16 F US-0625X	6 ¼"	6 ⅞"	TC	396	69.44
50215	VCC 16.5-0650X	6 ½"	6 ⅞"	BK	450	75.16
50217	VCC 16.5-0650X	6 ½"	6 ⅞"	TC	450	78.91
51761*	VCC 16.5 K-0650X	6 ½"	6 ⅞"	BK	450	71.81
51763*	VCC 16.5 K-0650X	6 ½"	6 ⅞"	TC	450	75.40
50223	VCC 19-0750X	7 ½"	7 ⅞"	BK	384	63.53
50225	VCC 19-0750X	7 ½"	7 ⅞"	TC	384	66.72
51765	VCC 21-0825X	8 ¼"	7 ¼"	BK	258	114.43
51766	VCC 21-0825X	8 ¼"	7 ¼"	TC	258	120.15
51767	VCC 22-0865X	8 ⅔"	7 ½"	BK	222	107.25
51768	VCC 22-0865X	8 ⅔"	7 ½"	TC	222	112.61

*Tag lock slots in the rim.

VCD 5° Azalea

Item #	Mfr #	Width	Height	Color	Case Pk	Price (\$)
50091	VCD 10 US-0400X	4"	3"	BK	2,726	135.51
50093	VCD 10 US-0400X	4"	3"	TC	2,726	142.29
50111	VCD 16.5-0650X	6 ½"	5"	BK	530	82.05
50113	VCD 16.5-0650X	6 ½"	5"	TC	530	86.16
50117	VCD 19-0750X	7 ½"	5 ⅞"	BK	400	83.13
50119	VCD 19-0750X	7 ½"	5 ⅞"	TC	400	87.29
51777	VCD 21-0825X	8 ¼"	6 ¼"	BK	258	106.75
51778	VCD 21-0825X	8 ¼"	6 ¼"	TC	258	112.08
51779	VCD 21 D-0825X	8 ¼"	5"	BK	288	85.49
51780	VCD 21 D-0825X	8 ¼"	5"	TC	288	89.77
51781	VCD 22-0865X	8 ⅔"	7"	BK	234	130.00
51782	VCD 22-0865X	8 ⅔"	7"	TC	234	108.15

VTD 8° Azalea

Item #	Mfr #	Width	Height	Color	Case Pack	Price (\$)
50045	VTD 10 US-0400X	4"	2 7/8"	BK	2,726	132.77
50047	VTD 10 US-0400X	4"	2 7/8"	TC	2,726	139.39
50057	VTD 11 US-0450X	4 1/2"	3 1/8"	BK	1,944	125.09
50059	VTD 11 US-0450X	4 1/2"	3 1/8"	TC	1,944	131.33
50071	VTD 12 US-0475X	4 3/4"	3 3/8"	BK	1,460	105.59
50073	VTD 12 US-0475X	4 3/4"	3 3/8"	TC	1,460	110.87
50077	VTD 13 US-0500X	5"	3 3/4"	BK	1,088	103.40
50079	VTD 13 US-0500X	5"	3 3/4"	TC	1,088	108.59
50083	VTD 15 US-0600X	6"	4 1/4"	BK	780	86.11
50085	VTD 15 US-0600X	6"	4 1/4"	TC	780	90.41



VTD 8° Azalea

MXC 6° Azalea

Item #	Mfr #	Width	Height	Color	Case Pk	Price (\$)
51794	MXC 5.5-0215X	2 1/8"	2"	BK	6,084	287.57
51795	MXC 5.5-0215X	2 1/8"	2"	TC	6,084	302.01
51796	MXC 9-0350X	3 1/2"	2 2/3"	BK	1,664	106.65
51797	MXC 9-0350X	3 1/2"	2 2/3"	TC	1,664	111.97
51798	MXC 10-0400X	4"	3"	BK	1,702	130.87
51799	MXC 10-0400X	4"	3"	TC	1,702	137.41
51800	MXC 10.5-0415X	4 1/8"	3 1/8"	BK	1,430	110.99
51801	MXC 10.5-0415X	4 1/8"	3 1/8"	TC	1,430	116.53
51802	MXC 11-0450X	4 1/2"	3 1/4"	BK	1,200	165.49
51803	MXC 11-0450X	4 1/2"	3 1/4"	TC	1,200	173.77
51804	MXC 12-0475X	4 3/4"	3 2/3"	BK	756	76.73
51805	MXC 12-0475X	4 3/4"	3 2/3"	TC	756	80.57
51806	MXC 13-0500X	5"	3 7/8"	BK	738	92.33
51807	MXC 13-0500X	5"	3 7/8"	TC	738	96.96
51808	MXC 14-0550X	5 1/2"	4 1/2"	BK	640	89.41
51809	MXC 14-0550X	5 1/2"	4 1/2"	TC	640	93.88
50265	MXC 15 Z-0600X	6"	4 1/4"	BK	405	59.93
50267	MXC 15 Z-0600X	6"	4 1/4"	TC	405	62.93
50271	MXC 15 W-0600X	6"	5 2/3"	BK	405	59.93
50273	MXC 15 W-0600X	6"	5 2/3"	TC	405	62.93



MXC 6° Azalea

MCI 5° Azalea

Item #	Mfr #	Width	Height	Color	Case Pk	Price (\$)
51810	MCI 18-700X	7"	5 1/2"	BK	216	67.25
51811	MCI 18-600X	7"	5 1/2"	TC	216	70.63
51812	MCI 20-0800X	8"	6 1/8"	BK	75	33.73
51813	MCI 20-0800X	8"	6 1/8"	TC	75	35.41
51814	MCI 21-0825X	8 1/4"	6 1/2"	BK	70	32.24
51815	MCI 21-0825X	8 1/4"	6 1/2"	TC	70	33.85
51816	MCI 23-0900X	9"	7 1/8"	BK	65	35.72
51817	MCI 23-0900X	9"	7 1/8"	TC	65	37.51
51818	MCI 26-1025X	10 1/4"	8 1/4"	BK	55	47.31
51819	MCI 26-1025X	10 1/4"	8 1/4"	TC	55	49.67
51820	MCI 29-1150X	11 3/8"	8 5/8"	BK	55	61.96
51821	MCI 29-1150X	11 3/8"	8 5/8"	TC	55	65.05



MCI 5° Azalea

Green and white basket colors are available upon request.

See page 8 for corresponding trays.



UT 9-0350/15 STD



UT 10-0400/10



UT 10-0400/15



UT 11-0450/10
UT 11 T-0450/10



UT 11-0450/15



UT 12-0475/8



UT 12-0475/12 F-US



UT 13-0500/8



UT 14-0550/8 M



UT 15-0600/6



UT 16-0625/6 F-US



UT 16.5-0650/6



UT 16.5 K-0650/6 STD



UT 17-0675/6 STD

UT TRANSPORT AND CULTIVATION TRAYS *New Listings!*

- *Reliable drainage* – central hole in the bottom of the side slots ensure reliable drainage during cultivation
- *Even de-nesting* – evenly formed contours and reliable stacking TRKU® trays are easy and fast to separate
- *Stability* – well designed for increased stability
- *Recycled materials; reduced weight*, low materials usage

Item #	Mfr #	Length	Width	Height	Pots*	Case Pk	Price (\$)
51785	UT 9-0350/15 STD	20 ½"	12 ¾"	3 ½"	VCC 9 US	66	78.24
50362	UT 10-0400/10 AZ	21"	8 ½"	3 ½"	0.4 AZ	50	37.57
50364	UT 10-0400/10F-US	21"	8 ½"	3 ¾"	VCC 10 F US	48	36.07
50366	UT 10-0400/10 STD	21"	8 ½"	3 ¾"	0.4 STD	50	37.57
50368	UT 10-0400/15 AZ	20 ½"	12 ¾"	3 ½"	0.4 AZ	50	48.41
50370	UT 10-0400/15 F-US	20 ½"	12 ¾"	3 ¾"	VCC 10 F US	50	48.41
50372	UT 10-0400/15 STD	20 ½"	12 ¾"	3 ½"	0.4 STD	50	48.41
50374	UT 11-0450/10 AZ	21 7/8"	8 7/8"	3 ½"	0.4 1/3 AZ	50	41.27
50376	UT 11-0450/10 STD	21 7/8"	8 7/8"	3 7/8"	0.4 1/3 STD	50	41.27
50378	UT 11-0450/10 STD	21 ¼"	8 ½"	3 7/8"	VTC 11 US	50	41.27
50380	UT 11-0450/15 AZ	21 7/8"	13 ¼"	3 ½"	0.4 1/3 AZ	63	67.97
50382	UT 11-0450/15 STD	21 7/8"	13 ¼"	3 7/8"	0.4 1/3 STD	63	67.97
51849	UT 12-0475/8 STD	19 ¼"	9 5/8"	4 ¼"	VTC 12 US	58	48.05
50384	UT 12-0475/8 F-US	19 ¼"	9 5/8"	4 7/8"	VTC 12 F US	58	47.17
50387	UT 13-0500/8 AZ	20 7/8"	10 3/8"	3 7/8"	0.5 AZ	56	59.64
50386	UT 13-0500/8 STD	20 7/8"	10 3/8"	4 ½"	0.5 STD	56	59.64
50388	UT 14-0550/8 M	21 ½"	10 5/8"	4 ¼"	VRA 14 US	54	46.12
50390	UT 15-0600/6 AZ	18 ½"	12"	4 5/8"	0.6 AZ	65	61.41
50392	UT 15-0600/6 STD	18 ½"	12"	5 ¼"	0.6 STD	60	56.68
50394	UT 15-0600/6 F-US	18 ½"	12"	5 ¾"	VRA 15 USMXXC 15 F	58	57.24
50396	UT 16-0625/6 F-US	18 7/8"	12 5/8"	7 7/8"	VRA 16 F US	40	45.32
50398	UT 16.5-0650/6 AZ	19 ½"	13"	6 ½"	VCD 16.5	50	59.11
50400	UT 16.5-0650/6 STD	19 ½"	13"	6 ½"	VCC 16.5, VCC 16.5K, VCH 17	50	59.11
51850	UT 16.5 K-0650/6 STD	19 ½"	13"	6 ½"	VCC 16.5, VCC 16.5K, VCH 17	50	59.11
50402	UT 17-0675/6 STD	19 5/8"	13 1/8"	6"	0.6 5/8 STD	50	61.47

Black is standard color; special color options available upon request.

*STD: Standard; AZ: Azalea Version; F: Extra Tall Version; M: Medium Height; K: Self-Aligning

**Gloeckner's Renowned
"5 Petal" Service –
The Best in the
Business!**



VQF (PP) SQUARE POTS *New Listings!*

- *Easy de-nesting* – facet rim and high degree of lateral stability ensure easy de-nesting from the stack in the pot magazine
- *Easily stacked* – posts are stacked using the patented facet rim for error-free stacking
- *Better handling* – U-rim for modern spacing-machine applications; deburred raw edge is user-friendly and reduces the risk of injury
- *Strong hold* – groove profile on all sides provides stability and special shape ensures a strong hold for adhesive labels
- *Recycled materials*: reduced weight, low materials usage

Item #	Mfr #	Width	Height	Case Pk	Price (\$)
Without Tag Lock					
51793	VQF 8x8x8-0315	3 1/8" x 3 1/8"	3 1/8"	2,352	211.07
50291	VQF 8.5x8.5x9.5-0330	3 1/2" x 3 1/2"	3 3/4"	2,352	119.17
50293	VQF 11x11x11.5-0450	4 1/2" x 4 1/2"	4 1/2"	800	76.82
50295	VQF 11x11x15.5-0450	4 1/2" x 4 1/2"	6 1/8"	700	89.75
With Tag Lock					
51788	MQD 9x9x9.5-0350	3 1/2" x 3 1/2"	3 3/4"	880	87.21
51789	MQD 9x9x10-0350	3 1/2" x 3 1/2"	4"	860	93.99
51790	MQD 13x13x13-0500	5" x 5"	5"	396	92.09
Square/Round with Tag Lock					
51791	MQE 11x11x11-0450	4 1/2" x 4 1/2"	4 1/2"	414	59.08
51792	MQE 14x14x14-0550	5 1/2" x 5 1/2"	5"	192	69.09
50053	MQE 16x16x16-0625	6 1/4" x 6 1/4"	6 3/8"	128	57.52

ST TRANSPORT/CULTIVATION TRAYS *New Listings!*

- *Even watering* – Precisely punched overflow holes combined with water channels ensure watering during transport (standard model)
- *Even de-nesting* – evenly formed contours and reliable stacking trays are easy and fast to separate
- *Better handling* – stable soft edge with deburred raw edge is user-friendly and reduces the risk of injury
- *Secure attachment* – punched label holders ensure efficient and secure attachment (select trays)
- *Stability* – special base design for greater stability
- *Packaging* – white stretch film covers protect against UV damage; anti-slip interlayers ensure greater stability during transport
- *Recycled materials*

Item #	Mfr #	Length	Width	Height	Case Pk	Price (\$)
50404	ST1751-8.5 x 8.5/12 BD	20"	6 5/8"	3 1/2"	50	30.60
50406	ST2254-11 x 11/10 AZ-D	21 1/4"	8 1/2"	3 1/8"	56	28.22
50408	ST2254-11 x 11/10 STD-D	21 1/4"	8 1/2"	4 5/8"	54	27.26
50410	ST2551-8.5 x 8.5/18 BD	20"	15"	2 3/4"	31	31.08

The above listed items represent only a small portion of the full-line of Pöppelmann ST Trays, for additional information, contact your Gloeckner representative.



Sophisticated solutions for the best plants, maximum efficiency, and effective resource conservation for over 45 years!

MAN/MAL HANGING BASKETS/HANGERS *New Listings!*

- *Easy de-nesting* – reliable stacking intervals and high degree of stability of the sides ensure easy de-nesting
- *Easily stacked* – stacked using the pot edge for trouble-free stacking
- *Better handling* – Pronounced edge for better handling with automatic spacing systems
- *Reduced labor costs* – perfect hanger fixing for fast and secure installation
- *Reduced transport costs* – Optimal diameter and improved fit increase loading quota per CC container
- *Reduced weight* – low materials usage
- *Fast assembly* – even punched slits for stick tags allow for an automated and rational assembly (*applies to MAL baskets only*)



MAN



MAL

HANGERS *New Listings!*

- *Marketing* – stable hanger ensures secure hanging both in the greenhouse and for the customer
- *Reduced labor costs* – quick and easy hanger assembly due to its universal fixing method
- *Recycled materials; reduced weight*, low materials usage

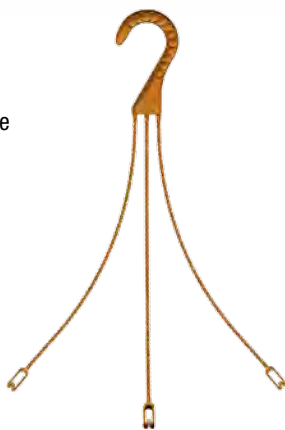

Item #	Mfr #	Dia.	Height	Color	Case Pk	Price (\$)
50325	MAN-20-0800X	8"	5 ¼"	BK	132	68.41
50333	MAN-20-0800X	8"	5 ¼"	CH	132	78.67
50327	MAN-20-0800X	8"	5 ¼"	GR	132	71.83
50331	MAN-20-0800X	8"	5 ¼"	Mocha	132	71.83
50329	MAN-20-0800X	8"	5 ¼"	WH	132	78.67
50335	MAN-25-1000X	10"	6"	BK	116	73.56
50343	MAN-25-1000X	10"	6"	CH	116	82.83
50337	MAN-25-1000X	10"	6"	GR	116	76.65
50341	MAN-25-1000X	10"	6"	Mocha	116	76.65
50339	MAN-25-1000X	10"	6"	WH	116	82.83
50303	MAL-27 Z-1065X	10 ⅝"	6 ½"	BK	50	38.11
50313	MAL-27 Z-1065X	10 ⅝"	6 ½"	CH	50	42.95
50307	MAL-27 Z-1065X	10 ⅝"	6 ½"	GR	50	39.72
50311	MAL-27 Z-1065X	10 ⅝"	6 ½"	Mocha	50	39.72
50309	MAL-27 Z-1065X	10 ⅝"	6 ½"	WH	50	42.95
51837	MAL 33-1300X	13"	7 ½"	BK	N/A	<i>Call for Price</i>
51842	MAL 33-1300X	13"	7 ½"	CH	N/A	<i>Call for Price</i>
51839	MAL 33-1300X	13"	7 ½"	BR	N/A	<i>Call for Price</i>
51841	MAL 33-1300X	13"	7 ½"	Mocha	N/A	<i>Call for Price</i>
51840	MAL 33-1300X	13"	7 ½"	WH	N/A	<i>Call for Price</i>

Custom colors available upon request.

Item #	Mfr #	Size	Color	Case Pk	Price (\$)
50350	MHJ 33-1300X	15 ¼" x 1 ⅝"	BK	352	40.39
50352	MHJ 33-1300X	15 ¼" x 1 ⅝"	GR	352	42.41
50353	MHJ 33-1300X	15 ¼" x 1 ⅝"	WH	352	46.44
50441	MHJ 33-1300X	15 ¼" x 1 ⅝"	Mocha	352	40.63
50442	MHJ 33-1300X	15 ¼" x 1 ⅝"	CH	N/A	<i>Call for Price</i>
50354	MHJ 40-1575X	18" x 1 ⅝"	BK	348	42.69
50356	MHJ 40-1575X	18" x 1 ⅝"	GR	348	44.83
50357	MHJ 40-1575X	18" x 1 ⅝"	WH	348	49.11
50448	MHJ 40-1575X	18" x 1 ⅝"	Mocha	348	42.39
50449	MHJ 40-1575X	18" x 1 ⅝"	CH	348	48.76
51843	MHF 58-2200	22" x 1 ½"	BK	N/A	<i>Call for Price</i>
51845	MHF 58-2200	22" x 1 ½"	GR	N/A	<i>Call for Price</i>
51846	MHF 58-2200	22" x 1 ½"	WH	N/A	<i>Call for Price</i>
51847	MHF 58-2200	22" x 1 ½"	Mocha	N/A	<i>Call for Price</i>
51848	MHF 58-2200	22" x 1 ½"	CH	N/A	<i>Call for Price</i>

Custom colors available upon request.



Specialists in high-quality plant pots, professional cultivation systems, and germination trays for over 45 years!

MDF COVERPOTS *New Listings!*

Featuring attractive labeling, the new MDF Pots are a real eye-catcher and inspire attention in the retail environment.

Coverpots are produced with the *in-mould labeling (IML)* process. In this process the label is attached to the pot during the molding process. After the injection moulding process, the label and the pot become and inseparable unit, guaranteeing a *long-lasting* and *high-quality* appearance.

For an evaluation of your specific needs and corresponding prices, contact your Gloeckner representative.



MDF FOR YOUR LOVED ONES



MDF HERBS



MDF UNIVERSAL



MDF HOLIDAYS

PRINTING & LABELING

A brilliantly printed plant pot actively supports the popularity of your product. What's more, a branded pot creates real value for the gardener, which pays off day after day. From the label to the marketing concept – Pöppelmann's 30 years of horticultural experience and expertise in plastics engineering provide unmatched innovative solutions.

- Flexible print runs
- Extensive color saturation
- Photo printing on black and colored pots
- Error-free coding and scanning

For an evaluation of your specific needs and corresponding pricing, contact your Gloeckner representative.

PDB DECORATIVE POTS *New Listings!*

- *Reduced cultivation time* – assured rapid growth and healthy plants due to ideal watering and drainage
- *Pot in Pot* – the fit enables combination with standard ceramic planters
- *Reduced weight*, low materials usage



Item #	Mfr #	Dia.	Height	Case Pk	Price (\$)
51822	PDB 22-0865	7"	6"	180	113.60
51823	PDB 20-0800	8"	6 2/3"	160	133.00
51824	PDB 22-0865	8 2/3"	7 3/8"	15	15.88
51825	PDB 24-0950	9 1/2"	8"	15	19.15
51826	PDB 26-1025	10 1/4"	8 2/3"	15	23.16
51827	PDB 28-1100	11"	9 3/8"	15	27.47
51828	PDB 32-1260	12 3/8"	10 3/4"	12	30.76
51829	PDB 36-1415	14 1/8"	12"	11	39.63
51830	PDB40-1575	15 3/4"	13 3/8"	10	51.16

T DECORATIVE BOWLS *New Listings!*

- *Low failure rate* – roots not adversely affected or damaged by exposure to light
- *Trouble-free stacking* – stacked using the pot edge
- *Reduced weight*, low materials usage



Item #	Mfr #	Dia.	Height	Case Pk	Price (\$)
51831	T 17-0675	6 5/8"	2 7/8"	80	30.00
51832	T 20-0800	8"	3 3/8"	50	29.28
51833	T 23-0900	9"	3 7/8"	60	46.09
51834	T 27-1065	10 5/8"	4 5/8"	50	65.68
51835	T 30-1200	11 3/4"	5 1/8"	35	58.91
51836	T 35-1375	13 3/4"	6"	30	78.13





The HC Companies™
Leader in Horticultural Containers

We are your leading single source delivering *countless smart solutions for the growing industry™*... from plastic planters and growing pots to nursery containers, garden containers, flats, plug trays and seed starting kits. Plus, we provide growers with unique options in printing and labeling to create vivid in-store displays and brand your plants, while retailers can rely on our merchandising programs to capture consumer attention and sales for our planters and gardening accessories.

**CO-EXTRUDED THERMOFORMED
ROUND POTS**

- Strong rims for efficient use in automated systems
- Lightweight, yet durable polypropylene construction
- Sizes to fit existing benches, carts, and handling systems for added convenience
- Can be customized with offset printing to create unique packaging solutions



Item #	Mfr #	Description	Outside Dia	Height	Color	Tray Compatibility	Case Pk	Price (\$)
46536	XAZ04000	04.00 Azalea Tag Locator Coex Pot	4.00"	3.00"	Green/Black	XTR10400, XTR15400, TCR10401	1,332	110.78
46539	XST04002	04.00 Standard Tag Locator Prop Coex Pot	4.00"	4.00"	Green/Black	XTR15400, XTR10400, TCR10401	1,260	113.02
49026	STT04001	04.00 Standard True Pint	4.00"	3.50"	Green/Black	TRS15409, TRS15400, TRS14400, TCR10400, TCR06400	2,500	153.24
46542	XGR04250	04.25 Geranium Tag Locator Coex Pot	4.25"	4.25"	Green/Black	XTG10430	520	56.68
46545	XAL04251	04.25 Geranium Tall Tag Locator Coex Pot	4.25"	5.38"	Green/Black	TCG10433	640	56.68
46548	XGR04500	04.50 Geranium Tag Locator Coex Pot	4.50"	3.75"	Green/Black	XTG15450, XTG12450, XTG10450, TCG10450	720	77.90
49872	STT04501	04.50 Standard Pot	4.50"	3.75"	Green/Black	TCG10450, TRS10450, TRS12450, TRS15450, TRS15459	1,960	169.40
46554	XAZ05000	05.00 Azalea Short Coex Pot	5.00"	3.75"	Green/Black	TCA08503	675	101.25
46557	XAL05000	05.00 AZ Tall Coex Pot	5.00"	5.75"	Green/Black	TRS5T800	600	190.36
46361	XAZ05500	05.50 AZ Traditional Coex Pot	5.25"	4.50"	Green/Black	TCA08551, TCA06551, TIS55080	496	88.33
46364	XAZ06001	06.00 Azalea Coex Pot	5.90"	4.25"	Green/Black	TCA06605, TIS060060, TIS60061	864	129.77
46551	XNT0TQT2	01.00 Quart Perennial Pot Prop Coex Pot	4.62"	5.25"	Green/Black	TRS12QD0, TRS10QD0, TRS10QD3, TRS10QD5, TCR081Q5, TCR081Q3	432	68.71
46563	EU150S70	15 CM Euro Short Mum Pot	6.00"	4.50"	Green/Black	TRS06150	760	114.06
46566	EU150T50	15 CM Euro Pot	6.00"	5.12"	Green/Black	TRS06151	500	93.03
46569	EU17S50	17 CM Euro Short Mum Pot	6.62"	5.00"	Green/Black	TRS06171	300	67.07
46572	EU170T50	17 CM Euro Thermo Pot	6.62"	6.00"	Green/Black	TRS06170	294	79.59
46575	EU190S51	19 CM Euro Co-ex Short	7.50"	5.75"	Green/Black	YAT03190, YAT03191	220	58.21
46578	EU190T51	19 CM Euro Co-ex Tall	7.50"	7.37"	Green/Black	TIS19020	132	56.66
46581	EU210S50	21 CM Euro Short Mum Pot	8.00"	5.00"	Green/Black		230	94.23
46584	EU210M50	21 CM Euro Medium Mum Pot	8.00"	6.00"	Green/Black		210	86.89
46587	EU210T50	21 CM Euro Tall Pot	8.00"	7.25"	Green/Black		190	103.41
46367	XAM08000	08.00x05.00 Mum Pan Coex Pot	8.00"	5.00"	Green/Black		170	57.54
46590	XAM09001	09.00 x 06.25 Mum Pan Coex Pot	9.00"	6.25"	Green/Black	TVM09200	90	38.46
46560	XSQM60S0	M6 Square Short Coex	5.00"	4.50"	Green/Black	TCS08M60, TIA05500	585	121.10
46370	XSQ00M60	M6 Square Coex	5.00"	5.37"	Green/Black	TCS08M60	468	136.98

Terra Cotta/Black and Black/Black available upon request. Please refer to page 16 for helpful matching tray illustrations.
Bulk Quantities at discounted prices available upon request.



Minimum order of 10 cases for all HC products.

MATCHING TRAYS FOR CO-EX POTS

- Variety of sizes to fit a wide range of benches, carts, and handling systems
- Durable and rigid construction delivers consistent handling performance
- Designed to work on roller conveyers and automated potting systems
- Works well in automated tray dispensers



Item #	Mfr #	Description	Length	Width	Height	Color	Pot Compatibility	Case Pk	Price (\$)
46357	TCR06400	6 Pocket Round Carry Tray for 04.00 Pot (CTR46)	12.00"	8.00"	3.75"	BK	STT04001	100	114.85
46610	XTR10400	10 Pocket Tray for 04.00 Coex Pot (CTXR410)	20.62"	8.25"	4.00"	BK	XST04002, XAZ04000	50	65.24
46355	TCR10400	10 Pocket Round Carry Tray For 04.00 Pot	20.00"	8.00"	3.63"	BK	STT04001	50	58.09
49962	TCR10401	10 Pocket Round Carry Tray for 04.00 Coex Pot (CTR10CX)	20.00"	8.00"	3.63"	BK	XST04002	50	58.09
46663	XTR15400	15 Pocket Tray for 04.00 Coex Pot (CTXR415)	20.55"	12.29"	4.00"	BK	XST04002	50	73.80
49873	TRS14400	14-Pocket Tray For 4" AZ & STD Round Pots	20.37"	11.12"	3.63"	BK	XNT0TQT2	50	61.72
49032	TRS15409	15-Pocket Tray For 4" AZ & STD Round Pots	20.25"	12.12"	3.63"	BK	STT04001	50	88.26
49875	TRS10430	10-Pocket Tray For 4.25" AZ & STD Round Pots	22.00"	8.87"	4.00"	BK	STT04250	50	65.81
46605	TCG10433	10 Pocket Tray for 04.25 Geranium Coex Tall Tray (CTG42510 CX)	21.25"	8.50"	5.38"	BK	XAL04251	50	67.58
46604	XTG10430	10 Pocket Tray for 04.25 Coex Pot (CTXG42510)	21.00"	8.50"	5.50"	BK	XGR04250	50	66.24
49874	TCG10450	10 Count Offset Tray for 4.5 Geranium	21.25"	8.50"	5.38"	BK	XGR04500, STT04501, STG04500, STG04501, STD04500	50	68.18
49876	TRS10450	10 Pocket Tray For 4.5" AZ & STD Round Pots	23.25"	9.37"	4.00"	BK	XGR04500, STT04501	50	71.71
49877	TRS15459	15-Pocket Tray For 4.5" AZ & STD Round Pots	22.50"	13.75"	4.00"	BK	STT04501	50	99.17
49885	TRS15450	15-Pocket Tray For 4.5" AZ & STD Pots No Rib	22.50"	13.75"	4.00"	BK	STT04501	50	94.67
46606	XTG10450	10 Pocket Tray for 04.50 Coex Pot (CTXG4510)	23.00"	9.50"	3.75"	BK	XGR04500	50	70.67
46607	XTG12450	12 Pocket Tray for 04.50 Coex Pot (CTXG4512)	18.50"	14.00"	3.75"	BK	XGR04500	50	96.67
46608	XTG15450	15 Pocket Tray for 04.50 Coex Pot (CTXR4515)	23.00"	14.00"	3.75"	BK	XGR04500	50	103.99
49898	TCG10450	10-Count Tray for 4.5 Geranium	21.25"	8.50"	5.38"	BK	XGR04500, STT04501, STG0450, STG04501, STD04500	50	71.96
49879	TCA08503	8 Pocket Azalea Carry Tray For 05.00 Coex Azalea	19.87"	9.87"	3.75"	BK	XAZ05000	50	76.42
46603	TRS5T800	8 Pocket Tray For 05.00 Tall Coex Pot	18.87"	8.80"	5.75"	BK	XAL05000	50	80.16
46088	TCA06551	6 Pocket Azalea Carry Tray For 05.50 Coex Azalea	20.00"	10.00"	4.50"	BK	XAZ05500	50	74.65
46089	TCA08551	8 Pocket Azalea Carry Tray For 05.50 Coex Azalea	22.00"	11.00"	4.62"	BK	XAZ05500	50	93.07
46090	TCA06605	6 Pocket Azalea Carry Tray For 06.00 Coex Azalea	18.50"	12.37"	4.25"	BK	XAZ06001	50	78.93
46349	TCR081Q3	8 Pocket Staggered Round Quart Tray 1 Quart Coex Pot	20.00"	9.50"	4.75"	BK	XNT0TQT2	50	77.08
46353	TCR081Q5	8 Pocket Round Quart Tray For 1 Quart Coex Pot (CTQ8RCX)	19.50"	10.00"	4.75"	BK	XNT0TQT2	50	66.75
46133	TIS60060	6/6/10 Injection Spacer Tray 1 Shut Tray	21.00"	13.75"	2.50"	BK	XAZ06001	25	62.77
46136	TIS60061	6/6/10 Injection Spacer Tray 2 Shut Tray	21.00"	13.75"	2.50"	BK	XAZ06001	25	69.94

Bulk Quantities at discounted prices available upon request.



Minimum order of 10 cases for all HC products.

THINWALL POTS

- Largest selection of injection-molded pots in the industry
- Multiple options in style, size, color, and packaging
- Made from high-grade polypropylene
- Can be customized with offset printing to meet customers' needs



Item #	Mfr #	Description	Outside Dia	Height	Color	Tray Compatibility	Case Pk	Price (\$)
Thinwall Rounds								
46401	STG03500	03.50 Standard Tag Locator Thinwall	3.50"	3.25"	BK	TCR12350	1,225	137.28
46403	AZG04000	04.00 Azalea Thinwall	4.00"	2.87"	BK	TRS15400 TCA15400 TIS40100 TIS40101	1,980	228.62
46407	STG04000	04.00 Standard Thinwall	4.00"	3.50"	BK	TRS15400, TCR10400, TCR06400	1,550	174.51
49963	STD04000	04.00 Regal Standard Dual Drain	4.00"	3.50"	BK	TRS15409, TRS15409, TRS14400, TRS10400, TCW10400	1,320	150.59
46409	STG04253	04.25 Geranium Tag Locator Thinwall	4.25"	4.09"	BK	TCG08430, TCG10430	680	85.30
46411	STG04500	04.50 Geranium Thinwall	4.50"	3.81"	BK	TCG15450, TCG12450, TCG08450	850	115.81
46394	STG04501	04.50 Geranium Tag Locator Thinwall	4.50"	3.81"	BK	TCG15450, TCG12450, TCG08450	850	116.24
51754	STD04500	04.50 Regal Stanrard Dual Drain	4.50"	3.75"	BK	TRS15450 (K), TRS15450, TRS15450, TRS15459 (K), TRS15459, TRS15459, TCG12450, TRS10450, TRS10450	1,000	156.50
46418	AZM06000	05.50 Azalea Traditional Thinwall	5.50"	4.56"	BK	TCA08550, TCA06550	544	139.55
46415	AZG05001	05.00 Azalea Tag Locator Thinwall	5.00"	3.62"	BK	TCA08500	792	151.81
49880	AZE06000	06.00 Elite/Ultra Azalea	6.00"	4.25"	BK	TRS066E0	520	107.38
46422	AZG06000	06.00 Azalea Thinwall	6.00"	4.25"	BK	TCA06600, TCA06604, TCW06600	560	115.65
46420	AZJ06001	06.00 Azalea Jumbo Thinwall	6.06"	4.93"	BK	TCA06602 TIS60060 TIS60061 TIS60060	528	183.11
49881	AZD06000	06.00 Regal Azalea	6.00"	4.62"	BK	TRS066R0	500	112.92
46424	STG06000	06.00 Standard Thinwall	6.00"	5.75"	BK	TCR06600	440	149.30
49882	AZE06500	6.50 Elite Azalea	6.50"	4.62"	BK	TRS06650	504	147.36
46376	AZN06501	06.50 Azalea Traditional Thinwall	6.50"	4.93"	BK	TCA665J2	240	94.21
49883	NRT0T1G3	01.00 T1G 2 WD Tag Locator	6.50"	7.00"	BK	TCR06TGO, TCF06SG0, TRPTGAL0, TCW03TGO	128	82.33
49027	AZE07000	07.00 Elite Ultra Azalea	7.00"	5.00"	BK		250	143.23
49028	AZE07500	07.50 Elite Ultra Azalea	7.50"	5.50"	BK		200	110.55
49029	AZE08000	08.00 Elite Ultra Azalea	8.00"	5.62"	BK		270	169.43
46388	AZG08501	08.50 Azalea Thinwall With Slot	8.31"	5.81"	BK		130	134.90
46390	AZM09000	09.00 x 06.50 Mum Pan Thinwall	9.00"	6.56"	BK		54	54.45
46374	AZG10000	10.00 Azalea Thinwall	10.00"	7.50"	BK		90	137.64
46596	STS10000	10.00 STD Stock Thinwall	10.00"	8.75"	BK		72	111.78
Thinwall Squares								
46430	SQL03501	3.50 Square Deep Perennial Tag Locator	3.37"	3.93"	BK	TCS18350, TCS12330	832	165.46
46599	SQK04001	4.00 Square Tag Locator Thinwall	3.96"	3.62"	BK	TRK15400, TRK15400 (K), TCS15401, TRK10400	846	143.09
46434	SQA04000	4.00 Square Traditional Thinwall	3.87"	3.37"	BK	TCS15400	900	190.27
46600	SQK04500	4.50 Square Thinwall	4.18"	3.81"	BK		405	82.19
46601	SQK04501	4.50 Square Tag Locator Thinwall	4.18"	3.81"	BK	TCS15452, TCS10452	510	115.82
46437	SQA04500	4.50 Square Traditional Thinwall	4.12"	3.50"	BK	TCS15450	765	194.86
46439	SQL04501	4.50 Square Deep Perennial Tag Locator	4.21"	4.93"	BK	TCS15452, TCS10450	441	144.02
46440	SQL05501	5.50 Square Deep Perennial Tag Locator	5.25"	5.93"	BK	TCS08550	256	144.65
46441	SQJ05502	5.50 Square Jumbo Tag Locator Thinwall	5.03"	5.62"	BK	TCS08M60	288	137.95

Bulk Quantities at discounted prices available upon request.

Minimum order of 10 cases for all HC products.

MATCHING TRAYS FOR THINWALL POTS

- Extensive selection of tray systems for both round and square pots
- Durable, rigid construction delivers consistent performance from grower to retailer
- Automation-friendly designs
- Locator Locks (LL) lock pots uniformly in the tray for displaying stick tags and printed graphics at retail



Item #	Mfr #	Description	Length	Width	Height	Color	Pot Compatibility	Case Pk	Price (\$)
Round Pot Trays									
46354	TCR12350	12 Pocket Round Carry Tray For 03.50 Pot	21.25"	7.12"	3.50"	BK	STG03500	50	62.90
46357	TCR06400	6 Count Carry Tray for 04.00 Pot w/Handle	12.00"	8.00"	3.75"	BK	STT04000, STD04001	100	114.85
46355	TCR10400	10-Pocket Tray for 4.00 Pot	20.00"	8.00"	3.62"	BK	STG04000	50	58.09
49884	TRS10400	10-Pocket Tray For 4" AZ & STD Round Pots	20.25"	8.12"	3.62"	BK	STD04000	50	64.05
49873	TRS14400	14-Pocket Tray For 4" AZ & STD Round Pots	20.37"	11.12"	3.62"	BK	STD04000, STT040001	50	61.72
49031	TRS15400	15-Pocket Tray For 4" AZ & STD Round Pots No Rib	22.00"	12.25"	3.56"	BK	STG04000, AZG04000, STT04001	50	94.67
49032	TRS15409	15-Pocket Tray For 4" AZ & STD Round Pots	20.25"	12.12"	3.62"	BK	STD04000, STT040001	50	88.26
46168	TCG08430	8 Pocket Geranium Carry Tray for 04.25 Pot (Spaced)	20.00"	10.00"	4.25"	BK	STG04253	50	65.47
46167	TCG10430	10 Pocket Geranium Carry Tray For 04.25 Pot	21.50"	8.37"	4.25"	BK	STG04253	50	73.35
46171	TCG08450	8-Pocket Geranium Carry Tray for 04.50	19.62"	10.00"	4.00"	BK	STG04500, STG04501	50	69.74
46169	TCG12450	12-Pocket Geranium Carry Tray for 04.50 Pot	18.25"	14.00"	3.75"	BK	STG04500, STG04501	50	89.11
49876	TRS10450	10-Pocket Tray for 4.5" AZ & STD Round Pots	23.25"	9.37"	4.00"	BK	AZE04500, STD4500	50	71.71
49885	TRS15450	15-Pocket Tray for 4.5" AZ & STD Round Pots No Rib	22.50"	13.75"	4.00"	BK	AZE04500, STD4500	50	106.38
49877	TRS15459	15-Pocket Tray for 4.5" AZ & STD Round Pots	22.50"	13.75"	4.00"	BK	AZE04500, STD4500	50	75.19
46170	TCG15450	15-Pocket Geranium Carry Tray for 4.50 Pot	22.75"	13.75"	4.00"	BK	STG04500, STG04501	50	95.51
46094	TCA08500	8 Pocket Azalea Carry Tray For 05.00 Azalea	19.87"	9.87"	3.75"	BK	AZG05001	50	87.76
46092	TCA06550	6 Pocket Azalea Carry Tray For 05.50 Azalea (Staggered)	20.00"	10.00"	4.50"	BK	AZM06000	50	79.54
46093	TCA08550	8 Pocket Azalea Carry Tray For 05.50 Azalea	22.00"	11.00"	4.62"	BK	AZM06000	50	89.01
46358	TCR06600	6-Pocket Round Carry Tray for 6.00 Pot	18.50"	12.37"	5.00"	BK	STG06000, XST06000	50	78.51
49886	TCW06600	6-Pocket Dillen Watering Tray for 06.00 Azalea Pot	20.25"	13.25"	2.75"	BK	AZG06000	50	86.04
49887	TRS066E0	6 Pocket Tray For 6" Elite Round Pots	18.00"	12.00"	4.25"	BK	AZE06000	50	77.72
46095	TRS066R0	6-Pocket Tray For 6" AZ Round Pots	18.25"	12.12"	5.12"	BK	AZD06000, AZD06002	50	81.62
46096	TCA06600	6 Pocket Azalea Carry Tray For 06.00 Azalea	18.50"	12.37"	4.37"	BK	AZG06000	50	77.10
46101	TCA06602	6 Pocket Azalea Carry Tray For 06.00 Jumbo Azalea	18.50"	12.37"	4.75"	BK	AZJ06001	50	89.01
46097	TCA06604	6 Pocket Azalea Carry Tray for 06.00 Azalea or Coex Staggered	20.00"	11.25"	4.25"	BK	AZG06000, XAZ06001	50	109.58
46133	TIS60060	6/6/10 Injection Spacer Tray 1 Shut Tray	21.00"	13.75"	2.50"	BK	XAZ06001, XST06000, AZM06000, AZE06000, AZE06001, AZJ06001, AZD06000, AZD06002, AZD06002	25	62.77
46100	TCA665J2	6 Pocket Azalea Carry Tray For 06.50 Azalea Jumbo	19.18"	13.25"	5.00"	BK	AZN06501	50	104.07
Square Pot Trays									
46339	TCS12330	12 Pocket Square Carry Tray For 03.25 Pot	19.50"	6.62"	1.87"	BK	SQL03501	100	112.70
46609	TCS18350	18 Pocket Square Carry Tray For 03.50 Pot	19.87"	9.87"	1.87"	BK	SQL03501	50	72.69
49888	TRK10400	Kord 10-Pocket Tray For 04.00 Pot	20.00"	8.00"	2.25"	BK	SQK04001	50	57.08
46340	TCS15400	15 Pocket Square Carry Tray For 04.00 Trad Pot	19.50"	11.75"	3.37"	BK	SQA0A400	50	94.35
49889	TRK15400	Kord 15-Pocket Tray For 04.00 Pot	20.25"	12.25"	2.00"	BK	SQK04001	50	75.04

Continued on next page.

Minimum order of 10 cases for all HC products.

MATCHING TRAYS FOR THINWALL POTS – *continued*

Item #	Mfr #	Description	Length	Width	Height	Color	Pot Compatibility	Case Pk	Price (\$)
Square Pot Trays – <i>continued</i>									
46337	TCS15401	15 Pocket Square Carry Tray For 04.00 Pot (Locator Lock)	20.25"	12.25"	2.00"	BK	SQK04001	50	86.25
46341	TCS10450	10 Pocket Square Carry Tray For 04.50 Pot (Short Ribbed)	21.00"	8.50"	3.00"	BK	SQL04501	50	65.85
46458	TCS10452	10 Pocket Square Carry Tray For 04.50 Pot (Press Fit)	21.25"	8.62"	2.00"	BK	SQK04501	50	69.07
46338	TCS15452	15 Pocket Square Carry Tray For 04.50 Pot (Press Fit)	21.25"	13.00"	2.00"	BK	SQL04501	50	83.80
46342	TCS15450	15 Pocket Square Carry Tray For 04.50 Pot	20.62"	12.50"	3.50"	BK	SQA04500	50	88.18
46343	TCS08550	8 Pocket Square Carry Tray For 05.50 Pot	21.25"	10.62"	3.87"	BK	SQL05501	50	70.91
46344	TCS08M60	8 Pocket Square Carry Tray For 06.00 Pot	19.75"	9.87"	3.75"	BK	SQJ05502	50	65.82

Bulk Quantities at discounted prices available upon request. Please see below for helpful matching tray illustrations.

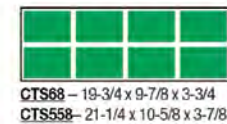
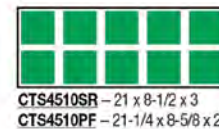
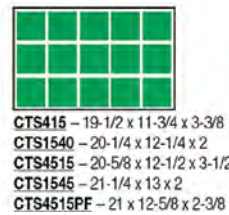
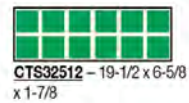
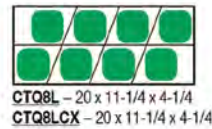
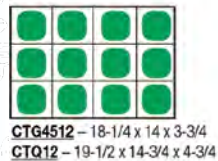
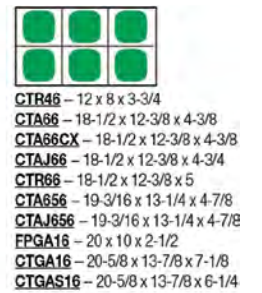
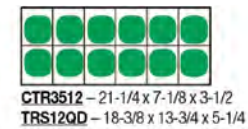
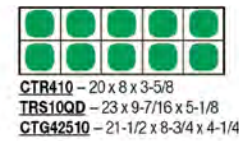
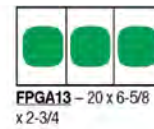
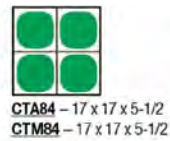
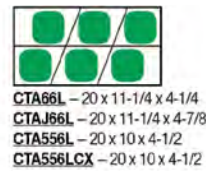
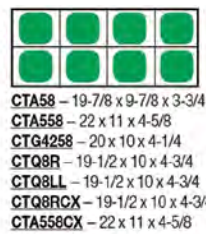
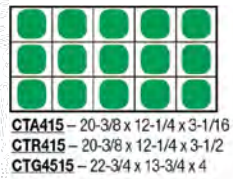

Minimum order of 10 cases for all HC products.



VACUUM PLUG TRAYS

- Ideal for seed germination or vegetative propagation
- Precision punched holes guarantee optimal drainage and air pruning performance
- Trays available with stacking notches for quick and easy de-nesting in automated equipment

Item #	Description	Length	Width	Height	Cell Dia. Top	Color	Configuration	Case Pk	Price (\$)
True Plug Trays									
46646	TVPT84SQ (W/TAG RAMP) VT	20"	10"	1 3/4"	1 1/16"	BK	7 x 12	50	63.34
46308	TVPT144RD VT, S	20"	10"	1 5/8"	1 5/16"	BK	8 x 18	50	63.34
46309	TVPT144SQ VT, S	20"	10"	1 5/8"	7/8"	BK	8 x 18	50	63.34
46310	TVPT288SQ, S	20"	10"	1 1/8"	3/4"	BK	12 x 24	50	62.57
Standard Plug Trays									
46305	DVPT51HX VT	21"	5 1/4"	1 1/16"	1 1/16"	BK	3 x 17	50	84.45
46301	DVPT102HX VT, S	21"	10 1/2"	1 1/16"	1 1/16"	BK	6 x 17	50	64.89
46647	DVPT105HX E VT	20 3/4"	10 1/4"	1 3/4"	1 1/16"	BK	7 x 15	50	64.89
46303	DVPT128SQ VT	20 3/8"	10 1/4"	1 9/16"	1 5/16"	BK	8 x 16	50	64.89
46648	DVPT128RD	10 3/8"	10 1/4"	1 1/4"	1 5/16"	BK	8 x 16	50	76.71
46302	DVPT288CE	20 1/2"	10 1/4"	1 1/16"	1 3/16"	BK	12 x 24	50	64.89
46306	DVPT512CE	20 1/2"	10 1/4"	7/8"	9/16"	BK	16 x 32	50	64.89

S=Seasonal Availability; BK=Black; CE=Common Element; DVPT=Standard Vacuum Plug Tray; E=Endless; HD=Heavy Duty; HX=Hexagon; SQ=Square Cell; TVPT=True Vacuum Plug Tray; VT=Ventilated

Bulk Quantities at discounted prices available upon request.



VACUUM POTS & COMPATIBLE TRAYS

- Economic alternative to single pots
- Perforated for easy pot separation at retail or uncut for landscape applications
- Smooth finish ideal for easy label adhesion

Vacuum Pots

Item #	Description	Inside Dia	Outside Dia	Height	Color	Tray Compatibility	Case Pk	Price (\$)
46445	DSQVP3PF/D (03.00 SQ DEEP VAC POT PRESS FIT)	2 7/16"	2 5/8"	3 1/2"	BK	CTS332PF(V)	800	54.24
46446	DSQVP325/D (03.25 SP DEEP VAC POT)	3 1/8"	3 1/4"	3 5/8"	BK	CTS32518PF(V)	1200	91.48
46447	DSQVP325PF/D (03.25 SQ DEEP VAC POT PRESS FIT)	3 1/8"	3 1/4"	3 5/8"	BK	CTS32518PF(V)	450	45.48
46453	DSQVP4PF/D (04.00 SQ DEEP VAC POT PRESS FIT)	3 5/16"	3 1/2"	3 1/2"	BK	CTS418PF(V)	450	47.07
46448	DSQVP45PF (04.50 SQ DEEP VAC POT PRESS FIT)	4"	4 1/2"	3 5/8"	BK	CTS4510PF(V)	250	34.33
46449	DSQVP45PF (04.50 SQ DEEP VAC POT PRESS FIT)	4"	4 1/2"	3 5/8"	BK	CTS4512PF(V)	300	42.02
46450	DSQVP45PF (04.50 SQ DEEP VAC POT PRESS FIT)	4"	4 1/2"	3 5/8"	BK	CTS4515PF(V)	375	52.53
46451	DSQVP45PF/D (04.50 DQ DEEP VAC POT PRESS FIT)	4"	4 1/8"	5"	BK	CTS4512PF(V)	300	49.20
46452	DSQVP45PF/D (04.50 DQ DEEP VAC POT PRESS FIT)	4"	4 1/8"	5"	BK	CTS4515PF(V)	375	61.50

BK=BLACK; CTS=CARRY TRAY SQUARE; DSQVP=DILLEN SQUIRE VACUUM POT; /D=DEEP; PF=PRESS FIT; (V)=VACUUM

Square Press Fit Trays

Item #	Description	Length	Width	Height	Color	Pot Compatibility	Case Pk	Price (\$)
46455	CTS325PF (PRESS FIT), S	13 1/2"	13 1/2"	2 5/8"	BK	DSQVP3PFD(V) X 25	50	85.16
46456	CTS332PF (PRESS FIT)	21 1/8"	10 5/8"	1 7/8"	BK	DSQVP3PFD(V) X 32	50	67.24
46454	CTS32518PF (PRESS FIT)	19 7/8"	9 7/8"	1 7/8"	BK	DSQVP325PFD(V) X 18	50	59.55
46457	CTS418PF (PRESS FIT)	21 1/4"	10 5/8"	2 3/8"	BK	DSQVP4PFD(V) X 18	50	64.11
46458	CTS4510PF (PRESS FIT)	21 1/4"	8 5/8"	2"	BK	DSQVP45PF	50	68.35
46459	CTS4512PF (PRESS FIT)	16 3/4"	12 1/2"	2 3/8"	BK	DSQVP45PF(V) X 12; DSQVP45PFD(V) X 12	50	80.36
46460	CTS4515PF (PRESS FIT)	21"	12 5/8"	2 3/8"	BK	DSQVP45PF(V) X 15; DSQVP45PFD(V) X 15	50	74.96

S=Seasonal Availability; BK=Black; CTS=Carry Tray Square; DP=Deep; DSQVP=Dillen Squire Vacuum Pot; (I)=Injection; PF=Press Fit; STD=Standard; SQ=Square; TL=Tag Locator; TW=Thinwall; (V)=Vacuum; VAC=Vacuum

Sheet of Pots

Item #	Description	Length	Width	Height	Color	Compatibility	Case Pk	Price (\$)
46325	AS4510	21 5/8"	8 1/4"	4"	BK		50	68.33
46329	PS4510TL	21 5/8"	8 1/4"	5"	BK	CTS4510SR(V)	50	72.54
46330	TPS1801 CUT	20"	10"	3 1/2"	BK	TV1020P18(V), T SERIES OPEN FLATS (V)&(I)	100	56.97
46326	DPS1801 CUT	21"	10 1/2"	3 1/2"	BK	CTS418PF(V), D SERIES OPEN FLATS (V)&(I)	100	88.32
46327	DPS1801 UNCUT	21"	10 1/2"	3 1/2"	BK	CTS418PF(V), D SERIES OPEN FLATS (V)&(I)	100	132.94
46328	PS1501 DEEP	20 3/4"	12 1/2"	4 3/4"	BK	CTS4515(V)	50	99.06

AS=Annual Sheet; BK=Black; CTS=Carry Tray Square; D=Standard; DPS=Standard Perennial Sheet; (I)=Injection; PF=Press Fit; PS=Perennial Sheet; T=True; TL=Tag Locator; (V)=Vacuum

Bulk quantities at discounted prices available upon request. Custom colors available upon request.

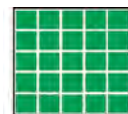

CTS325PF - 13-1/2 x 13-1/2 x 2-5/8



CTS332PF - 21-1/8 x 10-5/8 x 1-7/8



CTS32518PF - 19-7/8 x 9-7/8 x 1-7/8
 CTS418PF - 21-1/4 x 10-5/8 x 2-3/8
 TPS1801 - 20 x 10 DPS1801 - 20 x 10



CTS4510SR - 21 x 8-1/2 x 3
 CTS4510PF - 21-1/4 x 8-5/8 x 2

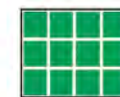

CTS4512PF - 16-3/4 x 12-1/2 x 2-3/8



CTS4515 - 19-1/2 x 11-3/4 x 3-3/8
 CTS1540 - 20-1/4 x 12-1/4 x 2
 CTS4515 - 20-5/8 x 12-1/2 x 3-1/2
 CTS1545 - 21-1/4 x 13 x 2
 CTS4515PF - 21 x 12-5/8 x 2-3/8
 PS1501 - 20-3/4 x 12-1/2



CTS32512 - 19-1/2 x 6-5/8 x 1-7/8



CTS314 - 18-1/4 x 5-1/4 x 2-1/2

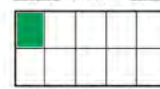

4510 AS - 21-5/8 x 8-1/4
 PS(TL) - 21-5/8 x 8-1/4

Minimum order of 10 cases for all HC products.

VACUUM INSERTS

- High-quality, specially-blended polystyrene material
- Designed to optimize performance in automated handling systems – ideal for filling, growing, and shipping

- Exact sheet thickness for strong corner and cell bottom construction
- Precision burned holes and die-cut trims deliver consistent performance
- Optional labeling to display plant information and UPCs available upon request

Item #	Description	Length	Width	Height	Color	Configuration	Case Pk	Price (\$)
Standard Inserts								
46250	D606	21"	10 1/2"	2 1/4"	BK	Standard Inserts Fit Most Standard Injection & Vacuum Flats	100	56.97
46256	DJ606 (JUMBO)	21"	10 1/2"	3 1/4"	BK	Standard Inserts Fit Most Standard Injection & Vacuum Flats	100	65.20
46251	D801	21"	10 1/2"	2 1/4"	BK	Standard Inserts Fit Most Standard Injection & Vacuum Flats	100	63.79
46252	D804	21"	10 1/2"	2 1/4"	BK	Standard Inserts Fit Most Standard Injection & Vacuum Flats	100	59.41
46253	D806	21"	10 1/2"	2 1/4"	BK	Standard Inserts Fit Most Standard Injection & Vacuum Flats	100	59.41
46254	D806R	21"	10 1/2"	2 1/4"	BK	Standard Inserts Fit Most Standard Injection & Vacuum Flats	100	59.41
46255	D809, S	21"	10 1/2"	2 1/4"	BK	Standard Inserts Fit Most Standard Injection & Vacuum Flats	100	63.79
46244	D1201	21"	10 1/2"	2 1/4"	BK	Standard Inserts Fit Most Standard Injection & Vacuum Flats	100	64.41
46245	D1202	21"	10 1/2"	2 1/4"	BK	Standard Inserts Fit Most Standard Injection & Vacuum Flats	100	63.79
46246	D1203	21"	10 1/2"	2 1/4"	BK	Standard Inserts Fit Most Standard Injection & Vacuum Flats	100	59.41
46247	D1204	21"	10 1/2"	2 1/4"	BK	Standard Inserts Fit Most Standard Injection & Vacuum Flats	100	59.41
46248	D1206	21"	10 1/2"	2 1/4"	BK	Standard Inserts Fit Most Standard Injection & Vacuum Flats	100	56.51
46249	D1801	21"	10 1/2"	2 1/4"	BK	Standard Inserts Fit Most Standard Injection & Vacuum Flats	100	62.24
True Inserts								
46265	T804	20"	10"	2 1/2"	BK	True Inserts Fit Most True Injection & Vacuum Flats	100	58.46
46266	T806	20"	10"	2 1/2"	BK	True Inserts Fit Most True Injection & Vacuum Flats	100	59.92
46267	T806R	20"	10"	2 1/2"	BK	True Inserts Fit Most True Injection & Vacuum Flats	100	59.92
46258	T1201	20"	10"	2 1/2"	BK	True Inserts Fit Most True Injection & Vacuum Flats	100	60.06
46259	T1203	20"	10"	2 1/2"	BK	True Inserts Fit Most True Injection & Vacuum Flats	100	60.51
46615	T1203R	20"	10"	2 1/2"	BK	True Inserts Fit Most True Injection & Vacuum Flats	100	59.92
46260	T1204	20"	10"	2 1/2"	BK	True Inserts Fit Most True Injection & Vacuum Flats	100	58.46
46261	T1206	20"	10"	2 1/2"	BK	True Inserts Fit Most True Injection & Vacuum Flats	100	59.92
46268	TJ606 (JUMBO)	20"	10"	3 1/4"	BK	T1020R6(I), TVF1020R6(V)	100	60.57
46263	T306BP(H) (TRUE 6 CELL SINGLE BASKET PACK)	10"	6 3/4"	3 1/2"	WH	Accepts DPC Handle 2, Basket Pack Clip Handle (I), TV1020R3(V)	300	139.78
46616	DPC UTILITY HANDLE 2	16 1/4"	N/A	N/A	WH	For T306BP(H)(V), T224HP(H)(V), HPT108(H)(V), SJ224HP (H)(V), HPSJ120(H)(V)	1000	175.23
46617	DPC UTILITY HANDLE 3	20"	N/A	N/A	WH	For T306BP(H)(V), T224HP(H)(V), HPSJ120(H)(V)	1000	210.66
46618	BASKET PACK CLIP HANDLE, S	21 1/2"	N/A	N/A	WH	T306BP(V), HPSM109(V), SM306BP(V)	1000	136.35

S=Seasonal Availability; AS=Annual Sheet; BK=Black; BP=Basket Pack; D=Standard; H=Handle Hole; HP=Half Pack; I=Injection; JS=Jumbo Short; L=Long; PS=Perennial Sheet QP=Quarter Pack; R=Reverse; S=Short; SJ=Slim Jim; SM=Skinny Minnie; SMJ=Skinny Minnie Jumbo; ST=Super Thin; T=True; TV=True Vacuum; (V)=Vacuum; WH=White

Bulk Quantities at discounted prices available upon request. Shipped in corrugated boxes or bulk with a weather-proof wrap to prevent damage.

Slim Jim, Skinny Minnie and Super Thin inserts available upon request.



Minimum order of 10 cases for all HC products.

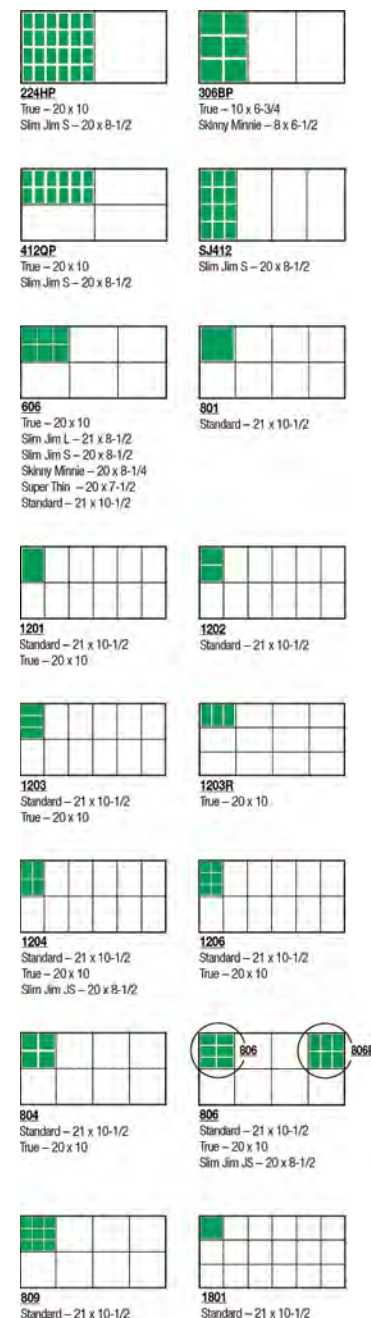

VACUUM FLATS

- Flats are constructed from sturdy gauge material for durability
- Flats are available in a variety of rib configurations to fit any growing need
- Available in an assortment of shallow, full depth and short styles

Item #	Description	Length	Width	Height	Color	Compatibility	Case Pk	Price (\$)
Standard Flats								
46619	DVF1020 NO HOLE	21"	10 ½"	2 ¾"	BK	D Series Inserts	100	115.75
46147	DVF1020/R	21"	10 ½"	2 ¾"	BK	D Series Inserts	100	115.75
46149	DVF1020/R8	21"	10 ½"	2 ¾"	BK	D Series Inserts	100	122.66
46148	DVF1020/R6	21"	10 ½"	2 ¾"	BK	D Series Inserts	100	129.24
True Flats								
46150	TV1020R3	20"	10"	2"	BK	T306BP(H) x 3(V)	100	124.14
46151	TVF1020	20"	10"	2 5/8"	BK	T Series Inserts	100	106.99
46152	TVF1020/R	20"	10"	2 5/8"	BK	T Series Inserts	100	111.15
46155	TVF1020/R8	20"	10"	2 5/8"	BK	T Series Inserts	100	108.70
46153	TVF1020/R12	20"	10"	2 5/8"	BK	T Series Inserts	100	108.70
46154	TVF1020R6	20"	10"	2 5/8"	BK	T Series Inserts	100	108.70

BK=Black; DVF=Standard Vacuum Full Depth; H=Handle Hole; R=Ribs; T=True; TV=True Vacuum; TVF=True Vacuum Full Depth; V=Vacuum
Slim Jim and Skinny Minnie Vacuum Flats are available upon request.



No Ribs
STD – 21 x 10-1/2 x 2-3/8
True – 20 x 10 x 2
True F – 20 x 10 x 2-5/8
Slim Jim S – 20 x 8-1/2 x 2-1/2



R
STD – 21 x 10-1/2 x 2-3/8
True – 20 x 10 x 2
True F – 20 x 10 x 2-5/8



R3
True – 20 x 10 x 2

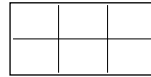

R6
STD – 21 x 10-1/2 x 2-3/8
True – 20 x 10 x 2
True F – 20 x 10 x 2-5/8

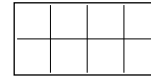

R8
STD – 21 x 10-1/2 x 2-3/8
True – 20 x 10 x 2
True F – 20 x 10 x 2-5/8

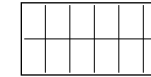

R12
True – 20 x 10 x 2-1/2
True F – 20 x 10 x 2-5/8

INJECTION MOLDED FLATS

- Flats provide outstanding strength and effective insert holding for automation efficiency
- Flats deliver increased flexibility and economy – constructed using quality, blended, recycled raw materials with additives
- All products are stretch wrapped on a pallet for secure shipping

Item #	Description	Length	Width	Height	Color	Tray Compatibility	Case Pk	Price (\$)
Standard Bedding Flats								
46105	1020 STD LTWT FLAT	21 1/8"	10 1/2"	2 1/2"	BK	D SERIES INSERTS(V), 03.50 SQ TRAD(I), DPS1801(V)	50	30.63
46106	1020 STD MDWT FLAT	21 1/8"	10 1/2"	2 1/2"	BK	D SERIES INSERTS(V), 03.50 SQ TRAD(I), DPS1801(V)	50	46.37
46104	1020 STD HVWT FLAT	21 1/8"	10 1/2"	2 1/2"	BK	D SERIES INSERTS(V), 08.50 SQ TRAD(I), DPS1801(V)	50	72.86
True Bedding Flats								
46107	1020 TRUE LTWT FLAT	20"	10"	2 1/2"	BK	T SERIES INSERTS(V), 05.50 SQ JUM TL TW(I), M-6 SQ TW(I), TPS1801(V)	50	30.56
46108	1020 TRUE MDWT FLAT	20"	10"	2 1/2"	BK	T SERIES INSERTS(V), 05.50 SQ JUM TL TW(I), M-6 SQ TW(I), TPS1801(V)	50	54.37
46117	T1020R61 TRUE FLAT, S	20"	10"	2"	BK	TJ606(V), T224HP(V), T412QP(V)	50	38.18

S=Seasonal Availability; BK=Black; HVWT=Heavyweight; LG-Long; LTWT=Lightweight; MDWT=Mediumweight; SH=Short; SJ=Slim Jim; SM=Skinny Minnie; ST=Super Thin; STD=Standard; T=True; TL=Tag Locator; (V)=Vacuum



Need a Helpful Hand?

See pages 2 & 3 for the listing of the Gloeckner Field Representatives – including yours!

Minimum order of 10 cases for all HC products.

HANGING BASKETS

- Multiple hanger styles for each grower's unique needs
- High-grade polypropylene and multiple cavity tooling
- Industry's broadest selection of shapes, styles, and sizes
- Available with external saucers to capture excess water
- Internal capillary dish creates a reservoir to promote longer plant life



Saucerless (SL)

Item #	Color	Item #	Color	Description	Inside Dia	Outside Dia	Height	Hanger Attachment	Case Pk	Price (\$)
ESL-Style										
46219	WH	46218	GN	08.00 ESL HB	7 7/16"	8"	5 9/16"		50	37.85
46197	WH	46196	GN	10.00 ESL HB 1	9 1/4"	10"	5 5/8"	OTR	50	40.83
46195	WH	46194	GN	10.00 ESL HB 2	9 1/16"	10"	6 1/8"	OTR/ITR	50	37.33
46207	WH	46206	GN	10.00 TUSCAN SL HB	9 1/16"	10"	5 3/4"	OTR/ITR	100	60.85
Euro Style										
46217	WH	46216	GN	06.00 EURO SL HB	5 7/8"	6 1/2"	4 1/4"		100	107.42
46221	WH	46220	GN	08.00 EURO SL HB 2	7 7/16"	8"	5 9/16"		50	41.76
46199	WH	46198	GN	10.00 EURO SL HB 2	9"	10"	6 1/8"	OTR/ITR	50	51.94
46191	WH	46190	GN	10.00 CASCADE SL HB	9 1/16"	10"	6 1/8"	OTR/ITR	100	103.88
47011	WH	47010	GN	12.00 EURO SL HB	11 1/16"	11 3/4"	7 1/4"		50	118.56
Traditional Style										
46205	WH	46204	GN	10.00 TRAD SL T HB	9 7/16"	10"	5 13/16"	OTR	50	47.46
46203	WH	46202	GN	10.00 TRAD SL HB	10"	10 3/4"	6 15/16"	OTR	50	47.18
46621	WH	46620	GN	10.00 TRAD SL MATTE HB	9 3/8"	10"	6 1/2"	OTR	50	38.76
46622	CEBN	N/A	N/A	10.00 MILANO SL HP	10"	6 3/4"			50	38.54
46213	WH	46212	GN	12.00 TRAD SL HB	10 29/32"	12"	7 7/8"	ITR	50	147.97
Color Basket Style										
46208	TC	46209	MO	12.00 COLOR SL BSKT	11 1/2"	12 3/16"	7 1/4"	OTR	25	69.26
46210	TC	46211	MO	12.00 CORDOVA SL HB W/DISH	12"	13"	8 1/2"	12.00 HOOP & HANGER	25	93.20
Roman Basket Style										
46200	TC	46201	MO	10.00 ROMAN SL HB	9 1/4"	10"	6 1/8"	OTR	50	40.68
Plug Pot										
46623	WH	46624	GN	10.00 SL PLUG POT 6 HOLES, S	9"	9 3/4"	5 5/8"	OTR	50	113.80
46625	WH	46626	GN	10.00 SL PLUG POT 12 HOLES, S	9"	9 3/4"	5 5/8"	OTR	50	102.54

With External Saucers (WS)

Item #	Color	Item #	Color	Description	Inside Dia	Outside Dia	Height	Hanger Attachment	Case Pk	Price (\$)
Traditional Style										
46233	WH	46232	GN	08.00 TRAD WS HB, S	7 7/16"	8 3/4"	5 1/16"	OTR	50	81.10
46225	WH	46224	GN	10.00 TRAD 2 WS HB	10"	10 3/4"	6 15/16"	OTR	50	92.05
46234	WH	45961	GN	SUPER TRAD WS HB	10 5/8"	11 5/8"	6 1/2"	OTR	50	117.49

S=Seasonal Availability; CEBN=Chocolate; GN=Green; HB=Hanging Basket; HP=Hanging Pot; ITR=In the Rim; M=Matte Finish; MO=Mocha; OTR=Over The Rim; SL=Saucerless; TC=Terra Cotta; TRAD=Traditional; TW=Thinwall; WH=White; WS=With Saucer
 Bulk Quantities at discounted prices available upon request.



Minimum order of 10 cases for all HC products.



EAST WIND HANGING BASKETS

Inspired by natural and robust textures, these durable containers are designed to complement the home from the inside out.

- Features high channels for flood floors
- Paint accentuates the engrained texture of the container
- Basket features chimney style drainage
- Made from durable polypropylene
- Premium finish includes high-quality, glossy finish

Item #	Mfr #	Part #	Description	Outside Dia	Height	Color	Case Pk	Price (\$)
Shimmer Series								
49891	YIH11000	YIH11005FB41025	11.00 HB	11"	6"	Sangria	25	39.91
49892	YIH11000	YIH11005G181025	11.00 HB	11"	6"	Black	25	39.91
49893	YIP07500	YIP07500Y84C025	7.50 Sq. Pltr	7.50"	7.62"	Sangria	25	33.14
49894	YIP07500	YIP07500Y97C025	7.50 Sq. Pltr	7.50"	7.62"	Black	25	33.14
49895	YIB07500	YIB12000Y84C025	12 Bowl	12"	4.88"	Sangria	25	43.23
49896	YIB12000	YIB12000Y97C025	12 Bowl	12"	4.88"	Black	25	43.23
IKAT Series								
49897	YKH11000	YKH11000Y076025	11.00 HB	11"	7"	BK/WH	25	71.96
49898	YKH11000	YKH11000Y806025	11.00 HB	11"	7"	Robin Blue	25	71.96
49899	YKH11000	YKH11000Y816025	11.00 HB	11"	7"	Bark	25	71.96
49900	YKS10000	YKS10000Y07C025	10.00 Pltr	10"	9"	BK/WH	25	70.56
49901	YKS10000	YKS10000Y80C025	10.00 Pltr	10"	9"	Robin Blue	25	70.56
49902	YKS10000	YKS10000Y81C025	10.00 Pltr	10"	9"	Bark	25	70.56
Bundled Thatch Series								
49903	YUH12000	YUB12000Y94C025	12.00 HB	12"	6.9"	Chocolate	25	42.67
49904	YUH12000	YUB12000Y95C025	12.00 HB	12"	6.9"	Taupe	25	53.31
49905	YUH12000	YUB12000Y96C025	12.00 HB	12"	6.9"	Dark Fawn	25	53.31
49906	YUH12000	YUB12000Y97C025	12.00 HB	12"	6.9"	Black	25	42.67
49907	YUB12000	YUB12000Y94C025	12.00 Bowl	12"	5.5"	Chocolate	25	42.67
49908	YUB12000	YUB12000Y95C025	12.00 Bowl	12"	5.5"	Taupe	25	55.31
49909	YUB12000	YUB12000Y96C025	12.00 Bowl	12"	5.5"	Dark Fawn	25	55.31
49910	YUB12000	YUB12000Y97C025	12.00 Bowl	12"	5.5"	Black	25	42.67
49911	YUP12000	YUP12000Y94C025	12.00 Pltr	12"	10"	Chocolate	25	72.77
49912	YUP12000	YUP12000Y95C025	12.00 Pltr	12"	10"	Taupe	25	78.48
49913	YUP12000	YUP12000Y96C025	12.00 Pltr	12"	10"	Robin Blue	25	78.48
49914	YUP12000	YUP12000Y97C025	12.00 Pltr	12"	10"	Black	25	72.77
Silhouette Collection								
49915	YHH12000	YHH12000Y856025	12.00 HB	12"	7"	Olive Green	25	88.83
49916	YHH12000	YHH12000Y866025	12.00 HB	12"	7"	Cabernet	25	88.83
49917	YHH12000	YHH12000Y936025	12.00 HB	12"	7"	Slate Grey	25	88.83
49918	YHB12000	YHB12000Y85C025	12.00 Bowl	12"	5.50"	Olive Green	25	58.58
49919	YHB12000	YHB12000Y86C025	12.00 Bowl	12"	5.50"	Cabernet	25	58.58
49920	YHB12000	YHB12000Y93C025	12.00 Bowl	12"	5.50"	Slate Grey	25	58.58
49921	YHP12000	YHP12000Y85C025	12.00 Pltr	12"	8.80"	Olive Green	25	80.99
49922	YHP12000	YHP12000Y86C025	12.00 Pltr	12"	8.80"	Cabernet	25	80.99
49923	YHP12000	YHP12000Y93C025	12.00 Pltr	12"	8.80"	Slate Grey	25	80.99
Pierced Bamboo								
49924	PBP12000	PBP11000P72C025	11.00 HB	12"	7"	Pierced Bamboo	25	93.39
49925	PBP12000	PBH12000P726025	12.00 Pltr	11"	12"	Pierced Bamboo	25	73.88
Wrapt HB								
49926	HWA11000	HWA11005G181025	11.00 HP	11"	6.55"	N/A	25	39.73
49927	HWA13000	HWA13000G181025	13.00 HP	11"	7.75"	N/A	25	66.39



Shimmer



IKAT

Bundled Thatch



Silhouette



Pierced Bamboo



Wrapt HB

Minimum order of 10 cases for all HC products.



ULTRA HANGING BASKETS

- Classic styling with a rough sandpaper-like texture
- Large soil volume for larger plants
- Inside divider with center drain reservoir
- Dual-drain system and wide, stable base
- Features TagGrip to securely hold plant identification

Item #	Description	Size	Color	Case Pk	Price (\$)
49952	11.0 Ultra Hanging Basket	11" OD x 6 1/2"H	Chocolate Brown	100	135.60
49953	11.0 Ultra Hanging Basket	11" OD x 6 1/2"H	Sandstone	100	135.60
49954	18.3 3-Strand Hanger	18"	Chocolate Brown	25	8.74
49955	18.3 3-Strand Hanger	18"	Sandstone	25	8.74
49956	12.0 Ultra Hanging Basket	12" OD x 7"H	Chocolate Brown	50	134.36
49957	12.0 Ultra Hanging Basket	12" OD x 7"H	Sandstone	50	125.59
49958	22.0 Long Strand Hanger	22"	Chocolate Brown	25	10.10
49959	22.0 Long Strand Hanger	22"	Sandstone	25	10.10
49045	11.5 Ultra Planter	11" OD x 8 1/2"H	Sea Struck	66	141.09
49046	11.5 Ultra Planter	11" OD x 8 1/2"H	Tequila Sunrise	66	141.09
49047	12.0 Ultra Planter	12" OD x 10"H	Sea Struck	50	148.41
49048	12.0 Ultra Planter	12" OD x 10"H	Tequila Sunrise	50	148.41
49049	12.0 Ultra Bowl	12" OD x 5 1/2"H	Sea Struck	100	257.21
49050	12.0 Ultra Bowl	12" OD x 5 1/2"H	Tequila Sunrise	100	257.21

The following additional color selections are available upon request: Boyz n Berry, Cool Mint Green, and Union Red.

RETRO HANGING BASKETS®

- Injection-molded polypropylene gives strength to progressive style
- Incredibly strong four-strand hanger holds up to 25 lbs
- Each order includes cap dish and matching color hanger

Item #	Description	Size	Color	Case Pk	Price (\$)
49051	12.0 Retro Hanging Basket	12" OD x 9 3/4"H	Black	50	156.28
49052	12.0 Retro Hanging Basket	12" OD x 9 3/4"H	Skylight Blue	50	156.28

The following additional color selections are available upon request: Moonstruck, Fawn, Steel Gray, and Tangerine.

Note: Price includes hanger & interior cap dish.

HANGERS

Item #	Color	Item #	Color	Hanger	Case Pk	Length	Basket Compatibility	Price (\$)
46185	WH	46184	GN	E-10 3-STRAND PLASTIC	50	16"	ALL 06.00 HB, 10.00 HB, 08.00 COLOR POT, 08.00 CORDOVA, 10.00 COLOR BOWL	12.75
46187	WH	46186	GN					
46627	CEBN	N/A	N/A	E-10 L (LONG) 3-STRAND PLASTIC	50	19 1/2"	ALL 08.00 HB, 10 HB, 08.00 SL HANGING POINT. POT, 10.00 SL HANGING POINT. POT, 10.00 COLOR BOWN, 08.00 COLOR POT, 08.00 CORDOVA, 10.00 CORDOVA	13.71
46628	TC	46629	MO					
46189	WH	46188	GN	E-12 4-STRAND PLASTIC	25	22"	ALL 12.00 HB, SUPER TRAD HB, 12.00 COLOR BOWL, 12.00 TRAD SL, 10.00 COLOR POT 1, 12.00 CORDOVA, 12.00 OVAL PLANTER, 16.00 OVAL PLANTER	12.22
46630	TC	46631	MO					
46181	WH	46180	GN	C-10 3-STRAND PLASTIC CLIP, S	50	16"	UP TO 07.50 TW POTS	14.42
46172	WIRE	N/A	N/A	12 HOOP & HANGER ASSEMBLY	25	19 3/4"	12.00 CORDOVA	137.24
46173	WIRE	N/A	N/A	14 HOOP & HANGER ASSEMBLY	22	25 1/2"	05.00 G SQUAT, 14.00 CORDOVA	126.08
46174	WIRE	N/A	N/A	17 3-STRAND METAL	50	17"	ALL 06.00 HB, 08.00 HB, 10.00 HB	13.37
46175	WIRE	N/A	N/A	21 3-STRAND FISH HOOK METAL	50	21 1/4"	10.00 TRAD SL, 10.00 TRAD WS, 10.00 EURO SL, 10.00 ESL 2	18.03
46176	WIRE	N/A	N/A	21 3-STRAND METAL	50	21"	ALL 08.00 HB, 10.00 HB	16.45
46177	WIRE	N/A	N/A	24 4-STRAND METAL	50	24"	12.00 TRAD SL HB, 12.00 EURO SL WS, SUPER TRAD WS H	21.43

S=Seasonal Availability; CEBN=Chocolate; GN=Green; HB=Hanging Basket; HP=Hanging Pot; ITR=In the Rim; M=Matte Finish; MO=Mocha; OTR=Over The Rim; SL=Saucerless; TC=Terra Cotta; TRAD=Traditional; TW=Thinwall; WH=White; WS=With Saucer

Bulk Quantities at discounted prices available upon request.

Minimum order of 10 cases for all HC products.

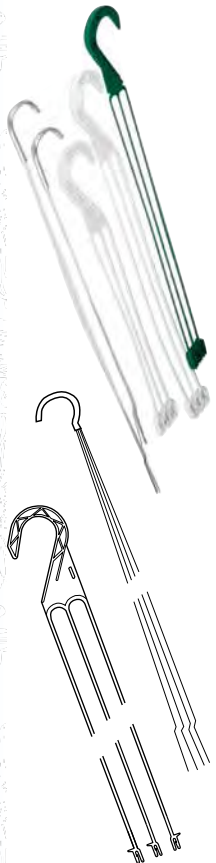

DECORATIVE COLOR PLANTERS

- Premium quality at competitive pricing
- Flexible, sturdy containers are perfect for patio, porch, or deck use
- Textured finish and molded-in design features create an elegant appearance
- Clay and Mocha color products are available in a matte finish



Item #	Color	Item #	Color	Description	Inside Dia	Out. Dia	Height	Hanger/Tray Compatibility	Case Pk	Price (\$)
Color Bowls										
46004	CL	46005	MO	10.00 COLOR BOWL	9 ¼"	9 15/16"	4 ¾"	HANGER E-10 OR E 10L	82	126.08
46018	CL	46019	MO	12.00 COLOR BOWL	12"	12 11/16"	5 3/16"	HANGER E-12	42	106.93
49034	CL	49033	MO	12.00 PANTERRA	N/A	12"	5 1/8"		50	94.45
46038	CL	46039	MO	14.00 COLOR BOWL, S	14"	14 ¾"	5 5/8"		45	142.09
46048	CL	46049	MO	16.00 COLOR BOWL	16"	16 7/8"	6 ¼"		25	117.77
Color Pots										
46059	CL	46060	MO	04.00 PANTERRA	N/A	4 ½"	3 ¾"		500	186.73
46071	CL	46072	MO	06.00 COLOR POT TL, S	6 3/16"	6 13/16"	5 ½"	SUNNYSIDE (I), 06.50 CARRYALL (I)	98	60.42
46079	CL	46080	MO	08.00 COLOR POT TL, P	8 ¼"	8 15/16"	6 1/16"	HANGER E-10 OR E-10L	58	82.16
49036	CL	49035	MO	08.00 PANTERRA	N/A	8 7/8"	6"		250	190.34
46006	CL	46007	MO	10.00 COLOR POT 1	10"	10 7/8"	7 ¾"	HANGER 3-12	58	107.36
46008	CL	46009	MO	10.00 COLOR POT 3 TL	9 1/16"	9 7/8"	7 7/8"		50	96.41
46022	CL	46023	MO	12.00 COLOR POT 1	12 13/32"	13 3/8"	9 ½"		28	69.80
46024	CL	46025	MO	12.00 COLOR POT 2 TL	10 15/16"	11 13/16"	9 ½"		40	93.51
46040	CL	46041	MO	14.00 COLOR POT	14 ¼"	15 17/32"	11 5/16"		20	101.99
Traditional Style										
46638	CEBN	46639	MO	10.00 MILANO PLTR	10.00	7 ¾"			50	104.21
Oval Color Planters										
46030	CL	46031	MO	12.00 OVAL COLOR PLTR	12 5/16"	12 31/32"	5"		88	188.18
46050	CL	46051	MO	16.00 OVAL COLOR PLTR	16 1/8"	16 15/16"	5 7/8"		43	132.76
46054	CL	46055	MO	20.00 OVAL COLOR PLTR, S	19 7/8"	20 7/8"	6"		28	99.73
Square Color Planters										
46084	CL	46085	MO	08.00 SQ COLOR PLTR	7 3/8"	8"	7 1/16"		56	115.77
46034	CL	46035	MO	12.00 SQ COLOR PLTR, S	9 ¾"	11 3/8"	10"		32	195.21
46046	CL	46047	MO	15.00 SQ COLOR PLTR, S	12 7/16"	14 3/8"	12 5/8"		10	114.21
Roman Urns										
46086	CL	46087	MO	09.00 ROMAN URN	8 1/8"	9"	7 1/8"		44	68.82
46036	CL	46037	MO	12.50 ROMAN URN, S	11 ¼"	12 ½"	9 7/8"		20	67.46
Deck Box										
46644	CL	46645	MO	24.00 UNIVERSAL DECK RAIL BOX	24"	12"	9"		5	73.64

P=Offset Printing Available; S=Seasonal Availability; BSKT=Basket; CEBN=Chocolate; CL=Clay; DP=Deep; HB=Hanging Basket; MO=Mocha; PLTR=Planter; SCR=Saucer; SL=Saucerless; TE=Taupe; TL=Tag Locator
 Bulk Quantities at discounted prices available upon request.

Minimum order of 10 cases for all HC products.

DECORATIVE COLOR PLANTERS – *continued*

Ultra Planters & Bowls

- The best features of the DecoStone and Centabella Planters
- Dual drain system for optimum drainage
- Designed to accommodate Drop-In Liners

Item #	Color	Item #	Color	Item #	Color	Description	Outside Dia	Height	Case Pk	Price (\$)
49928	Clay	49929	Sandstone	49930	Black	11.50 PLTR w/TagStrip	11"	8.5"	66	141.09
49931	Clay	49932	Sandstone	49933	Black	12.00 PLTR	12"	10"	50	148.41
49934	Clay	49935	Sandstone	49936	Black	12.00 BOWL	12"	5.5"	100	257.21

Additional standard colors Chocolate Brown and Taupe Fleck UV available upon request.



HANGING POTS AND ACCESSORIES

Ideal Alternative to Moss or Coco!

- Provide season long durability in moist and humid growing conditions
- WaxTough fortified and are an aesthetically pleasing, rich, dark, earth tone color
- 100% biodegradable and environmentally friendly
- Insulates roots from extreme variations in temperature
- “WaterSaver” feature is a reservoir that helps reduce watering cycles, assists with rehydration, and increases overall plant quality
- Manufactured from recycled materials

Pots and Pans

Item #	Description	Inside Dia	Outside Dia	Height	Comp. Hanger	Case Pk	Price (\$)
49937	08.00 w/G	8.50	7.50	6.00	HZP4LFG0, FHZSL4W0	24	51.55
49938	10.00 w/G	10.00	11.00	6.00	HZP4LFG0, FHZSL4W0	24	30.29
49939	10.00 XL, Pot Deep w/G	10.00	11.00	7.75	HZP4LFG0, FHZSL4W0	24	34.45
49940	12.00 w/G	11.63	12.50	7.00	HZP4LFG0, FHZSL4W0	12	40.01
49941	12.00 XL, Pot Deep w/G	12.00	13.00	9.00	HZP4LFG0, FHZSL4W0	12	45.66
49942	Hanger, 4-Strand Plastic	N/A	N/A	N/A	N/A	24	16.63
49943	Hanger, 4-Wire Long	N/A	N/A	N/A	N/A	24	12.52

Minimum order of 10 cases for all HC products.

Item #	Description	Inside Dia	Outside Dia	Height	Case Pk	Price (\$)
Square						
49944	4.00 Square Pot	3.50	4.25	3.50	400	68.80
49945	4.50 Square Pot	3.75	4.25	4.00	400	84.61
49946	5.00 Square Pot	4.75	5.50	3.50	250	65.41
Round						
49947	4.00 Standard Round Pot	3.50	4.00	3.50	500	57.96
49948	4.50 Geranium Pot	4.00	4.75	3.75	400	53.59
49949	5.00 Azalea Pot	5.00	5.50	3.75	250	54.24
49950	4.50 Standard Round Pot	3.75	5.00	3.75	250	43.39
49951	4.50 Azalea Pot	5.75	5.00	5.50	250	31.04



ROOT CONTROL BAG

Patented Aeration Container



High Caliper Growing System’s Root Control Bag is a truly, innovative, inexpensive, and practically foolproof way to grow potted (containerized) plants. The Root Control Bag is an aeration container, an improvement

in container technology that allows you to grow plants in a more favorable environment than in a similar sized, standard pot.

- Released heat
- Aerates the root zone
- Stops root circling
- Air-prunes the plant’s root structure
- Better than plastic containers, better than raised beds

Item #	Description	Size	Gallon	Color	Case Pk	Price (\$)
48862	Pro #1 (Hog Wire)	7" x 6"H	1	Black	900	1,057.50
48863	Pro #2	8" x 7"H	1.5	Black	600	765.00
48864	Pro #3	10" x 7.5"H	2.5	Black	400	685.00
48865	Pro #5	12" x 9.5"H	4.7	Black	250	534.50
48866	Pro #7	14" x 9.5"H	6.3	Black	200	532.50
48867	Pro #10	16" x 11.5"H	10	Black	150	543.75
48868	Pro #15	18" x 13.5"H	14.9	Black	75	360.00
48869	Pro #20	20" x 15.5"H	21.1	Black	75	424.75
48870	Pro #25	21" x 15.5"H	23.2	Black	60	392.25
48871	Pro #30	24" x 15.5"H	30.4	Black	60	425.25
48872	Pro #45	27" x 18"H	44.6	Black	50	517.00
48873	Pro #65	32" x 18"H	62.7	Black	50	545.00
48874	Pro #100	38" x 20"H	98.2	Black	35	543.50

Beige Smart Pots are available upon request.



STANDARD INSERTS

- T.O. Plastics inserts use a Z cut on the tear line; designed to be torn at retail without tearing the side of the next pack
- All Standard Inserts: 10.56" x 21.06" perimeter trim



T.O. PLASTICS



Item #	Mfr #	Description	Ind. Cell Dimensions			Case Pk	Price (\$)
			Width	Length	Depth		
200 Series							
45673*	715345C	201	10.13"	10.13"	2.30"	100	111.57
600 Series							
45674	715347C	601	4.88"	6.63"	2.33"	100	60.09
45675	715348C	606	1.94"	2.23"	2.23"	100	60.09
800 Series							
45677	715352C	801	4.86"	4.86"	2.27"	100	60.09
45678	715353C	804	2.40"	2.40"	2.23"	100	60.09
45679	715357C	806	1.50"	2.38"	2.25"	100	60.09
45680	715362C	809	1.50"	1.50"	2.28"	100	60.09
45681*	715364C	812	1.15"	1.59"	2.25"	100	64.64
1000 Series							
45682	715366C	1001	3.73"	4.80"	2.25"	100	60.09
45683	715367C	1004	2.35"	1.81"	2.24"	100	60.09
45684	715369C	1006	1.50"	1.77"	2.25"	100	60.09
1200 Series							
45685	715371C	1201	3.13"	4.88"	2.25"	100	60.09
45686	715373C	1202	3.10"	2.28"	2.27"	100	60.09
45687	715374C	1203	3.38"	1.50"	2.27"	100	60.09
45688	715377C	1204	1.50"	2.38"	2.26"	100	59.53
45689	715382C	1206	1.50"	1.50"	2.23"	100	60.09
47427	715420C	1206 – LC (low center)	1.38"	1.47"	2.38"	100	60.09
1800 Series							
45690	715385C	1801	3.11"	3.11"	2.25"	100	60.09
45691	715387C	1802	1.49"	3.11"	2.27"	100	60.09
45693	715389C	1803 (Tri-Pack)	2.25"	1.50"	2.30"	100	60.09
45694	715394C	1804	1.55"	1.55"	2.27"	100	60.09
2400 Series							
45695	715399C	2401	2.19"	3.06"	2.31"	100	60.09
3600 Series							
45696	715401C	3601	1.94"	2.23"	2.23"	100	60.09
Deep Inserts							
45697	715405C	606-DP	2.00"	2.25"	3.25"	100	61.39
48860	715408C	806-DP	1.56"	2.36"	3.13"	100	61.96

Available in an uncut version by special, custom order.

*Non-stock item, call for minimum quantity.

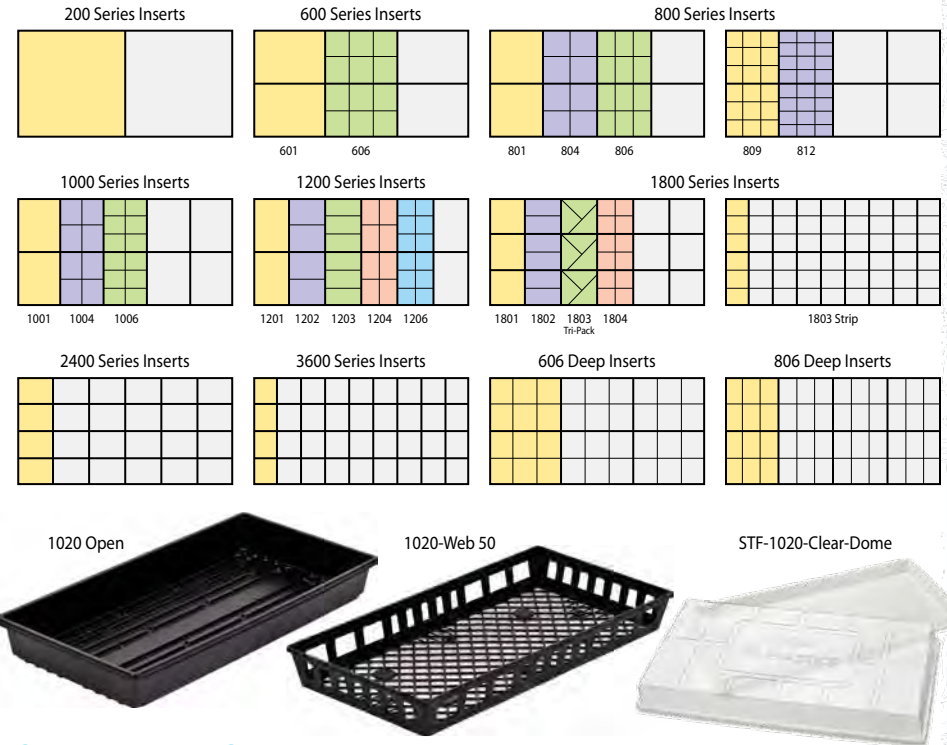

STANDARD FLATS

Item #	Mfr #	Description	Ind. Cell Dimensions			Case Pk	Price (\$)
			Width	Length	Depth		
45663	710245C	1020 open	10.94"	21.44"	2.44"	100	106.94
45664	710251C	1020 open, no holes	10.94"	21.44"	2.44"	100	106.94
47428	710260C	1020-R-6	10.94"	21.44"	2.44"	100	121.89
45667	710274C	1020-R-12	10.94"	21.44"	2.44"	100	130.57
45699	710280C	1020-R-18 tall post	10.81"	21.25"	2.56"	100	130.57
47429	790920C	1020-Web 50	10.75"	21.26"	2.40"	50	38.17

RETAIL MARKET PRODUCTS

Item #	Mfr #	Description	Dimensions			Case Pk	Price (\$)
			Width	Length	Depth		
45453	760549C	STF-1020-Clear-Dome	11.00"	21.50"	2.10"	50	108.81
45482	760746C	SOP-306-DP-WH-MP	10.56"	21.06"	3.54"	50	78.69
45602	745730C	Germ-Tray	10.81"	21.25"	1.29"	100	174.19
45601	745731C	Germ-Tray, no holes	10.81"	21.25"	1.29"	100	174.19

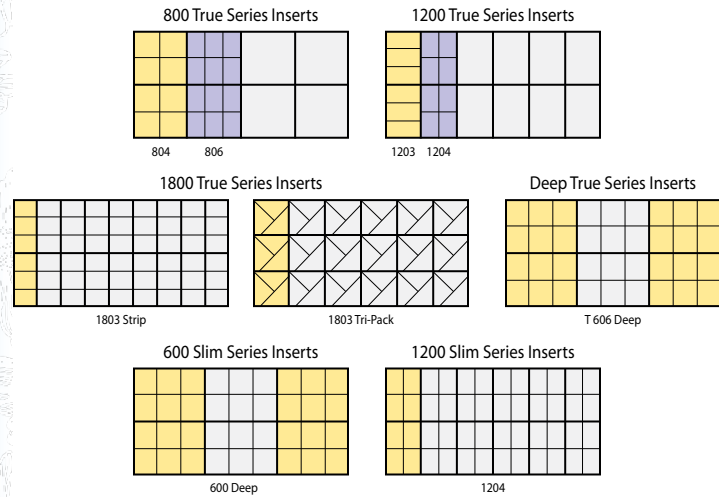

TRUE & SLIM INSERTS



True Series Inserts

- All True Inserts: 9.6875" x 19.6875" perimeter trim

Item #	Mfr #	Description	Individual Cell Dimensions			Case Pk	Price (\$)
			Width	Length	Depth		
45714	715323C	TRI-1203	1.42"	2.88"	2.63"	100	58.63
45715	715325C	TRI-1204	1.43"	2.22"	2.63"	100	56.70
45711	715335C	TRI-606-DP (Deep Inserts)	2.00"	2.12"	3.31"	100	58.63

Slim Series Inserts

- All Slim Inserts: 8.467" x 19.904" perimeter trim

Item #	Mfr #	Description	Individual Cell Dimensions			Case Pk	Price (\$)
			Width	Length	Depth		
45596	715316C	SLI-606-DP	1.87"	2.00"	3.25"	100	58.63
47430	715310C	SL-I-606-DP-CW – Community watering	1.87"	2.00"	3.25"	100	58.63
45597	715302C	SLI-1204	1.43"	1.75"	2.76"	100	58.63

TRUE & SLIM FLATS

True Series Flats

Item #	Mfr #	Description	Dimensions			Case Pk	Price (\$)
			Width	Length	Depth		
45706	710215C	TRF-1020-R-6	10.00"	20.00"	2.88"	100	108.81
45709	710222C	TRF-1020-R-12	10.00"	20.00"	2.88"	100	108.81
47433	710225C	TRF-1020-R-18	10.00"	20.00"	2.88"	100	108.81

Slim Series Flats

Item #	Mfr #	Description	Cell Dimensions			Case Pk	Price (\$)
			Width	Length	Depth		
45595	710203C	SLF-R-6	8.50"	19.93"	2.06"	100	108.81
45594	710208C	SLF-R-12	8.50"	19.93"	2.06"	100	108.81

PLANT PIE CONTAINERS

- Long shelf-life • Easy to grow • 100% reclaimed plastic, recyclable

Item #	Mfr #	Description	Dimensions		Case Pk	Price (\$)
			Diameter	Depth		
48644	790967C	Plant Pie-8	7.79"	3.04"	50	28.50
48643	790968C	Plant Pie-11	11.04"	3.03"	50	51.89

Item #	Mfr #	Description	Dimensions			Case Pk	Price (\$)
			Width	Length	Depth		
48642	790990C	Plant Loaf-11	5.88"	11.88"	3.04"	50	43.53
48645	790980C	Muffin Tray-4-8	10.94"	21.44"	3.04"	50	85.43

SQUARE POTS & CARRY TRAYS

- Durable, dependable and environmentally responsible – 100% recycled resins are extruded and formed into high-impact polystyrene pots and carry trays
- Press-Fill system saves both time and money
- Bulk volume pricing discounts available upon request



Vacuum Formed Square Pots

Item #	Mfr #	Description	Pot Dimensions			Case Pk	Price (\$)
			Top Outside	Bottom Outside	Depth		
45626	700003C	SVD-250 (4x8) (Uses #705105C Tray)	2.60"	1.65"	3.44"	800	51.73
47434*	700010C	SVD-250 (6x6) (Uses #705110C Tray)	2.60"	1.65"	3.44"	900	63.17
47435	700014C	SVD-325 (3x6) (Uses #705115C or 705119C Tray)	3.31"	2.50"	3.50"	450	43.11
45629	700022C	SVD-325 (4x5) (Uses #705125C Tray)	3.31"	2.50"	3.50"	900	89.81
45631	700026C	SVD-350 (3x6) (Uses #705130C or 710280C Tray)	3.52"	2.56"	3.50"	450	48.23
47436	700035C	SVD-355-NP (Uses #705137C Tray)	3.52"	2.56"	5.00"	450	74.63
47437	700074C	SVT-400 (3x5)* (Uses #705142C Tray)	3.66"	2.95"	3.11"	375	51.56
45646	700070C	SVT-400 (4x5)* (Uses #705144C or 705142C Tray)	3.66"	2.95"	3.11"	500	68.13
47438	700042C	SVD-450 (3x4)* (Uses #705155C Tray)	4.20"	3.42"	4.91"	300	53.43
45636	700051C	SVD-450 (3x5)* (Uses #705165C Tray)	4.20"	3.42"	4.91"	375	66.50
45637	700062C	SVD-450 (4x5)* (Uses #705150C Tray)	4.20"	3.42"	4.91"	500	89.57
45649	700076C	SVT-450 (3x4)* (Uses #705155C Tray)	4.20"	3.42"	3.62"	300	42.71
45650	700081C	SVT-450 (4x5)* (Uses #705150C Tray)	4.20"	3.42"	3.62"	500	70.49
45651	700087C	SVT-450 (3x5)* (Uses #705165C Tray)	4.20"	3.42"	3.62"	375	52.61
51926	700099C	NEW! SVD-550 (2x4) (Uses #705193C Tray)	5.36"	4.18"	15.24"	200	41.50

Standard color is black. Green and terra cotta available upon request – call for pricing.
Carton-pot stack configurations for Press-Fill applications.

Square Pot Carry Trays

Item #	Mfr #	Description	Trim Dimensions			Case Pk	Price (\$)
			Width	Length	Depth		
45606*	705100C	SPT-250-8-PF-MP* (Holds 8 - 250 Series Pots)	5.38"	10.61"	2.13"	400	212.34
45605	705105C	SPT-250-32-PF (Holds 32 - 250 Series Pots)	10.75"	21.19"	2.50"	100	125.79
47439*	705110C	SPT-250-36-PF (Holds 36 - 250 Series Pots)	16.75"	16.75"	2.30"	50	85.87
45609	705115C	SPT-325-12-PF (Holds 12 - 325 Series Pots)	6.75"	20.00"	1.88"	150	132.93
45610	705119C	SPT-325-18-PF (Holds 18 - 325 Series Pots)	10.00"	20.00"	1.88"	50	54.33
45611	705125C	SPT-325-20-PF (Holds 20 - 325 Series Pots)	13.50"	16.75"	1.88"	45	69.91
45613	705130C	SPT-350-18-PF (Holds 18 - 350 Series Pots)	10.81"	21.25"	1.93"	100	116.44
45621	705137C	SPT-355-18-DP (Holds 18 - 355 Series Pots)	10.81"	21.25"	3.50"	50	81.61
45615	705142C	SPT-400-15-PF (Holds 15 - 400 Series Pots)	11.25"	18.75"	1.94"	50	63.83
45616	705144C	SPT-400-20-PF (Holds 20 - 400 Series Pots)	15.00"	18.75"	1.88"	50	138.13
45617	705150C	SPT-450-10-PF (Holds 10 - 450 Series Pots)	8.75"	21.19"	2.13"	100	132.77
45619	705155C	SPT-450-12-PF (Holds 12 - 450 Series Pots)	12.88"	17.00"	2.13"	50	75.44
45618	705160C	SPT-450-12-HW (Holds 12 - 450 Series Pots)	12.88"	17.00"	3.19"	50	99.64
45620	705165C	SPT-450-15-PF (Holds 15 - 450 Series Pots)	12.88"	21.19"	2.13"	50	72.43
51927	705139C	NEW! SPT-550-8 (Holds 15 - 450 Series Pots)	10.94"	21.44"	3.03"	25	50.29
47441	795977C	Carry Handles, 23", White	1.00"	23.00"	-	150	25.56

Standard color is black. Custom colors available upon request.
Slotted for handles. Handles sold separately.

*Non-stock item, call for minimum quantity.



HOW TO USE T.O.P. – PRESS FILL TRAYS



SIMPLY PLACE, PRESS, AND LIFT A FULLY-LOADED TRAY OF POTS.

PLUG TRAYS



Standard Plug Trays

- All Standard Plug Trays: 11.0" x 21.22" perimeter trim



Standard 11.0" x 21.22"

Item #	Mfr #	Description	Trim Dimensions			Cell Dimensions		Case Pk	Price (\$)
			Cell Footprint	Drain Hole	Vent Hole	Depth	Top		
45511	720463C	PL-50	5 x 10	0.37"	0.25"	2.37"	1.90"	100	140.97
45513	720469C	PL-72	6 x 12	0.37"	0.25"	2.25"	1.52"	100	139.59
45516	720477C	PL-98	7 x 14	0.37"	0.25"	2.00"	1.34"	100	140.97
45519	720487C	PL-128	8 x 16	0.31"	0.18"	2.00"	1.19"	100	139.59
45520	720497C	PL-162	9 x 18	0.31"	N/A	1.75"	1.07"	100	140.97
45521	720507C	PL-200-1.5	10 x 20	0.25"	N/A	1.50"	0.86"	50	70.49
45522	720512C	PL-200-1.75	10 x 20	0.25"	N/A	1.75"	0.90"	50	70.49
45523	720520C	PL-200-2.125	10 x 20	0.25"	N/A	2.12"	0.97"	50	70.49
45524	720528C	PL-288-1.25	12 x 24	0.31"	N/A	1.25"	0.76"	50	70.49
47447	720532C	PL-288-1.5	12 x 24	0.31"	N/A	1.50"	0.76"	50	70.49
45525	720536C	PL-392	14 x 28	0.31"	0.15"	1.15"	0.70"	50	70.49
45526	720539C	PL-406	14 x 29	0.31"	N/A	1.15"	0.67"	50	70.49
45527	720544C	PL-512-CE*	16 x 32	0.31"	0.19"	0.94"	0.55"	50	75.36

Custom trim and weight options are available upon request. *Common Element.

T-Series Plug Trays

- All T-Series Plug Trays: 10.0" x 20.0" perimeter trim



T-Series 10.0" x 20.0"

Item #	Mfr #	Description	Trim Dimensions			Cell Dimensions		Case Pk	Price (\$)
			Cell Footprint	Drain Hole	Vent Hole	Depth	Top		
47448	720450C	PLT-72-RD	6 x 12	0.37"	0.50"	2.31"	1.50"	100	140.97
47449	720452C	PLT-84	7 x 12	0.37"	0.25"	1.50"	1.26"	50	75.84

Star & Hexagon Plug Trays

- All Star & Hexagon Plug Trays: 11.0" x 21.5" perimeter trim (unless otherwise noted)



Star 11.0" x 21.5"

Item #	Mfr #	Description	Trim Dimensions			Cell Dimensions		Case Pk	Price (\$)
			Cell Footprint	Drain Hole	Vent Hole	Depth	Top		
45508	720550C	PL-21-STAR-DP*	3 x 7	0.62"	0.50"	4.00"	2.72"	50	106.37
47450	720556C	PL-32-STAR-DP	4 x 8	0.62"	0.62"	4.00"	2.25"	50	114.26
45509	720557C	PL-36-STAR*	4 x 9	0.62"	0.50"	3.00"	2.12"	50	87.04
45510	720562C	PL-38-STAR-DP*	3 x 8, 2 x 7	0.75"	N/A	5.00"	2.13"	25	60.26
47451	720576C	PL-38-STAR-3.0*	3 x 8, 2 x 7	0.75"	N/A	3.00"	2.13"	50	82.10
47452	720578C	PL-38-STAR-4.0*	3 x 8, 2 x 7	0.75"	N/A	4.00"	2.13"	50	106.30
47453	720567C	PL-50-STAR	5 x 10	0.43"	0.25"	2.35"	1.77"	50	100.44
47454	720568C	PL-50-STAR-DP*	5 x 10	0.62"	0.50"	4.50"	1.94"	50	128.96
45512	720573C	PL-58-STAR	3 x 12, 2 x 11	0.38"	0.38"	2.38"	1.53"	100	140.97
45514	720575C	PL-72-STAR	6 x 12	0.37"	0.25"	2.25"	1.56"	100	139.59
45515	720580C	PL-72-STAR-DP*	6 x 12	0.43"	0.50"	3.00"	1.56"	50	87.04
45518	720585C	PL-105-STAR	7 x 15	0.37"	0.37"	1.50"	1.24"	100	140.97
45517	720589C	PL-105-HEX	7 x 15	0.37"	0.37"	1.50"	1.24"	100	140.97
47455	720547C	PL-512-HEX-CE**	16 x 32	0.31"	0.19"	0.94"	0.54"	50	81.04

*Perimeter trim size: 10.94" x 21.44". **Common Element.

Specialty Trays available upon request. Call for product and pricing information.





Made in USA

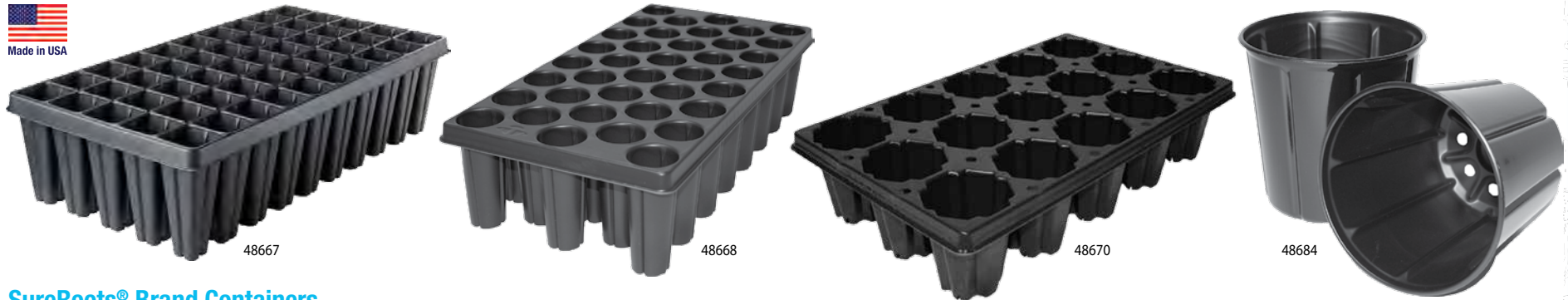

SureRoots® Brand Containers

- Ideal propagation tray for plants that require deep-rooted seedlings
- 100% reclaimed plastic/recyclable
- Heavy gauge

Item #	Mfr #	Description	Trim Dimensions		Cell Dimensions		Case Pk	Price (\$)
			Cell Footprint	Vent Hole	Depth	Top		
48667	720700C	PL-SR-50-DP-VH	5 x 10	0.25"	5.00"	2.00"	25	82.24
48668	720705C	PL-SR-38-DP-NV	3 x 8, 2 x 7	-	4.98"	1.95"	25	87.04
48670	720720C	PL-SR-15-VH	3 x 5	0.5"	4.59"	3.55"	25	43.53
48669	720715C	PL-SR-15-HW-NV	3 x 5	0.5"	4.59"	3.55"	25	87.04
51928	720723C	NEW! PL-SR-15-NV-POP BOTTOM	3 x 5	-	4.38"	3.55"	25	43.52

Item #	Mfr #	Description	Trim Dimensions			Case Pk	Price (\$)
			Width	Length	Depth		
48648	750900C	RP-SR-2QUART	6.00"	4.68"	5.80"	200	43.53

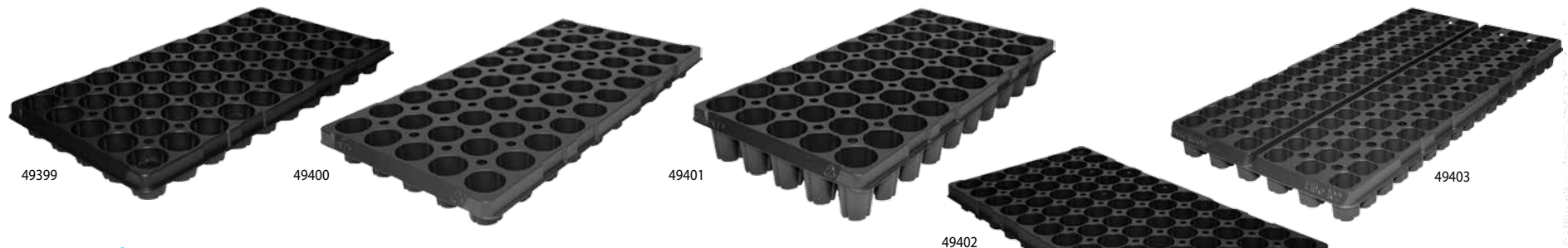

SureRoots® Elite Plug Trays **100% Recyclable!**

Designed with SureRoots cell technology, SureRoots® Elite Plug Trays support healthier and hardier roots and are ideal for growing a variety of plug types including: Elle plugs, paper plugs, synthetic plugs, soil plugs, glue plugs, peat, coir, pellets, and more.

- Cylinder shaped cells and V-shaped ribs from top-to-bottom prevents root wrapping
- De-stacking/de-nesting system for full automation
- Precise die cut drain holes allow for even drainage and consistent dislodging
- Made from reclaimed plastics – 100% recyclable after use

Item #	Mfr #	Description	Trim Dimensions			Case Pk	Price (\$)
			Width	Length	Depth		
49399	720750C	S-PL-SR-ELITE-50-1.75-40-VH	11.00"	21.50"	1.75"	50	61.63
49400	720753C	S-PL-SR-ELITE-50-1.75-35-VH	11.00"	21.50"	1.75"	50	61.63
49401	720760C	S-PL-SR-ELITE-50-3D-40-VH	11.00"	21.50"	3.00"	50	61.63
49402	720765C	S-PL-SR-ELITE-72-1.5-VH	11.00"	21.50"	1.58"	50	61.63
49403	720770C	S-PL-SR-ELITE-102-CUT-VH	11.00"	21.50"	1.62"	50	61.63
49404	720775C	S-PL-SR-ELITE-102-UNCUT-VH	11.00"	21.50"	1.62"	50	61.63
49405	720777C	S-PL-SR-ELITE-102-SPLIT-VH	11.00"	21.50"	1.62"	50	61.63

*Vent hole for all line items is 0.50.



45572



45576



45579

Round Pot Carry Trays

Item #	Mfr #	Description	Trim Dimensions			Case Pk	Price (\$)
			Width	Length	Depth		
45573	755802C	RPT-400-G-6-MP* (Holds 6 - 400 GV Series Pots ¹), White	8.00"	12.00"	3.59"	100	92.73
45571	755805C	RPT-400-G-10 (Holds 10 - 400 GV Series Pots)	8.21"	20.60"	3.75"	75	85.43
45572	755810C	RPT-400-G-15 (Holds 15 - 400 GV Series Pots)	12.31"	20.31"	3.81"	50	85.43
45574	755815C	RPT-425-G-10 (Holds 10 - 425 GV Series Pots)	8.63"	21.69"	4.03"	75	85.43
45575	755818C	RPT-425-G-12 (Holds 12 - 425 GV Series Pots)	13.00"	17.31"	4.03"	50	95.50
45576	755823C	RPT-425-G-15 (Holds 15 - 425 GV Series Pots)	13.00"	21.69"	3.75"	50	79.26
45577	755830C	RPT-450-G-10 (Holds 10 - 450 GV Series Pots)	9.19"	23.02"	4.05"	75	97.11
45578	755835C	RPT-450-G-12 (Holds 12 - 450 GV Series Pots)	13.81"	18.25"	4.00"	50	92.02
45579	755838C	RPT-450-G-15 (Holds 15 - 450 GV Series Pots)	13.80"	23.02"	4.05"	50	77.96
45580	755842C	RPT-500-AV-8 (Holds 8 - 500 AV Series Pots)	10.00"	20.00"	4.25"	50	66.99
45581	755845C	RPT-550-AV-6 (Holds 6 - 550 AV Series Pots)	13.50"	20.00"	5.12"	50	95.50
45585	755847C	RPT-TX-600-8 (Holds 8 - Texas AV 6" Pots)	11.00"	22.00"	4.85"	50	96.77
47442	775161C	RPT-TX-600-STAG (Holds 8 - Texas AV 6" Pots)	14.68"	17.87"	4.63"	50	98.99
47443	755848C	RPT-600-STD-6 (Holds 6 - Standard 6" Pots)	12.22"	18.19"	6.02"	50	84.61
45582	755850C	RPT-600-AV-6 (Holds 6 - 600 AV Series Pots)	12.25"	18.19"	4.94"	50	75.36
47444	775131C	RPT-600-AV-6-STAG (Holds 6 - 600 AV Series Pots)	11.19"	21.50"	4.85"	50	98.99
45583	755855C	RPT-650-AV-6 (Holds 6 - 650 AV Series Pots)	13.38"	19.94"	5.13"	50	95.50
45584	755859C	RPT-PRNL-6 (Holds 6 - Perennial Pots)	13.25"	20.25"	6.75"	50	95.50
47445	755864C	RPT-PRNL-3 (Holds 3 - Perennial Pots)	6.56"	20.13"	5.98"	100	98.83
48649	755900C	RPT-SR-2 Quart-8 (Holds 8-SR-2 Quart Pots)	12.66"	24.78"	6.03"	50	68.70

Standard color is black. Item indicated with an asterisk () is white. ¹Slotted for handles – sold separately.



A Message from David and Leighton Loop, Loop's Nursery, Jacksonville, FL

“ The potted plant industry is always growing, and our goal is to consistently deliver on quality, service, and innovation. As a family business, we strive to bring our family values to our operation every day, creating a dependable and friendly experience for both our employees and our customers. ”

The Fred C. Gloeckner Company extends its appreciation to David and Leighton of Loop's Nursery for taking time out of their busy day to be photographed for the cover of the 2018-2019 Gloeckner Greenhouse Grower Supplies Catalog, and more importantly, to the Loop's family for their loyal support and friendship since 1949!



Growing Systems, Inc.

GROWING TRAYS

- Manufactured from the highest quality resins with special modifiers added for greater durability
- Drainage holes are cleanly punched and are available in several diameters
- All Growing Trays measure 12" x 20"
- 100 trays per carton



Standard Growing Tray



Rose Pot Tray

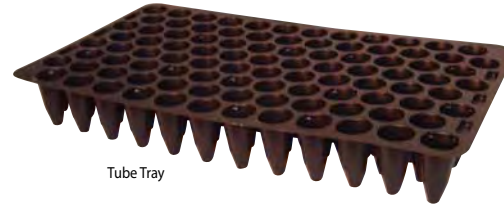

Tube Tray



Groove Tube Tray



Undertray



Sub-Irrigation Tray



1020 Plug Tray

Standard Growing Trays

- Polystyrene material, flexible usage • Can be re-used multiple times
- Champagne color trays are available with special order

Item #	Cells/Tray	Color	Diameter	Depth	Case Pk	Price (\$)
44301	18	Black	3"	2 3/4"	100	93.00
44269	24	Black	2 5/16"	2 3/4"	100	93.00
44275	33	Black	2 3/8"	2 1/2"	100	93.00
44277	38	Black	2 3/8"	2 1/2"	100	93.00
44281	51	Black	1 7/8"	2"	100	93.00
44283	73	Black	1 1/2"	1 3/4"	100	93.00
44285	96	Black	1 3/8"	1 1/2"	100	93.00
44299	135	Black	1 1/8"	1 1/2"	100	93.00
44300	170	Black	1 sq. in.	1 1/2"	100	93.00
44302	198	Black	7/8 sq. in.	1 1/2"	100	93.00
44271	273	Black	3/4"	1"	100	93.00
44273	273 sq.	Black	3/4 sq. in.	1"	100	93.00
44279	400	Black	5/8"	1"	100	93.00

Rose Pot Trays

- Square cells for large soil volume • Features large drainage holes

Item #	Cells/Tray	Color	Diameter	Depth	Case Pk	Price (\$)
44292	40 Round Bottom	Black	2 1/8 sq. in.	2 3/8"	100	93.00
44294	60 Flat Bottom	Black	1 3/4 sq. in.	2 3/4"	100	93.00
44295	60 Round Bottom	Black	1 3/4 sq. in.	2 3/4"	100	93.00

Tube Trays

- Deeper cells than standard trays • No bottom rim encourages air pruning

Item #	Cells/Tray	Color	Diameter	Depth	Case Pk	Price (\$)
44305	73	Black	1 1/2"	2 3/4"	100	93.00
44310	96	Black	1 3/8"	2 1/2"	100	93.00
44306	135	Black	1 1/8"	2 1/2"	100	93.00

Groove Tube Trays

- Sharp internal grooves extend the entire length of the cell wall to the very bottom of the tray to eliminate root circling prior to air pruning

Item #	Cells/Tray	Trays/Case	Color	Diameter	Depth	Thickness	Case Pk	Price (\$)
44262	38 Deep	50	Black	2 1/4"	3 1/2"	55 ga	100	105.00
44263	38 Deep	50	Black	2 1/4"	4 1/2"	55 ga	100	105.00
44264	38 Deep	50	Black	2 1/4"	5 1/4"	55 ga	100	105.00
44265	51 Deep	50	Black	1 7/8"	3 1/2"	30 ga	100	66.00
44266	73 Deep	100	Black	1 3/8"	2 3/4"	30 ga	100	93.00

Undertrays

- Improves tray handling and uniform water coverage • Five 3/8" drainage holes

Item #	Cells/Tray	Color	Diameter	Depth	Case Pk	Price (\$)
44313	Shallow	Black	11 1/8" x 19 1/4"	1"	100	103.00
44312	Deep	Black	11 1/8" x 19 1/4"	1 1/2"	100	103.00

Sub-Irrigation Trays

- Designed for use with plug trays to reduce plant stress in plugs by providing sub-irrigation
- No drainage holes

Item #	Cells/Tray	Color	Diameter	Depth	Case Pk	Price (\$)
44268	Shallow	Black	11 1/8" x 19 1/4"	1"	100	103.00
44267	Deep	Black	11 1/8" x 19 1/4"	1 1/2"	100	103.00

1020 Plug Trays

- Measures 11" x 21" • Dye-cut drainage holes allow for mechanical dislodging

Item #	Cells/Tray	Color	Diameter	Depth	Case Pk	Price (\$)
48131	200	Black	1 5/16 sq. in.	1 3/4"	100	103.00
48132	288	Black	3/4 sq. in.	1 1/2"	100	103.00



- For over 30 years, Topiary's production processes from sphagnum moss harvesting to handcrafting have been the most sustainable practices in the industry
- Our sphagnum moss products offer a complete one piece growing solution: no assembly needed
- As growers ourselves, we know what might work better for a commercial grower
- Every new product is tested in our greenhouses and outdoor growing conditions before introduced for sale

SPHAGNUM MOSS HANGING BASKETS

Topiary's hand made Sphagnum Moss Baskets will outlive any planter made from natural materials by years!



Item #	Size	Work Depth	Case Pk	Price (\$)
Standard Basket				
45878	10"	6"	30	5.90
45879	12"	6"	30	6.92
45880	14"	7"	22	8.95
45881	16"	8"	16	9.96
45882	18"	9"	12	12.49
45883	20"	10"	10	18.00
45884	22"	9"	7	24.00
45885	24"	9"	7	25.00
45886	26"	9"	4	34.00
45887	36"	9 1/2"	2	62.75
45888	48"	9 1/2"	1	84.00

Item #	Size	Work Depth	Case Pk	Price (\$)
Flat Bottom Basket				
45842	10"	6 1/2"	30	6.36
45844	12"	7"	26	7.96
45848	14"	7 1/2"	16	10.21
45852	16"	8 1/2"	12	11.65
45856	18"	10"	10	14.81

Item #	Size	Work Depth	Case Pk	Price (\$)
Super Deep Basket				
45846	12"	8"	22	9.45
45850	14"	9"	14	11.53
45854	16"	10"	10	13.82

Item #	Size	Work Depth	Case Pk	Price (\$)
Horn Shaped Basket with Chain Hanger				
47504	12"	15"	10	10.80
47505	14"	17"	10	13.40
47506	16"	19"	8	15.80
47507	18"	21"	5	19.50

All Topiary Art Works products sold in case lots only.

PLANTERS ON THE STEM & POLE BASKETS

Ideal for growing magical centerpieces for any season!

- Easy to assemble two-piece planter
- 38" high from top to bottom, 8" diameter ring stand/support
- Adjustable stabilizer for variety of pot sizes
- Bottom support has three holed flats for screw attachment inside wooden planters



Item #	Description	Dia	Case Pk	Price (\$)
45861	Sphagnum moss/wire planter	12"	10	18.50
45862	Sphagnum moss/wire planter	14"	10	21.60
47508	Coco fiber/wire planter	12"	10	16.90
47509	Coco fiber/wire planter	14"	10	19.60
47510	Wire only planter	12"	10	14.50
47511	Wire only planter	14"	10	15.50

SPHAGNUM MOSS BASKET WITH HANDLE

- Hand made sphagnum moss basket with handle built on durable, rigid wire form
- Sphagnum moss applied around the handle thick enough to sustain plant growth
- Sphagnum moss applied to the outside of the wire frame and fastened with monofilament



Item #	Size	Case Pk	Price (\$)
47512	10"	1	9.00
47513	12"	1	12.00
47514	14"	1	14.50
47515	16"	1	17.50
47516	18"	1	20.00

CONE BASKETS

- All planters ship complete, requiring no assembly
- Made to be reused for many growing seasons



Item #	Size	Work Depth	Case Pk	Price (\$)
Sphagnum Moss				
45843	12"	15"	20	9.85
45847	14"	17"	14	13.15
45851	16"	19"	10	15.50
45855	18"	21"	8	18.35
Iron Cone Basket Stand/Holder				
45830	12"		12	8.50
45831	14"		12	10.70
45832	16"		12	13.50
45833	18"		10	15.40

SPHAGNUM MOSS HANGING CRADLE PLANTER WITH CHAIN HANGER

Sturdy cradle planter is made from a thick layer of clean, high quality long fiber sphagnum moss that is hand applied to the outer surface of the metal cradle frame and fastened with monofilament.

- Heavy-duty galvanized wire frame measuring 12 1/2" width and 10" work depth inside
- Ample bottom surface is 6" wide
- Each planter comes with 11 gauge galvanized "jack" chain hanger

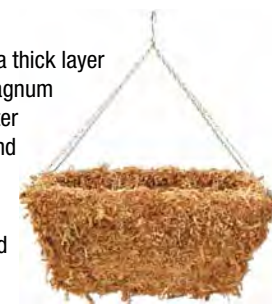

Item #	Size	Work Depth	Case Pk	Price (\$)
47502	24"	10"	4	29.75
47503	30"	10"	4	37.50

SPHAGNUM MOSS WINDOW BOX

Made from heavy gauge galvanized wire and covered with premium quality long fiber sphagnum moss.



Item #	Size	Work Depth	Width	Case Pk	Price (\$)
45858	24"	9"	8"	4	26.50
45859	36"	9"	8"	2	39.75

HANGING BALLS

Hanging Balls can be used with any plant material but are ideal for succulents.

- One piece construction fully filled with compressed long fiber sphagnum moss and ready for planting
- Frame is made from large gauge galvanized wire and spot welded for added durability



Item #	Size	Case Pk	Price (\$)
Sphagnum Moss Hanging Balls			
47496	3"	12	5.00
47497	4"	12	6.00
47498	6"	12	7.50
45877	8"	12	11.50
45874	10"	12	15.50
45875	12"	8	18.75
47499	14"	4	26.00
47500	16"	3	32.00
47501	18"	2	43.00
45876	20"	2	48.00
Moss Ball Topiary Trees with 12" Green Bamboo Stem			
47569	4"	12	8.00
47570	6"	12	9.50
Wire Hanging Balls			
47571	3"	12	3.50
47572	4"	12	3.75
47573	6"	12	5.65
47574	8"	12	7.50
47575	10"	12	9.50
47576	12"	8	11.25
47577	14"	4	13.10
47578	16"	3	15.00
47579	18"	2	16.95
47580	20"	2	18.10

WATERING CAN PLANTER

This colorful watering can features a detachable spout and handle for ease-of-use.

- Each order comes with 2 each of six attractive colors – yellow, green, blue, red, orange, and pink

Item #	Size	Case Pk	Price (\$)
48740	7"D	12 (6 colors)	4.51
48741	10"D	12 (6 colors)	6.44

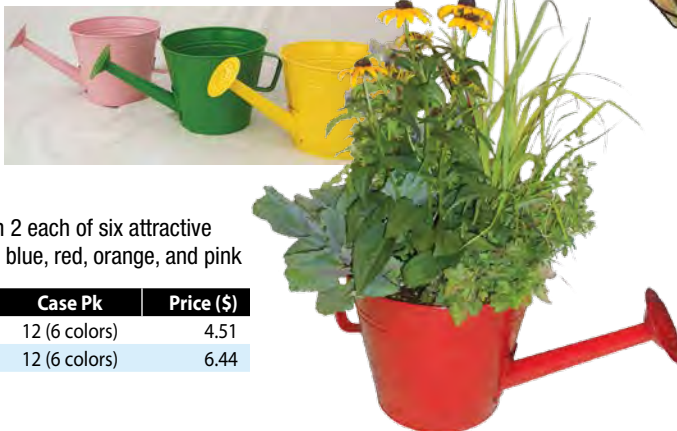

LIVING WREATHS



Item #	Size	Case Pk	Price (\$)	Item #	Size	Case Pk	Price (\$)	Item #	Size	Case Pk	Price (\$)
Sphagnum Moss Round Living Wreath Form w/Chain Hanger				Sphagnum Moss Square Living Wreath Form w/Chain Hanger				Sphagnum Moss Heart Shape Living Wreath Form w/Chain Hanger			
45873	9"	12	5.99	47456	9"	12	7.45	47464	9"	12	5.99
45867	11"	12	6.50	47457	11"	12	8.50	47465	11"	12	7.00
45866	13"	12	7.50	47458	13"	12	9.50	47466	13"	12	8.00
45868	15"	12	9.50	47459	15"	12	12.50	47467	15"	12	12.00
45869	17"	12	13.75	47460	17"	12	19.97	47468	17"	12	17.20
45870	19"	9	21.00	47461	19"	10	22.00	47469	21"	6	21.50
45871	21"	6	26.00	47462	21"	6	26.00	47470	25"	6	24.50
45872	24"	6	36.00	47463	24"	6	34.00				
Wire Round Living Wreath Form w/Chain Hanger (without Moss)				Wire Square Living Wreath Form w/Chain Hanger (without Moss)				Wire Heart Shape Living Wreath Form w/Chain Hanger (without Moss)			
47471	9"	12	3.90	47479	9"	12	4.57	47487	9"	12	4.15
47472	11"	12	4.80	47480	11"	12	5.67	47488	11"	12	5.19
47473	13"	12	5.81	47481	13"	12	7.40	47489	13"	12	6.10
47474	15"	12	7.66	47482	15"	12	8.20	47490	15"	12	7.80
47475	17"	12	9.26	47483	17"	12	9.85	47491	17"	12	9.20
47476	19"	12	9.50	47484	19"	12	11.00	47492	21"	6	11.00
47477	21"	6	11.60	47485	21"	6	13.60	47493	25"	6	13.75
47478	24"	6	13.60	47486	24"	6	16.50				

Sphagnum Moss Rectangular Living Wreaths				
47494	9" x 15"	12	10.50	
Wire Rectangular Living Wreaths				
47495	9" x 15"	12	6.00	

COMPRESSED SPHAGNUM MOSS LINER W/WIRE BASKET

Featuring an innovative liner that has been years in the making, this is an ideal choice for the professional grower who prefers an all-natural way of growing.

- Traditional rigid powder coated metal basket hugs perfectly compressed sphagnum moss growing layer
- Double the volume of sphagnum moss in each insert
- Sphagnum moss stays tightly formatted when in use allowing for greater moisture retention

Item #	Size	Work Depth	Case Pk	Price (\$)
48707	12"	5"	15	7.00
48708	14"	7"	15	9.00
48709	16"	8"	15	10.95
48710	18"	9"	10	15.20

Please specify plain rigid wire or wire/chain when ordering.





HANGING BASKETS WITH COCO LINER

Item #	Size	Work Depth	Case Pk	Price (\$)
Standard Shape Painted Green Wire Basket w/Wire Hanger & Liner				
47560	12"	6 1/2"	24	4.26
47561	14"	6 1/2"	24	4.53
47562	16"	7 1/2"	24	5.72
47563	18"	8"	12	7.76
47564	20"	9 1/2"	12	9.28
47565	24"	9 1/2"	12	12.55
Square Top Cone Shaped Hanging Basket w/Wire Hanger & Liner (Dark Green)				
47566	14"	15 1/2"	12	9.20
Round Top Cone Extra Heavy Duty Body Hanging Basket w/Wire Hanger (Dark Green)				
47567	14"	15 1/2"	12	8.30
Queen Elizabeth Parasol Hanging Basket w/Chain Hanger & Aged Iron Color Finish				
47568	14"	12"	6	17.50

WILLOW HANGING BASKETS

New Large Flat Bottoms!

Item #	Size	Work Depth	Flat Bottom Dia	Case Pk	Price (\$)
Dark Willow Branch Hanging Basket w/Liner and Wire Hanger					
47530	12"	5 1/4"	6"	20	4.97
47531	14"	6"	7"	20	6.36
47532	16"	6"	9"	20	7.65
Dark Willow Branch Cone Shape Hanging Basket w/Liner and Wire Hanger					
47533	12"	13 1/2"	20	16	7.34
47534	14"	14"	20	10	9.50
47535	16"	16"	20	8	13.90
47536	18"	18"	20	6	15.00

HANGING PLANTERS & TREE

Item #	Size	Depth	Color	Case Pk	Price (\$)
Pro Grow Hanging Planter w/Wire Hanger					
47517	12"	6 1/2"	Green	25	4.03
47518	14"	7"	Green	25	4.74
47519	16"	7 3/4"	Green	25	5.84
47520	18"	8 1/2"	Green	15	7.92
47521	20"	9 3/4"	Green	15	10.30
Pro Grow-Plus Hanging Planter w/Chain Hanger					
47522	12"	5 1/2"	Black	10	6.45
47523	14"	6 1/4"	Black	10	8.57
47524	16"	6 3/4"	Black	10	11.05
47525	18"	7 1/2"	Black	10	13.27
47526	20"	9"	Black	5	16.86
47527	24"	9 1/2"	Black	5	22.53
4-Arm Hanging Planter Tree					
47528	30" x 66 1/2"		Antique White	1	29.50
47529	30" x 66 1/2"		Black	1	29.50



"S" HOOKS – EXTENSION HANGERS

- USA made 10 gauge (0.10189") galvanized wire
- Extension hooks are rated up to 50 lbs weight
- Mix and match S-Hook quantities (in 100 pieces lots)
- 6" to 60" lengths



Item #	Length	Price (\$)	Item #	Length	Price (\$)
47537	6"	.19	47543	30"	.56
47538	12"	.28	47544	36"	.64
47539	15"	.32	47545	42"	.72
47540	18"	.37	47546	48"	.80
47541	20"	.42	47547	54"	.88
47542	24"	.49	47548	60"	.99

9 and 6 gauge wire available upon request.

TOPIARY GALVANIZED WIRE HANGING BASKETS

- Baskets are made from durable galvanized steel wire and come unpainted
- 10", 12", 14" and 16" wire baskets come with galvanized 3-strand wire hanger
- 18", 20", 22", 24" and 26" hangers come with a green, 4-strand wire hanger
- 36" and 48" wire baskets come with heavy-duty galvanized steel 6-strand chain hangers



Item #	Size w/Chain Hanger	Case Pk	Price (\$)
47549	10"	25	3.62
47550	12"	25	4.10
47551	14"	25	4.50
47552	16"	25	4.90
47553	18"	25	5.60
47554	20"	25	8.40
47555	22"	25	13.25
47556	24"	25	14.00
47557	26"	25	14.33
47558	36"	4	36.60
47559	48"	4	48.00

Please select from the following at **no extra charge**:

- Hanger #1: Galvanized heavy-duty 14 gauge wire hanger with straight up twisted "neck."
- Hanger #2: Galvanized heavy-duty 16 gauge wire hanger with spun around the hook wire.
- Hanger #3: Galvanized heavy-duty 14 gauge wire hanger with "loose" S-hook.



21" HD Hanger



BASKET BUDDYS UFO (Unique Flowering Object) BASKETS

- Features planting holes around the outside so starts can immediately begin trailing down the sides of your basket
- Watering can be decreased due to a reservoir at the bottom, trapping any results of overwatering for future use by the plants.
- Assembles in a snap

Item #	Description	Case Pk	Price (\$)
Traditional UFO			
44433	12"D, (6) 2" watering holes	48	228.00
Mini-UFO			
44434	8"D, (4) 2 ¼" watering holes	40	83.75
Maxi-UFO			
44435	14"D, (6) 2 ¼" watering holes	12	64.25
Heavy-Duty Wire Hanger			
48958	21", 3 Strand	500	126.75



3-Wire Hanger
Included With All
Basket Buddies
Orders



BASKET BUDDYS HANGING FLOWER TOWERS

- 2' Flower Tower can be accessorized with up to three 1' Flower Tower Extensions making an impressive full 5' tower of blooms
- No assembly required
- Features a water receptacle that fits into the top of the container directing the water down through the center of the media, making watering a snap

Item #	Description	Case Pk	Price (\$)
Hanging Flower Tower			
44431	14"H, (8) 1 ½" watering holes	18	88.25
Hanging Flower Tower w/Deck Ring			
44429	2'H, (16) 1 ½" watering holes, 12 ½"D base	12	70.75
1 Ft Flower Tower Extension			
44430	1'H, (8) 1 ½" watering holes	12	38.00



ECKERT'S GREENHOUSE "THE WEEKENDER" 16" HANGING BASKET

- 16" outside diameter, 14.5 inside diameter
- 30-40 lbs in weight (soil, water, and plants)
- Removable liner insert: .125" thick polypropylene, holds 745.20 cu. inches of soil, 6.3" deep
- 1 gallon water reservoir
- Year round usage, withstands heat to 220° and cold to 40° below

Item #	Color/Description	Price (\$)/ea
46522	Black	18.15
46523	White	18.15
49683	Forest Green	18.15
46524	Sea-Foam Green	18.15
46525	Terracott	18.15
46526	Sand	18.15
46527	Extra Liner, ea.	7.50
49684	Extra Plug, ea.	1.00
49685	Extra Wicking/set	.75

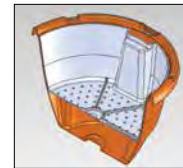

Please specify from the following hanger options:
Swivel – for high wind areas; Twisted – decorative option.

ECKERT'S GREENHOUSE H₂O LABOR SAVER 23" HANGING BASKET

- 23" outside diameter; made of .250 HMWPE
- 60-75 lbs in weight (soil, water, and plants)
- 2.46 gallon water reservoir
- Removable liner insert: .150" thick HMEPE, holds 1,645 cu. inches of soil
- Year round usage, withstands heat to 220° and cold to 40° below

Item #	Color/Description	Price (\$)/ea
46528	Black	66.25
46533	Extra Liner, ea.	21.00
49686	Extra Plug, ea.	1.75
49687	Extra Wicking/set	1.00

Please specify from the following two hanger options: Chrome chain – holds 400 lbs. test load; Four strand heavy-duty swivel hanger – holds 250 lbs.

ECKERT'S GREENHOUSE 28" WRAP AROUND BASKET

- 100-120 lbs. per pole (50-60 lbs. per side)
- 2.2 gallon reservoir
- Mounting bracket – stainless steel or black option
- Removable liner insert: .150" thick polypropylene, holds 1478.40 cu. inches of soil, 9' deep
- Wicking detail: feet spin to lock (4.5")



Item #	Color/Description	Price (\$)/ea
49688	Black, adj. mount included	175.00
49689	Extra liners per side, ea.	18.40

Please specify steel or black bracket.

ECKERT'S GREENHOUSE IRON HANGER AND ACCESSORIES

- Make your surroundings more colorful and inviting with Eckert's interchangeable iron display
- Customize to every need

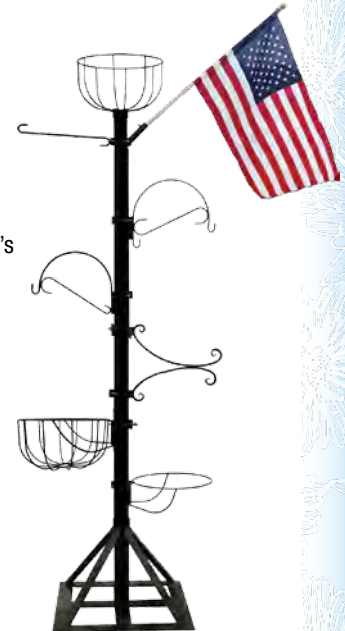

Item #	Description	Price (\$)/ea
49201	3' base	178.00
49202	8' stem	88.00
49203	10' stem	108.00

Accessories		
49191	16" Hoop Bracket	45.00
49197	Flat Iron Scroll Bracket	62.50
49196	Round Iron Scroll Bracket	53.25
49691	16" Onion w/Coco Bracket	61.00
49198	16" Topper	47.50
49200	Banner Arm	25.00
49690	Flag Holder	31.25

Ask about the many additional available accessories.



Basket Hangers Included at No Extra Charge With Most Basket Orders!*

Since 1972, Belden Plastics has developed a well earned following with the growers for their elegant, quality made baskets and support products.

- Belden products are comprised of high-quality 100% post industrial recycled raw material with the exception of the Pop and Hanging Garden Baskets, and are completely PP5 recyclable (Garden is PS6 recyclable)
- Belden 8" and 10" Hanging Baskets are priced to include a wire or plastic hanger of your choice
- Baskets are quality made with reinforced, heavy plastic and feature a unique locking system to lock in hangers
- Hangers are galvanized steel or color matched plastic

Note: All measurements are inside dimensions.

HANGING BASKETS

All Orders Include a Wire or Plastic Hanger in the Base Price!

- Sleek contemporary design inspires creative presentations
- Heavy-duty, long-lasting basket is made with recycled products
- Great water reservoir means no daily watering
- Includes removable outside saucer (saucerless baskets includes internal wicking saucer)



Item #	Color	Dimensions	Capacity	Case Pk	Price (\$)
6" Basket w/Plastic Hanger					
43545	Green	6"W x 4 1/4"D	49 fl oz	50	41.73
43547	White	6"W x 4 1/4"D	49 fl oz	50	41.73
8" Basket w/Wire Hanger					
43548	Green	8"W x 5"D	108 fl oz	50	58.52
43639	White	8"W x 5"D	108 fl oz	50	58.52
8" Basket w/Plastic Hanger (includes removable outside saucer)					
43636	Green	8"W x 5"D	108 fl oz	50	58.52
43638	White	8"W x 5"D	108 fl oz	50	58.52
10" Contemporary w/Wire Hanger					
43646	Green	10"W x 5 3/4"D	1.4 gal	50	60.41
43651	White	10"W x 5 3/4"D	1.4 gal	50	60.41
47905	Black	10"W x 5 3/4"D	1.4 gal	50	60.41
43649	Terra Cotta	10"W x 5 3/4"D	1.4 gal	50	60.41
10" Contemporary w/Plastic Hanger					
43647	Green	10"W x 5 3/4"D	1.4 gal	50	60.41
43650	White	10"W x 5 3/4"D	1.4 gal	50	60.41
47906	Black	10"W x 5 3/4"D	1.4 gal	50	60.41
43648	Terra Cotta	10"W x 5 3/4"D	1.4 gal	50	60.41
10" Classic w/Wire Hanger					
43641	Green	10"W x 5 3/4"D	1.32 gal	50	60.41
43644	White	10"W x 5 3/4"D	1.32 gal	50	60.41

Item #	Color	Dimensions	Capacity	Case Pk	Price (\$)
10" Classic w/Plastic Hanger					
43640	Green	10"W x 5 3/4"D	1.32 gal	50	60.50
43643	White	10"W x 5 3/4"D	1.32 gal	50	60.50
10" Saucerless Basket w/3-Strand Wire Hanger					
43671	Green	9 1/2"W x 5 3/4"D	1.24 gal	50	65.13
43673	White	9 1/2"W x 5 3/4"D	1.24 gal	50	65.13
47907	Black	9 1/2"W x 5 3/4"D	1.24 gal	50	65.13
Best Seller - 12" Saucerless Basket w/4-Strand Wire Hanger					
43674	Green	11 3/4"W x 7"D	2.28 gal	25	74.51
43676	White	11 3/4"W x 7"D	2.28 gal	25	74.51
47908	Black	11 3/4"W x 7"D	2.28 gal	25	74.51
43675	Terra Cotta	11 3/4"W x 7"D	2.28 gal	25	74.51
49856	Mocha	11 3/4"W x 7"D	2.28 gal	25	74.51
Best Seller - *14" Saucerless Basket w/4-Strand Powder Coated Matching Hanger					
43677	Green	14"W x 8 1/4"D	3.96 gal	25	127.50
43679	White	14"W x 8 1/4"D	3.96 gal	25	127.50
47909	Black	14"W x 8 1/4"D	3.96 gal	25	127.50
43678	Terra Cotta	14"W x 8 1/4"D	3.96 gal	25	127.50

*Belden's 14" basket comes complete with a 26" long powder coated hanger to match the basket color.

HANGING GARDEN™ BASKETS



- Includes wire hanger
- Makes for a unique basket with different plants and colors on top and the sides
- Ideal for use as an herb garden
- Basket is completely covered when in full bloom
- Features 360° of color

Item #	Color	Dimensions	Capacity	Case Pk	Price (\$)
8" Basket w/Wire Hanger					
43562	Green	7 5/8"W x 5"D	84.5 fl oz	50	126.75
10" Basket w/Wire Hanger					
43560	Green	10"W x 5 1/2"D	1.21 gal	25	104.00
43561	White	10"W x 5 1/2"D	1.21 gal	25	104.00

FLOWER BOXES

Grow or sell from these handy new pots that conveniently fit four to a 1020 flat.



Item #	Color	Size (ID)	Capacity	Case Pk	Price (\$)
Textured					
48884	Black	5"D x 10"L x 5"H	.92 gal	50	61.07
48885	Green	5"D x 10"L x 5"H	.92 gal	50	61.07
48886	Terra Cotta	5"D x 10"L x 5"H	.92 gal	50	61.07
48887	Mocha	5"D x 10"L x 5"H	.92 gal	50	61.07

FLEXIBLE HANGER

- Provides 50% faster installation
- Extra strong and flexible
- Always hangs even
- Easy-to-use, no more bending wires



Item #	Size	Bundle Pk	Price (\$)
48888	19", 3-wire	25	12.75
48889	22", 4-wire	25	22.30



SQUARE POTS

- Bi-level drainage holes allow the containers to drain consistently ensuring healthier root and plant development
- Comprised of the highest quality 100% post industrial recycled raw materials
- Most feature a tag lock system to secure plant tags during production to ensure information is readily available for retailers and customers

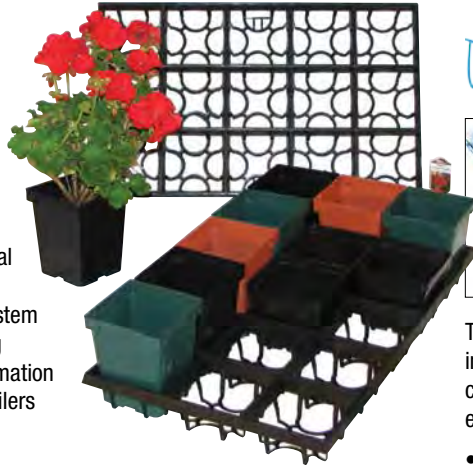

4.5 Square*

Ideal for most spring flowering annuals such as geraniums and gerbera daisies. Compatible with the 4515 Web Fit Tray.

Item #	Color	Dimensions	Capacity	Case Pk	Price (\$)
43591	Green	4 1/8"W x 3 1/2"D	25.3 fl oz	450	85.87
43590	Black	4 1/8"W x 3 1/2"D	25.3 fl oz	450	76.04
43592	Terra Cotta	4 1/8"W x 3 1/2"D	25.3 fl oz	450	85.87

*Does not have tag lock feature.

Jumbo Junior

Extra deep growing container for increased sales volume and better root development. Compatible with the 4515 Web Fit Tray.

Item #	Color	Dimensions	Capacity	Case Pk	Price (\$)
43583	Green	4 1/8"W x 5"D	35.1 fl oz	375	75.51
43582	Black	4 1/8"W x 5"D	35.1 fl oz	375	67.73
43584	Terra Cotta	4 1/8"W x 5"D	35.1 fl oz	375	75.51

Maxi Square

Compatible with the lightweight and heavyweight 1020 Web Flats.

Item #	Color	Dimensions	Capacity	Case Pk	Price (\$)
43571	Green	3 1/2"W x 3 1/2"D	16 fl oz	540	72.21
43570	Black	3 1/2"W x 3 1/2"D	16 fl oz	540	66.67
43572	Terra Cotta	3 1/2"W x 3 1/2"D	16 fl oz	540	72.21

Jumbo Square

Twice the volume as a traditional quart container. Features a wide base, easy-to-grip rim and sturdy build.

Item #	Color	Dimensions	Capacity	Case Pk	Price (\$)
43580	Green	5 1/4"W x 5 1/4"D	56.8 fl oz	200	71.83
43579	Black	5 1/4"W x 5 1/4"D	56.8 fl oz	200	63.49
43581	Terra Cotta	5 1/4"W x 5 1/4"D	56.8 fl oz	200	71.83



THIRST Quencher



The Thirst Quencher Watering Pipe makes watering Al's Flowering Pouch as easy as 1, 2, 3! And more importantly, it creates a channel that allows water to "wick" to the bottom of the pouch, ensuring healthier plants.

- Speeds up watering time
- Works with large pots
- Reusable design saves money

Item #	Description	Case Pk	Price (\$)
51690	Unit (1.575" x 1.575" x 10.24")	48	.73/ea
51691	Unit (1.575" x 1.575" x 10.24")	500	.56/ea



AZALEA POTS



Item #	Color	Dimensions	Case Pk	Price (\$)
43525	Black	5"W x 3 3/4"D	400	55.68
43531	Black	6"W x 4 1/2"D	300	58.28
43528	Black	6 1/2"W x 4 3/4"D	300	63.73
43537	Black	7"W x 5 1/4"D	200	80.87
43534	Black	7 1/2"W x 5 5/8"D	200	82.40
43542	Black	8"W x 6"D	100	53.81
43539	Black	8 1/2"W x 6 1/2"D	100	58.40
43515	Black	10"W x 7 1/2"D	40	47.73
43518	Black	12"W x 9"D	25	54.40



6" STANDARD LILY POT



Item #	Color	Dimensions	Case Pk	Price (\$)
43615	Black	6"W x 6"D	300	73.83

Azalea & Lily Pots also available in Green & Terra Cotta colors. Call for prices.



Al's Flower POUCH the original



- Pre-cut slits saves time for the grower and are spaced to maximize coverage
- Side slits allow ease of shipping as well as easily transportable for your customers
- Patented fused double handle increases strength to over 11 mil.

Original 10-Slit (8 1/2"W x 20"L)

Most popular size • Saves time for the grower • Allows for great coverage

Item #	Description	Case Pk	Price (\$)
43000	Unit	100	.73/ea
	Unit	250	.62/ea

5-Slit (8 1/2"W x 20"L)

Designed for larger or premium plugs (Eg. New Guinea Impatiens, Ivy Geraniums, Wave Petunias, etc.)

Item #	Description	Case Pk	Price (\$)
43001	Unit	100	.73/ea
	Unit	250	.62/ea

Mini-Pouch (8 1/2"W x 13"L)

Ideal for Western growers who use 15" shipping carts • Ideal for use as herb gardens, vegetable gardens, premium annuals, strawberries, etc.

Item #	Description	Case Pk	Price (\$)
43002	Unit	100	.70/ea
	Unit	250	.60/ea



JIFFYPOT® The Original 100% Compostable Peat Pot!

The Jiffypot is the environmental friendly

alternative to the use of plastic in horticulture. Jiffy Peat Pots are 100% compostable.

- Jiffypots are well suited for mechanical handling – *reducing labor costs*
- *Quicker rooting* is achieved as a result of reduced temperature fluctuations in the root zone
- Jiffypot's ability to retain moisture in the pot wall *can reduce water consumption* up to 20%, compared to plastic
- Jiffypot is an OMRI listed product line and Certified Home Compostable (Vincotte)



Item #	Mfr #	Drain/Type	Size	Case Pk	Price (\$)
Pots					
44520	70000357	SL	2" x 2" round	3564	123.93
44524	70000504	WH	2" x 2" square	3500	119.71
44521	70000494	WH	2 ¼" x 2 ¼" round	2816	81.67
44525	70000505	WH	2 ¼" x 2 ¼" square	2560	97.85
44515	70000502	WH	2 ¾" x 3 ½" round	1372	74.84
44522	70000503	WH	3" x 3" round	1404	71.57
44526	70000362	WH	3" x 3" square	1260	99.53
44516	70000679	WH	3" x 4 ½" round	1080	66.45
44527	70000461	SL	3 ½" x 4" square	800	66.76
44523	70000293	WH	4" x 3 ¾" round	1100	107.12
44528	70000871	WH	4 ½" x 4" round	960	125.20
44519	70000604	WH	4 ½" x 5 ½" round	896	166.79
44517	70000749	WH	5" x 4" round	600	101.55
Poly-Pak (Pre-Loaded)					
44556	70000528	SL	2" x 2" round, 36 cavity, 119 pot	1872	94.97
44553	70000504	WH	2" x 2" square, 50 cavity, 218 pot	2300	119.71
44563	70000468	WH	2" x 3" square, 50 cavity	2000	107.79
44558	70000507	WH	3 ½" x 4" square, 18 cavity, 240 pot	558	77.79
44561	70000517	WH	1 ¼" x 2", 98 cavity, strip	5096	133.92
44562	70000536	WH	2 ½" x 3", 32 cavity, strip	1344	91.37
44560	70000908	NH	2 ½" x 6", 32 cavity, strip	896	91.10
44557	70000512	SL	3" x 3", 18 cavity, strip	792	92.28
44555	70000724	WH	4" x 3 ½" square, 16 cavity, 249 pot	304	80.84
44565	70000463	WH	2" x 3" square, 81 cavity	1620	80.90
44564	70000478	WH	2 ½" x 3", 49 cavity, strip	980	82.93
Strips					
44566	70000428	WH	1 ¼" x 2 ½", 12 pots/624 case	7488	163.39
44569	70000511	WH	1 ½" x 3 ½", 12 pots/420 case	5040	174.56
44567	70000509	WH	1 ¾" x 2", 10 pots/510 case	5100	127.11
44568	70000510	WH	1 ½" x 2 ½", 12 pots/390 case	4680	130.20
44570	70000513	WH	2 ¼" x 2 ¼", 12 pots/210 case	2520	102.79
44572	70000552	WH	2 ½" x 2 ¼", 8 pots/288 case	2304	86.07
44573	70000481	WH	2 ¼" x 3", 8 pots/320 case	2560	106.33
44571	70000514	NH	2 ½" x 6", 8 pots/200 case	1600	106.91
44574	70000365	SL	3" x 3", 6 pots/210 case	1260	88.95

SL = Slits, WH = With Holes



ORGANIC PEET

The J70 is a must-try "container and media in one" concept brought to the organic market by Jiffy. It is a food grade substrate (which is heat treated) contained within the netting to eliminate loose substrate (always forms a plug protecting the root system) from re-circulating water systems.

- Used in Raft hydroponic systems, NFT operations, or any system requiring "plug & play" format
- OMRI listed and used worldwide for a variety of microgreens, lettuce, herbs, and other food products
- Available in dry diameters from 18 mm-70 mm



Item #	Mfr #	Description	Case Pk	Price (\$)
Loose				
51929	70000934	42 x 43 loose	1,500	39.12
51930	70000938	70 x 70 stack	180	18.24
Pellet Pack				
51932	70000917	30x65-105	1,470	49.85
51933	70000918	36x41-72	1,440	49.92
51935	70000919	42x43-50	1,750	105.76
51931	70000952	18x32-300C	6,600	304.79
51934	70000920	70x70-18	216	50.27



JIFFYPOT® R2
Degradable Durability!

Featuring most of the robust features of the original JIFFYPOT, the JIFFYPOT R2 has the added characteristic of keeping the pot dry, even when exposed to water or humid substrate. The dryness of the container persists for a period depending on the ambient humidity, irrigation, substrate, and temperature. Yet, the R2 maintains its rigid form and clean surface long enough to produce herbs, bedding plants, and more.

- Easy-to-use in automatic dispensing equipment
- Due to rigid form, automatic spacing is possible
- Rigid form makes packing easier
- No nitrogen binding; no growth of mold or fungus
- No root spiraling due to coarse surface of inner pot

Item #	Mfr #	Size	Case Pk	Price (\$)
49773	70000904	4.96" round w/hole	600	79.50
49774	70000910	3.86" round w/hole	1100	89.50
49775	70000928	4.33" round w/hole	1100	75.00

*Custom sizes available upon request.



JIFFY-7 PEAT PELLETS

Jiffy-7 is a proven technology based on the labor saving “container and media in one” principle. The Jiffy-7 is an easy-to-use and cost effective rooting media well suited to the propagation of many different crops.

- “Open Wall Container” concept reduces root damage and promotes heavy root development
- Air-pruning forces root development to make better root mass, leading to a faster transplant start



Item #	Mfr #	Type	Description/Size (mm)	Pellets/Cs	Price (\$)
48280	7000092	PP	50 x 150-32E, pallet	216	34.16
48282	7000074	S	18 x 42-bulk	5000	176.96
48284	70000133	PP	25 x 35-34, strip	2856	210.64
48285	70000165	S	25 x 32-bulk	3312	103.72
48286	70000132	PP	30 x 35-25NW, strip	1875	93.15
48289	70000175	S	30 x 35-bulk	1700	92.91
44548	70000147	PP	30 x 55-25, strip	1200	82.19
48295	70000116	S	42 x 42-bulk	1000	78.16
44535	70000121	S	42 x 63-bulk	520	48.17

PP = Pellet Pack (Pellets packed in tray or strip); S = Stacked/Bulk; L = Loose (Pellet stacked neatly in case w/out tray or strip)

CAREFREE

Carefree Jiffy Mix is fully contained in a polymeric netting that helps keep the greenhouse environment clean.

- Fast expansion and root development assures problem-free transplanting
- Automation ready system
- Reduces costs throughout the full crop cycle
- Can be a “pot-free” consumer or landscaper solution reducing site cleanup



Item #	Mfr #	Type	Description/Size (mm)	Case Pk	Price (\$)
48298	70000080	PP	23 x 45-105, tray	1050	69.27
48299	70000078	S	23 x 45-stacked	1352	88.19
48301	70000704	PP	25 x 45-26, strip	1170	76.53
48302	70000314	S	25 x 45-stacked	1152	50.75
48304	70000363	PP	30 x 40-26	1092	67.69
48305	70000285	PP	30 x 40-50, tray	750	51.97
48307	70000166	S	30 x 40-stacked	900	72.60
48308	70000168	PP	36 x 40-72, tray	1008	66.67
48309	70000294	S	36 x 40-stacked	1120	53.31
48312	70000639	S	50 x 60-bulk	594	53.03
48313	70000663	S	70 x 70-stacked	160	31.16

PP = Pellet Pack (Pellets packed in tray or strip); S = Stacked/Bulk; L = Loose (Pellet stacked neatly in case w/out tray or strip)

PREFORMA® PLANT PLUGS

Preforma Plant Plugs are manufactured from the highest quality substrates and held together with a unique binding agent. Preforma achieves unrivalled rooting speeds in propagation.



- Offers the flexibility of plug size, depth, shape and cell density to match the needs of the individual grower
- Fits all automated systems
- Increased returns – crops that have been traditionally propagated in one season for sales in the next season can be propagated and sold in the same season with Preforma
- Sticking speeds are up to 20% faster than in other discrete plugs
- Eliminates labor needed to fill or water trays filled with loose substrates
- Highly stable media reduces bench and shipping losses
- Pre-drilled for quick and easy insertion of the cuttings

Item #	Mfr #	Description	Trays/Pallet	Cells/Pallet	Price (\$)
50 Cell Trays					
48314	80000775	Dongjin 50, bl 3	208	10,000	3.60 ea
48315	80000794	Landmark 50T, bl 3	300	15,000	3.60 ea
60 Cell Trays					
48316	80000795	Dillen 60 strip sheet, bl 3	260	13,200	3.60 ea
72 Cell Trays					
48317	80000799	Dongjin 72 tray, bl 3	208	14,400	3.60 ea
48318	80000787	Dillen 72 strip sheet, bl 3	260	15,840	3.60 ea
75 Cell Trays					
48319	80000421	Dillen 75 strip sheet, bl 3	300	19,500	3.68 ea
78 Cell Trays					
48320	80000321	Jiffy 3 x 26 strip, 78 tray bl 3	288	18,720	4.40 ea
84 Cell Trays					
48321	80000816	Dillen 84T, bl 3	290	21,000	3.60 ea
48322	80000261	EJ 84T, bl 3 circular	310	23,500	3.70 ea
102 Cell Trays					
48323	80000842	Landmark 102/51, bl 3	248	24,480	3.67 ea
105 Cell Trays					
48324	80000804	Dillen 105 hex, bl 3	240	25,200	3.60 ea
48325	80000845	Landmark 105 hex, bl 3	272	25,200	3.67 ea
288 Cell Trays					
48326	80000824	Dongjin 288, bl 3	416	69,120	4.40 ea
48327	80000849	Landmark 288, bl 3	416	92,160	3.67 ea

Sold by the pallet, minimum order of two pallets.

One Call – Plants/Plugs, Seeds, Bulbs, and Supplies, only at Gloeckner!



Jiffy Mix #1 – Standard growing blend with Canadian/ European Peat and coarse perlite. This mix has the look and feel of standard U.S. growing mixes with good drainage.

Jiffy Mix #2 – Standard growing blend with Canadian/ European Peat and coarse perlite. This mix has the look and feel of standard U.S. growing mixes with a little less drainage than #1.

Jiffy Mix #3 – A popular medium weight mix that contains bark, coarse perlite and Canadian and European Peat. This mix can be used with flats, pots and baskets.

Jiffy Mix #3-1 – A popular medium-heavyweight mix with bark and coarse perlite with Canadian and European Peat. This mix works well with most crops and large cell packs/ flats, pots and baskets.

Jiffy Mix #5 – High porosity mix with Canadian/European Peat and coarse perlite. This mix has the look and feel of standard U.S. growing mixes with excellent drainage.

Jiffy Mix #8-E with COIR (Jiffy Plug) – Unique blend with European fractioned peat and medium perlite with COIR is designed for growers who work with paper plug systems. This mix contains Jiffy's own brand of COIR that is RHP Certified.

Jiffy Mix #9 with COIR – A propagation mix with COIR and coarse perlite to enhance moisture control on the bench blended with Canadian and European Peat for URC propagation, as well as small containers.

Jiffy Mix #13 (OMRI Listed) – A propagation mix with an organic fertilizer in place of the regular nutrient charge, with Coir added to enhance moisture control on the propagation bench. Additionally, mix is blended with Canadian Peat. This general purpose propagation mix works great on a wide range of crops from plug seeding areas to URC cutting production.

Jiffy Mix #17-1 Seedling (Plugs) – A high quality, special screened peat based mix with medium perlite and vermiculite, designed for seedling production. Also available in low pH and high pH blends.

Jiffy Mix #24-CM (Vegetable Blend) – A high quality vegetable blend, with a unique European fertilizer starter charge that is specifically designed for vegetable production in packs, flats, and pots.

Jiffy Mother's Mix – An all-natural and organic OMRI Certified Mix from Jiffy that available is 1.5 cu ft bags for *retail garden centers*. It is also available in 2.8 cu ft Jiffy bags and 65 cu ft bulk bags for wholesale growers. This mix contains rich organic materials, and a natural fertilizer to help get your plants off to a great start. All natural ingredients make this mix a great choice for annuals and vegetables.

Item #	Mfr #	Size	Qty/Pallet	Price (\$)
Jiffy Mix #1				
48679	8500011072	2.8 cu ft	45	
48680	8500018065	65 cu ft	2	
48681	8500019220	110 bale	1	
49328	8500018080	80 cu ft	2	
Jiffy Mix #2				
48682	8500021072	2.8 cu ft	45	
48683	8500028065	65 cu ft	2	
48684	8500029220	110 bale	1	
49329	8500028080	80 cu ft	2	
Jiffy Mix #3				
48685	8500031072	2.8 cu ft	45	
48686	8500038065	65 cu ft	2	
49330	8500038080	80 cu ft	2	

Call for Real Time Pricing.

Item #	Mfr #	Size	Qty/Pallet	Price (\$)
Jiffy Mix #3-1				
48698	8500441072	2.8 cu ft	45	
48699	8500448065	65 cu ft	2	
Jiffy Mix #5				
48687	8500051072	2.8 cu ft	45	
48688	8500058065	65 cu ft	2	
48689	8500059220	110 bale	1	
Jiffy Mix #8-E with COIR				
48700	8500531072	2.8 cu ft	45	
48701	8500538065	65 cu ft	2	
Jiffy Mix #9 with COIR				
48690	8500091072	2.8 cu ft	45	
48691	8500098065	65 cu ft	2	

Call for Real Time Pricing.

Item #	Mfr #	Size	Qty/Pallet	Price (\$)
Jiffy Mix #13				
49867	8500281072	2.8 cu ft	45	
49868	8500288065	65 cu ft	2	
Jiffy Mix #17-1 Seedling				
48702	8500771072	2.8 cu ft	45	
48703	8500778065	65 cu ft	2	
48704	8500779220	110 bale	1	
Jiffy Mix #24-CM				
48695	8500411072	2.8 cu ft	45	
48696	8500418065	65 cu ft	2	
48697	8500419220	110 bale	1	
Jiffy Mother's Mix				
48705	8500301038	1.5 cu ft	60	
49452	8500301072	2.8 cu ft	45	

Call for Real Time Pricing.



Jiffy's mission is to provide growers with the highest quality growing media, media containers, and other supporting products or services which enhance the successful propagation or cultivation, marketing, and sales of plants.

BM6 HIGH POROSITY MIX

Mixes in the BM6 group have been formulated for water sensitive and winter plantings. The combination of coarse peat and horticultural perlite encourages quick drainage and high aeration.

Item #	Size	Qty/Pallet	Approx. Weight	Price (\$)
47606	3 cu/ft loose	54	13.6 kg, (30 lbs)	
47607	3.8 cu/ft compressed	30	29.5 kg, (65 lbs)	<i>Call for Real Time Pricing.</i>
47608	75 cu/ft loose	2	350 kg, (772 lbs)	
47609	Skyscraper 110 cu/ft compressed	1	880 kg, (1,940 lbs)	



Berger Mix Sold by Truck Load Only



BM8 COMPOSTED SPHAGNUM PEAT MOSS

The composted sphagnum peat moss increases water retention, cation exchange capacity (CEC), and apparent density. It also carries beneficial microorganisms that can be beneficial to the plants. The structure of the composted sphagnum peat moss also improves the water distribution throughout the mix.

Item #	Size	Qty/Pallet	Approx. Weight	Price (\$)
49755	3 cu/ft loose	51	15.45 kg (34 lbs)	
49757	75 cu/ft loose	2	400.9 kg (882 lbs)	<i>Call for Real Time Pricing.</i>
49756	3.8 cu/ft compressed	30	40.9 kg (90 lbs)	
49758	Skyscraper 110 cu/ft compressed	1	931.8 kg (2,050 lbs)	

Components: Sphagnum peat moss (coarse), horticultural perlite, dolomitic and calcitic lime, initial fertilizer, initial fertilizer charge and wetting agent.

BM1 ALL PURPOSE MIX

This family of all purpose mix is ideal for a wide variety of plants. Its composition of long fiber peat moss, perlite, vermiculite and starter fertilizer charge promotes a rapid root growth and uniform crop.

Item #	Size	Qty/Pallet	Approx. Weight	Price (\$)
47610	3 cu/ft loose	54	13.6 kg, (30 lbs)	
47611	3.8 cu/ft compressed	30	29.5 kg, (65 lbs)	<i>Call for Real Time Pricing.</i>
47612	75 cu/ft loose	2	350 kg, (772 lbs)	
47613	Skyscraper 110 cu/ft compressed	1	880 kg, (1,940 lbs)	



Components: Sphagnum peat moss (coarse), horticultural perlite, horticultural vermiculite, dolomitic and calcitic lime, initial fertilizer charge and wetting agent.

BM2 GERMINATING MIX

This group of mix is specifically formulated for seed germination in either plugs, trays, or floating systems. Composed of specifically designed particle size peat moss, perlite and vermiculite, the BM2 mix series promotes uniform germination and rapid root development.

Item #	Size	Qty/Pallet	Approx. Weight	Price (\$)
47614	3 cu/ft loose	54	15.9 kg, (35 lbs)	
47615	3.8 cu/ft compressed	30	36.3 kg, (80 lbs)	<i>Call for Real Time Pricing.</i>
47616	75 cu/ft loose	2	325 kg, (717 lbs)	
47617	Skyscraper 110 cu/ft compressed	1	953 kg, (2,101 lbs)	



Components: Sphagnum peat moss (fine), fine perlite, fine vermiculite, dolomitic and calcitic lime, initial fertilizer charge and wetting agent.

BM7 PEAT MOSS W/PINE BARK

Produced with pine bark, the BM7 series is formulated for perennials, shrubs, and trees. It can also be used for applications needing heavy weight.

Item #	Size	Qty/Pallet	Approx. Weight	Price (\$)
49751	3 cu/ft loose	48	19.09 kg (42 lbs)	<i>Call for Real Time Pricing.</i>
49753	75 cu/ft loose	2	45.46 kg (1,000 lbs)	



OM1 ORGANIC ALL PURPOSE MIX

This organic mix uses selected coarse Canadian sphagnum peat moss, perlite, vermiculite, composted peat and organic starter charge providing plants with the ideal root environment leading to a rapid root development and healthy uniform crop.

Item #	Size	Qty/Pallet	Approx. Weight	Price (\$)
47618	3 cu/ft loose	54	13.6 kg, (30 lbs)	<i>Call for Real Time Pricing.</i>
47619	3.8 cu/ft compressed	30	29.5 kg, (65 lbs)	
47620	Skyscraper 110 cu/ft compressed	1	880 kg, (1,940 lbs)	



oasis® GROWER SOLUTIONS TERRA PLUG – Bonded Media Plug

Engineered for Cutting and Seed Propagation

OASIS® Grower Solutions' Terra Plug is a bonded media manufactured using a unique horticultural-friendly patented technology. The uniform density within the Terra Plug from top to bottom promotes the plant to root throughout the media, allowing for better access and utilization of water and nutrient inputs. Each tray of Terra Plugs comes ready-to-use with ideal moisture content.



- Easy extraction from trays for both manual and automated transplant
- Keeps original structures of the media fibers to provide optimal air/water porosity
- Fast and uniform rooting with development of strong fibrous root system
- Early transplant, even before the plants are well rooted
- Does not shrink
- Easy to re-water

Sold by the pallet only.

Item #	Mfr #	Description	Plugs/Plt	Trays/Plt	Price/Plt (\$)
51953	87-61050	50-ct Terra Plug	17,600	352	1,545.00
51954	87-61078	78-ct Terra Plug	22,464	288	1,545.00
51955	87-61096	96-ct Terra Plug	33,792	352	1,545.00
51956	87-61102	102-ct Terra Plug	33,456	328	1,545.00
51957	87-61102S	102-ct Terra Plug Split Tray	33,456	328	1,545.00
51958	87-61105	105-ct Terra Plug	37,800	360	1,545.00
49807	87-61128	128-ct Terra Plug	41,984	328	1,545.00
51959	87-61200	200-ct Terra Plug	67,200	336	1,545.00
51960	87-61050L	50-ct Terra Plug	17,600	352	1,545.00
51961	87-61050D	50-ct Terra Plug Round Deepcell	11,200	224	1,545.00
49803	87-61072	72-ct Terra Plug	23,616	328	1,545.00



GROWING MEDIUM

OASIS® Growing Medium is a rigid, open-celled, water-absorbing foam specifically designed for optimal callus and rapid root development.

- Sterile medium arrives pathogen-free, to reduce disease and insect problems
- Unique cell structure mimics the cellular structure of the plant itself, assuring proper drainage and water holding
- Roots remain undisturbed during transplant, eliminating plant shock
- Low cation exchange capacity allows rapid nutrient availability without danger of salt accumulation
- Unique “Universal” star dibble hole accommodates most stem sizes for ease of sticking

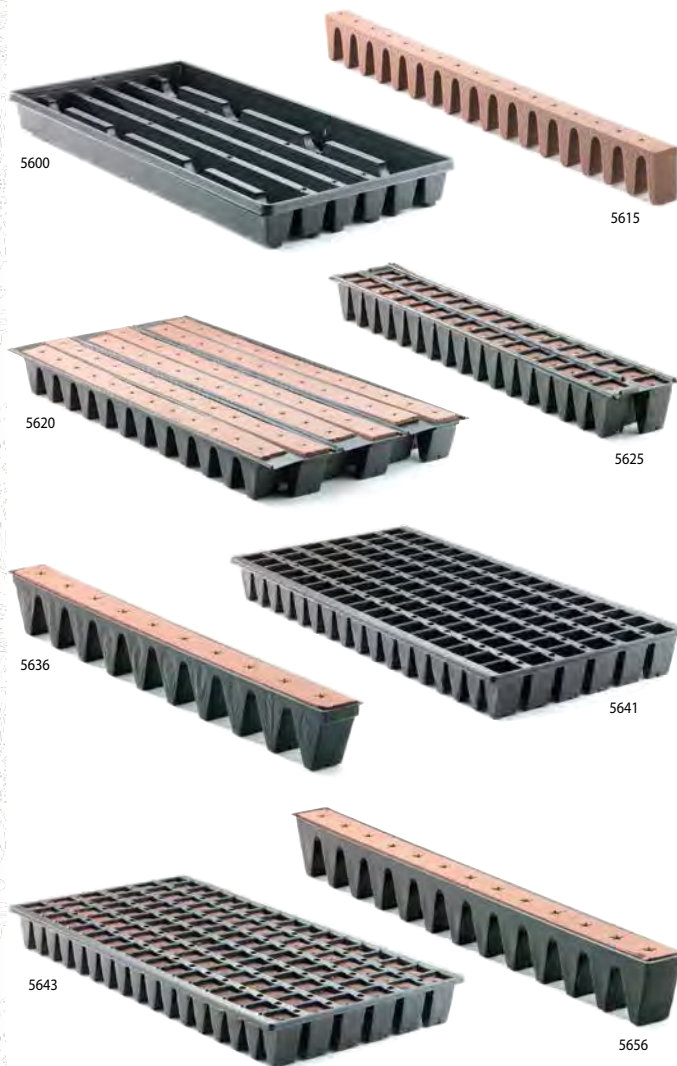

ROOTCUBES® WEDGE® FOAM MEDIUM

Engineered Media with tapered plug design for consistent and uniform rooting

- Engineered foam medium with the unique shape that tapers from top to bottom; optimal air to water ratios for fast, uniform rooting, this unique shape aids in directing roots downward for a more rapid development, resulting in greater crop turnover and overall productivity for the grower
- Each cell is singulated, therefore, there is no tangling of the fibrous root systems
- Ready to use media: available in many shapes and configurations for maximum flexibility

Item #	Mfr #	Description	Plugs/Case	Case Pk	Cases/Pallet	Price (\$)
51962	87-50010	10-ct Wedge Strips	2,240	224	16	176.00
51963	5680	12-ct Rootcubes Strip with Plastic	2,112	176	12	165.33
51964	5646	13-ct Long Wedge Refill Foam Only	4,368	336	12	66.13
51965	5648	13-ct Long Wedge Strip	3,744	288	12	176.00
51966	87-50013	13-ct Wedge Strip	2,912	224	16	219.73
45290	5615	34-ct Wedge Refill Strips – Foam	2,040	60	40	60.80
45287	5625	34-ct Wedge Double Strips	2,448	72	16	176.00
45298	5643	102-ct Wedge Filled Trays	1,020	10	40	55.47
51967	5615NH	34-ct No-Hole Wedge Refills – Foam Only	2,040	60	40	50.13
45288	5600	Carrier Tray for Wedge 10, 13, and 34-ct		75	32	109.87
51968	87-50224	Strip Connector Clip w/Wedge 10 and 13-ct	224	280	196	7.47
45291	5641	Tray only for 102-ct Wedge 10 x 20		40	24	71.47

ROOTCUBES® PLUS WEDGE® FOAM MEDIUM FOR POINSETTIAS

Tapered design developed exclusively for Poinsettia Propagation

- First propagation media designed to improve the rooting performance of poinsettias
- Speeds up the poinsettia propagation process by five days, resulting in faster crop turnover and improved greenhouse efficiency
- Provides more uniform and consistent root development, reducing transplant shock and crop shrink

Item #	Mfr #	Description	Plugs/Case	Case Pk	Cases/Pallet	Price (\$)
51969	87-55010	10-ct Rootcubes Plus Wedge Strips	2,240	224	12	176.00
51970	87-55013	13-ct Rootcubes Plus Wedge Strips	2,912	224	12	176.00
51971	87-55135	13-ct Rootcubes Plus Wedge Star Dibble 336 Strips x 13 Units	4,368	336	12	55.47

Note: Orders under \$2,675.00, shipping and handling charges will apply (FOB OH). Orders over \$2,675.00, freight is pre-paid (delivered).

ROOTCUBES® FOAM MEDIUM *Engineered media for increased rooting success*

OASIS® Grower Solutions hydrophilic foam in sheet form, with individual cells shaped like cubes that contain just the right amount of starter nutrients and provide an ideal balance ratio of air and water.

- Comes in sheet form, with easy to separate cubes
- Available in sheets of various configurations or liners that fit conveniently into a standard “1020” plastic tray
- Crops most commonly propagated from unrooted cuttings in Rootcubes® media: poinsettias, geraniums, hibiscus, New Guinea impatiens, fuchsia, foliage, perennials, and woody ornamentals

Item #	Mfr #	Description	Size (Column x Row)	Case Pk	Price (\$)
45283	5005	1" Medium	162 cells/sheet (9 x 18)	20 sheets	77.87
45284	5010	1 ¼" Medium	104 cells/sheet (8 x 13)	20 sheets	77.87
45285	5015	1 ½" Medium	50 cells/sheet (5 x 10)	20 sheets	77.87
45286	5020	Medium 10 Strip	10 cells/strip (1 x 10)	190 strips	88.53



HORTICUBES® FOAM MEDIUM *Fast, Clean, and Consistent Growing for Hydroponics*

- A lower density, higher drainage foam is specially engineered for hydroponics seed germination of vegetables and herbs
- High drainage product characteristic is ideal for crops requiring high air porosity
- Specifically engineered balance of water and air promotes vigorous root development
- “Sheet” style fits easily on a bench or into industry standard “1020” trays, and each sheet is pre-scored for easy removal of a single cube, block of cubes, or strip of cubes
- Maintains the original air porosity; the cells do not compact after continual watering
- Pre-dibbled seed holes are uniform in depth and spacing, which makes it easy to automate the seeding process
- No starter fertilizer for maximum nutrient flexibility

Item #	Mfr #	Description	Cell Size*	Case Pk	Price (\$)
45278	5225	1" Medium – 162 cells/sheet	Cube: 7/8" x 7/8" x 1 1/2" Center holes: 1 1/8" apart	20 sheets	88.53
45279	5231	1" Thin-cut Medium – 276 cells/sheet	Cube: 3/4" x 7/8" x 1 1/2" Center holes: 7/8" apart	20 sheets	88.53
45280	5240	1 ¼" Medium – 104 cells/sheet	Cube: 1" x 1 ¼" x 1 ½" Center holes: 1¼" apart	20 sheets	88.53
45281	5245	1 ½" Medium – 50 cells/sheet	Cube: 1 ¾" x 1 ¾" x 1 ½" Center holes: 1 ¼" apart	20 sheets	88.53



Note: Orders under \$2,675.00, shipping and handling charges will apply (FOB OH). Orders over \$2,675.00, freight is pre-paid (delivered).

*Cube sizes may vary slightly due to the fragile nature of the media.

FERTISS® STABILIZED MEDIA *Easy and Ready-to-Stick Propagation Media for Young Plant Production*

OASIS® Grower Solutions’ Fertiss® is a ready-to-use plug, in trays with a consistent and even soilless cutting and seed propagation media blend. The OGS Fertiss® media mix is composed of a special blend of long-fiber sphagnum peat moss, perlite and vermiculite that is bound by a cellulose non-woven net.

- Easy to insert: loose, open mix makes it easy to insert cuttings
- Promotes natural air pruning: uniquely developed trays avoid root spiraling and encourage development of dense fibrous roots system
- Ideal for slow-to-root cultivars
- Easy to transplant and ship young plants
- Consistent and even media blend, pH adjusted
- High quality wetting agent to promote quick saturation and enhanced rewetting
- Stacking trays do not compress the plug media

Item #	Mfr #	Description	Plug Size	Pallet/Pk	Price (\$)
47594	5305P2	105-ct Tray	3 x 4 cm	400 Trays	1,391.00
47595	87-53020	102-ct Tray	2.5 x 3 cm	496 Trays	1,854.00
47596	5372P2	72-ct Tray	3.2 x 3.5 cm	480 Trays	1,339.00
47597	5360P	6 x 10-ct Strips	3 x 4 cm	280 Trays	876.00
47598	87-53510	51-ct Half Tray	2.5 x 3 cm	992 Trays	1,751.00
47599	5350P2	50-ct Tray	4 x 5 cm	320 Trays	1,030.75
47600	5350LP2	50-ct Tall Tray	4 x 6 cm	304 Trays	1,030.25
47601	5332P	32-ct Tray	5.2 x 4.5 cm	352 Trays	1,113.00
47602	5326P	26-ct Strip	3 x 4 cm	1,012 Strips	1,082.00
47603	5325P	25-ct Strip	3 x 4 cm	1,192 Strips	1,288.00
47604	5318P	18-ct Tray	7 x 7 cm	224 Trays	824.00



Item #	Mfr #	Description	Plug Size	Case Pk	Price (\$)
49484	5350C	50-ct Tray	4 x 5 cm	10 Trays	44.80
49485	5350LC	50-ct Tall Tray	4 x 6 cm	10 Trays	44.80
49486	5332C	32-ct Tray	5.2 x 4.5 cm	11 Trays	44.80
49487	5326C	26-ct Strip	3 x 4 cm	60 Strips	82.20
49488	5325C	25-ct Strip	3 x 4 cm	60 Strips	69.33

Fertiss medium with trays shipped F.O.B. Ohio.



The Plant Marvel Story – Over 95 Years of Pioneering Quality Fertilizing Materials!

Established in 1922, Plant Marvel has been a pioneer and popularized the use of *water soluble fertilizers*. With the introduction in 1924 of the 12-31-14 General Purpose Hi Phosphate formulation, Plant Marvel helped fuel the growth of soilless growing and hydroponics. Years later, Plant Marvel was the first company to successfully find a way to incorporate soluble forms of minor and trace elements into its expanding line of soluble N-P-K Fertilizers. This was the first commercial solution to deliver a total nutrient feed to crops without fear of burning the plants. Other Plant Marvel *firsts* include:

- *First* to produce a high-concentrate water-soluble fertilizer
- *First* to incorporate minor and trace minerals in significant quantities and in a soluble form that was readily available to plants
- *First* to market a starter solution for faster development of new crops
- *First* to promote various formulas specifically designed for the changing needs of crops at different stages of growth
- *First* to develop fertilizers specifically to offset the effect of crops suffering from toxicity caused by excess mineral content in the water or soil mix
- *First* to promote ratios to accomplish specific growth characteristics
- *First* to develop the CalMag soluble fertilizers that contain NPK plus significant levels of Calcium, Magnesium and minor elements in one blend

Plant Marvel is still committed to ongoing research, and ultimately delivering new breakthrough fertilizers to the commercial growers, giving them the tools they need to grow the best and most profitable plants.

**NUTRICULTURE®
EVERYDAY FERTILIZERS**



Item #	Description	Formula	Price (\$)
44888	Hydroponic Spec	4-18-38 Plus	24.40
44889	Super Blossom	5-40-17 Plus	24.40
47403	K-Blast	9-15-30	23.80
44859	Blossom Buster	10-30-20 Plus	25.00
45973	Cyclamen Finisher	11-8-27 Plus	22.50
44860	Bloom & Flower	12-31-14 Plus	23.80
44861	Super Start	12-45-10 Plus	25.00
44862	Hi-K Special	13-0-44 Plus	25.00
44876	Plug Special	14-0-14 Plus	19.40
47404	Cal-Mag	14-3-20 Plus	20.65
47103	Cal-Mag	15-0-14 Plus	21.30
44864	Hi-Cal Special	15-0-15 Plus	18.80
47200	Poinsettia	15-3-18 Plus-P	20.95
44880	Pansy Special	15-3-20 Plus-PZ	21.60
44866	Poinsettia Special	15-5-25 Plus	22.50
45971	K-Mag Special	15-5-30 Plus	22.50
44867	Pot Mum Special	15-10-30 Plus	22.50
44868	Easter Lily Special	16-4-12 Plus	23.80
47405	A-Tank	16-5-16	18.80
47406	B-Tank (Micros)	16-5-16	16.30
47098	Potted Plant Special	17-0-17 Plus	19.40
47284	Cal-Mag Special w/Molybdenum	17-5-17 Plus-MO	21.30
44869	Geranium & Bedding Plant Special	17-17-17 Plus	23.20
44871	Cal Special	20-0-20 Plus	18.80
44877	Hi-Nitrate Special	20-5-30 Plus	23.20
44874	General Purpose for Alkaline Water	20-7-20 Plus	21.90
44878	Acid	21-7-7 Plus-A	18.20
47201	Azalea Neutral	21-7-7 Plus-N	21.30
47202	Grower's Special Blend	21-8-18 Plus	21.90
44882	Tree & Shrub Special	25-15-10 Plus	21.30
44885	Hi Acid	28-18-8 Plus	20.00
44887	Ornamental Special	30-10-10 Plus	18.80

Blue Fertilizer Dye

This highly concentrated formulation is an effective blue color tracer for checking injector flow. Dye is non-staining and non-toxic and easily washes off hands, clothing and most surfaces.



Item #	Description	Price (\$)
41201	Bottle/PT	23.80

Sol-Trace

Soluble trace element mix will quickly overcome micronutrient deficiencies. Can be used to supplement micronutrients under low NPK feed rates.



Item #	Description	Price (\$)
44894	1 case (6 x 5 lb bag)	58.75
44892	25 lb bag	50.00



Plug Special 13-2-13 PLUS
(With 6% Calcium & 3% Magnesium)

- Formulated with high nitrate nitrogen, calcium, magnesium, and minor trace elements, mostly derived from the chelated (EDTA) form, and all combined into a totally soluble mix
- Formulated especially for plug production or any crop that may be sensitive to ammoniacal nitrogen during low light periods
- Develops strong roots and vibrant seedlings

Item #	Formula	Price (\$)
44863	13-2-13 PLUS	18.80

Cal-Mag Special 15-3-18 PLUS
(With 6% Calcium & 1% Magnesium)

- Features high nitrate N with Ca, Mg, and P
- Formulation stiffens stems
- Stepped up amount of potash ensures good and healthy cell wall development

Item #	Formula	Price (\$)
45970	15-3-18 PLUS	20.70

Cal-Mag Special 16-3-16 PLUS
(With Iron EDTA & EDDHA)

- Combination of two different forms of iron chelates makes iron available over a broader pH range, as well as wet soil conditions, ensuring availability under alkaline soil conditions
- Helps control the tendency to stretch and promotes healthier growth while inducing excellent longer keeping blooms

Item #	Formula	Price (\$)
47894	16-3-16 PLUS	20.00

Cal-Mag Special 15-5-15 PLUS
(With 5% Calcium & 2% Magnesium)

- Balanced fertilizer making an excellent general purpose feed for low bicarbonate waters

Item #	Formula	Price (\$)
44884	15-5-15 PLUS	20.70

BEST SELLERS



Cal-Mag Special 17-5-17 PLUS
(With 4% Calcium & 1% Magnesium)

- NPK, Ca, Mg, and trace minerals all in one great mix, high nitrate N
- Calcium to magnesium ratio is perfectly proportioned so that they will not impede one another's uptake by acting as an antagonist
- Performs as formulated without a major impact on pH

Item #	Formula	Price (\$)
45969	17-5-17 PLUS	20.70

Potted Plant Special 18-3-18 PLUS
(With 6.65% Calcium)

- Contains phosphorus, Ca, and Mg all in one great mix
- Chelated trace elements
- High nitrate nitrogen

Item #	Formula	Price (\$)
47100	18-3-18 PLUS	21.30

Mag-Iron Special 18-6-18 PLUS
(Provides Iron and Magnesium over a broad pH range)

- Ideal for growers with high calcium bicarbonate water who need to complement their magnesium level
- Elevated iron chelated in two forms to handle a broader media pH range
- High nitrate nitrogen

Item #	Formula	Price (\$)
47101	18-6-18 PLUS	21.90



Cal-Mag GP 20-5-20 PLUS
(With 2% Calcium & .25% Magnesium)

- Designed for growers with relatively pure water as an ammonium based feed containing calcium and magnesium
- Contains phosphorus, Ca, and Mg all in one great mix
- Chelated trace elements, high nitrate nitrogen

Item #	Formula	Price (\$)
44872	20-5-20 PLUS	21.90

General Purpose 20-10-20 PLUS

- Ideal use as an all purpose foliar application or root feed on ornamentals, turf and nursery stock
- Higher levels of nitrate N
- Fully chelated minors
- 100% soluble

Item #	Formula	Price (\$)
44873	20-10-20 PLUS	22.50

General Purpose 20-20-20 PLUS

- Widely used on containerized stock in the industry and for greenhouse crops as foliage plants and bedding plants
- NPH and trace elements all in one great mix
- Fully chelated minors

Item #	Formula	Price (\$)
44875	20-20-20 PLUS	21.30

Sodium Molybdate

- Ideal additive for the production of high quality trace elements, discourages upward rolling and edge burn of leaf
- Comes in easy-to-apply pre-measured packets

Item #	Formula	Case Pk	Price (\$)
47107	Sodium Molybdate, 1 oz packet	25/box	57.90

Refer to pages 146-147 for technical support information on fertilizer applications.



FERTILIZERS

Originators of the World Famous "True Blue™" Water-Soluble Fertilizer

JR Peters Inc. offers professional greenhouse growers over 60 stock formulations of Jack's Professional water-soluble fertilizers to choose from. All formulas are custom blended. Additional products containing no boron or dye are available upon request. *Jack's Professional Fertilizers can only be purchased through professional dealers like Gloeckner.*

- U.S.A. made in Allentown, PA based facility
- Made with only the highest quality raw materials, including cutting edge FeED micronutrient technology
- Completely soluble, contains no excess soluble salts
- Packaged in an innovative plastic bag that resists leaks and prevents moisture penetration
- Products feature effective color tracer; the *True Blue* solution will remain visible down to the lowest usable concentration without staining
- Backed by on-site testing laboratory



Jack's Professional FeED – 25 lb Bags

Call for Pre-Paid Prices by Zone

Item #	NPK	Description	FOB Price (\$)
47967	16-4-17	Oasis Hydroponic	41.90
47968	22-5-16	Mum FeED	35.50
44499	20-3-19	Best Seller! Petunia FeED	36.40
44492	17-5-19	Poinsettia FeED Plus Mg	36.90
47969	17-3-19	Fall Pansy FeED	35.30
44482	15-4-15	Best Seller! Poinsettia FeED Cal-Mg	36.30
47296	15-2-20	Spring Pansy FeED Oxidizer	33.70
48989	12-4-16	RO	46.00

Jack's Professional LX – 25 lb Bags

Call for Pre-Paid Prices by Zone

Item #	NPK	Description	FOB Price (\$)
44502	21-5-20	Best Seller! All Purpose Oxidizer	35.00
44500	20-5-19	Poinsettia Oxidizer	35.80
44491	17-4-17	Best Seller! Pure Water	32.70
44483	15-5-15	Ca-Mg Oxidizer	32.90
44471	15-0-0	Cal-Trate	27.00
44472	15-0-14	Dark Weather Plus Mg	31.10
44469	14-5-38	K-Trate	35.40
44467	13-2-13	Best Seller! Plug	30.80
44463	10-0-0	Mag-Trate	30.50
44486	16-2-15	Plug (For High Alkalinity Water)	34.20



Note: Prices listed are FOB, PA for orders under 40 bags. For orders 40 bags plus (½ pallet), shipping charges are FOB destination. Refer to page 47 for the list of zones and states, and call 800-345-3787 for pre-paid price quote by zone. Oxidizer cannot ship by UPS.

Jack's Professional – 25 lb Bags

Call for Pre-Paid Prices by Zone

Item #	NPK	Description	FOB Price (\$)
44504	21-8-18	Magnum with 1% Mg	34.50
47102	25-5-15	Best Seller! High Performance	33.60
44507	27-15-12	Foliar Feed	35.20
44506	24-8-16	Tropical Foliage	32.30
44503	21-7-7	Acid	28.30
44498	20-20-20	Best Seller! General Purpose Oxidizer	34.40
44496	20-10-20	General Purpose	33.20
44497	20-10-20	Best Seller! Peat-Lite Oxidizer	34.70
44495	20-0-20	Hi Cal Peat-Lite Oxidizer	32.00
44493	17-5-24	Low Acid Peat-Lite	33.50
44487	16-4-12	Easter Lily	35.00
44481	15-30-15	Hi Phosphate	36.80
44479	15-20-25	Poinsettia Finisher	37.70
44478	15-16-17	Peat-Lite	35.80
44477	15-15-15	Geranium	35.00
44476	15-11-29	Peat-Lite Oxidizer	36.40
44475	15-10-30	Pot Mum	35.30
44484	15-5-25	Poinsettia Peat-Lite	35.90
44473	15-0-15	Best Seller! Dark Weather	28.10
44474	15-0-15	Dark Weather Peat-Lite	29.60
44464	10-30-20	Blossom Booster	40.10
44509	9-45-15	Plant Starter	39.70
44508	5-12-26	Part A	46.00
44470	15.5-0-0	Calcium Nitrate Part B	43.10
44512	M.O.S.T.	Mix of Soluble Traces	52.50
44513	M.O.S.T.	Mix of Soluble Traces, No Boron	52.50
44465	12-3-15	Orchid RO Type Water	37.50
44488	16-4-20	Orchid Well Water	37.40
48983	30-10-10	Hi Nitro	35.30
48984	25-9-17	Berry Special	35.30
48985	5-50-18	Ultra Violet	51.80

Jack's Aqua Gold High Tunnel

Call for Pre-Paid Prices by Zone

Item #	NPK	Description	FOB Price (\$)
47971	21-8-18	Low Phosphorus	36.40
48986	15-20-28	Grow & Bloom	40.80
48987	15-0-0	Calcium Boost	25.00
48988	7-15-30	Finisher	37.60

Jack's Professional Dry Nutrient Charge – 50 lb Bags

Call for Pre-Paid Prices by Zone

Item #	NPK	Description	FOB Price (\$)
44514	10-5-10	Media Mix Plus III	67.60

Zone 1: PA, NJ, DE, MD
 Zone 2: NY, CT, RI, NH, VT, MA, ME, OH, MI, IN, KY, WV, VA, NC, SC, IL, WI, GA, FL, AL, MS, MO
 Hawaii and Alaska freight prepaid to Los Angeles or Seattle.

Zone 3: OK, AK, IA, LA, KS, NB, MN, ND, SD
 Zone 4: NM, CO, WY, MT, TX
 Zone 5: CA, AZ, UT, NV, ID, OR, WA

CALCIUM CHLORATE DIHYDRATE

- Technical grade (99.7% pure), soluble powder provides an available source of calcium to be sprayed on the leaves of poinsettias or other crops
- Useful in situations when drenching calcium containing fertilizer is not enough to provide the needed calcium for proper leaf or bract expansion
- Undergoes the strict QA/QC guidelines of all Jack's products so to ensure that there are no impurities or by-products that can be harmful to the plant and lead to leaf burn
- Weekly applications of a fine mist of solution containing 200-400 ppm CaCl₂ should be sufficient in providing available calcium during poinsettia production



Item #	Description	Price (\$)
49341	1 lb	18.95

EPSOM SALTS (MgSO₄·7H₂O, Magnesium Heptahydrate)

- Ideal for providing a very soluble boost of both of these elements to any fertility program
- Fine grain, crystalline Epsom Salts is a pure mineral compound of both Magnesium and Sulfur
- High quality and purity conforms to the QA/QC standards of all of Jack's Fertilizer products
- At a rate of 4-8 oz. per 100 gallons, plants can revive their healthy green glow



Item #	Description	Case Pk	Price (\$)
49742	1 lb	12	8.50/ea
49743	4 lbs	6	13.00/ea
49744	25 lbs	1	26.50/ea

AMMONIUM MOLYBDATE

Used as a fertilizer supplement for poinsettias and many vegetable crops. It can be incorporated into the liquid feed program or used as a foliar spray.

Item #	Description	Price (\$)
41200	1 lb container	52.00



CITRIC ACID

- 99.9% pure technical grade citric acid (C6H8O7) is used as an acidifier in many greenhouse settings; packaged in both a plastic bag and tub to ensure freshness
- Appears as white crystals and is very soluble in water
- High quality and purity of this grade of Citric Acid conforms to the QA/QC standards of all of Jack's Fertilizer products



Item #	Description	Case Pk	Price (\$)
49739	1 lb	12	15.00/ea
49740	4 lbs	6	30.00/ea
49741	25 lbs	1	68.75/ea



FERTILIZERS WITH POLYON® TECHNOLOGY

The Fred C. Gloeckner Company and Harrell's have teamed up to bring you the most advanced controlled release fertilizers on the market today. Harrell's controlled release fertilizer is powered by proven POLYON® technology which is exclusive to Harrell's.



14-14-14 (3-4 Month Release*/Equal Ratio of NPK)

Guaranteed Analysis	
Total Nitrogen (N)	14.0000% (7.3360% Nitrate Nitrogen, 6.6640% Ammoniacal Nitrogen)
Available Phosphate (P ₂ O ₅)	14.0000%
Soluble Potash (K ₂ O)	14.0000%
Calcium (Ca)	2.0000%

Derived From: Polymer Coated Ammonium Nitrate, Ammonium Phosphate, and Sulfate of Potash.

Item #	Formula	Price (\$) 1-19 Bags	Price (\$) 20+ Bags
49438	14-14-14	58.00	54.50

17-6-12 with Minors (3-4 Month Release*/Equal Ratio of NPK)

Guaranteed Analysis	
Total Nitrogen (N)	17.0000% (8.5460% Nitrate Nitrogen, 8.4540% Ammoniacal Nitrogen)
Available Phosphate (P ₂ O ₅)	6.0000%
Soluble Potash (K ₂ O)	12.0000%
Magnesium (Mg)	0.7000% (0.7000% water soluble Magnesium)
Iron (Fe)	0.1650% (0.1650% Chelated Iron)
Manganese (Mn)	0.0650% (0.0650% water soluble Manganese)
Molybdenum (Mo)	0.0060%

Derived From: Polymer Coated: Ammonium Nitrate, Ammonium Phosphate, Monoammonium Phosphate, Potassium Phosphate, Sulfate of Potash, Iron EDTA, Magnesium Sulfate, Manganese Sulfate, and Sodium Molybdate.

Item #	Formula	Price (\$) 1-19 Bags	Price (\$) 20+ Bags
49439	17-6-12	60.50	56.75

17-6-12 with Minors (5-6 Month Release*/NPK with Micronutrients)

Guaranteed Analysis	
Total Nitrogen (N)	17.0000% (8.1730% Nitrate Nitrogen, 8.8270% Ammoniacal Nitrogen)
Available Phosphate (P ₂ O ₅)	6.0000%
Soluble Potash (K ₂ O)	12.0000%
Magnesium (Mg)	0.6450% (0.6540% water soluble Magnesium)
Iron (Fe)	0.1550% (0.1550% Chelated Iron)
Manganese (Mn)	0.0620% (0.0620% water soluble Manganese)
Molybdenum (Mo)	0.0050% (0.006% Chelated Zinc)

Derived From: Polymer Coated: Ammonium Nitrate, Ammonium Phosphate, Monoammonium Phosphate, Potassium Nitrate, Sulfate of Potash, Iron EDTA, Magnesium Sulfate, Manganese Sulfate, and Sodium Molybdate.

Item #	Formula	Price (\$) 1-19 Bags	Price (\$) 20+ Bags
49440	17-6-12 w/Minors	60.75	56.00

15-6-12 with Minors (8-9 Month Release*/NPK with Micronutrients)

Guaranteed Analysis	
Total Nitrogen (N)	15.0000% (6.7500% Nitrate Nitrogen, 8.2500% Ammoniacal Nitrogen)
Available Phosphate (P ₂ O ₅)	6.0000%
Soluble Potash (K ₂ O)	12.0000%
Magnesium (Mg)	1.3000% (1.3000% water soluble Magnesium)
Sulfur	6.3000% (6.3000% combined Sulphur)
Copper (Cu)	0.0760% (0.0760% water soluble Copper)
Iron (Fe)	0.3200% (0.3200% Chelated Iron)
Manganese (Mn)	0.1300% (0.1300% water soluble Manganese)
Molybdenum (Mo)	0.0110%
Zinc (Zn)	0.0760% (0.0760% water soluble Zinc)

Derived From: Polymer Coated: Ammonium Nitrate, Monoammonium Phosphate, Sulfate of Potash, Copper Sulfate, Iron EDTA, Magnesium Sulfate, Manganese Sulfate, Sodium Molybdate, and Zinc Sulfate.

Item #	Formula	Price (\$) 1-19 Bags	Price (\$) 20+ Bags
49441	15-6-12 w/Minors	62.00	58.25

*Release is based on a constant temperature of 86°F. In cooler environments, the product will take longer to release.



FERTIL™ TOPDRESSER ADJUSTABLE GRANULAR APPLICATOR



- Gravity feeds the granular material to the control wand and metered amount is dispensed with the simple press of a level
- Top-dress with doses up to 4 ½ teaspoons, up to 1,500 plants per hour
- Adjusts dosage from 2 to 25 grams fast

Item #	Description	Price (\$)
49726	Fertil Topdresser	530.00



FERTILIZERS

First in Fertilizers Since 1922!
Pages 44-45, 144



The best fertilizer is a gardener's shadow.



WATERWORKS

Uses 25-32% Less Soil – Saves Money!

WaterWorks crystals act like a super absorbent sponge capable of absorbing and holding 400 to 500 times their weight in water. By mixing WaterWorks into the soil, it “time releases” the perfect amount of water to any type of plant, tree, or garden for weeks in between watering intervals. The plants’ roots seek a water source and grow into the hydrated WaterWorks, taking water to the plant by osmosis. Your plants receive water “On Demand” even if you forget to water.

- WaterWorks keeps the root zone moist, not wet, providing for better germination and aeration, which allows a plant to grow from 8% to 25% faster while reducing watering intervals by more than 75%
- WaterWorks is 100% non-toxic and is designed to work well with any water soluble plant food, fertilizer or soil mix
- Once WaterWorks enters the soil, it expands within minutes of the first watering for fast results
- Plants will take in (through osmosis) water, fertilizer or fungicide from the WaterWorks crystals
- WaterWorks crystals will expand and contract as they take in water, then releases it to the plant, improving aeration and porosity in the soil mix
- WaterWorks will not make the soil wet
- One treatment continues to work in the soil for up to 5 years!

Item #	Description	Price (\$) 1-19	Price (\$) 20+
45948	55 lbs, SP-400	242.25	226.25
45949	50 lbs, Ag Grade	260.00	243.75

Gloeckner Cares!



BIOBLENDER MEDIA MIX

BioBlender Media Mix helps improve the health of the plant by maintaining a healthy population of beneficial soil microorganisms that crowd out unwanted populations. BioBlender contains beneficial *Bacillus Subtilis* GB03 bacteria that will quickly colonize the root surface improving nutrient uptake, stimulate new and more vigorous root growth, and protect roots from stress.

- Combines all of the benefits of the Companion and Essential biostimulant
- Maintains a healthy population of beneficial soil microorganisms that crowd out the unwanted pathogens
- Contains Humic Acid that will increase the CEC of soils and replenish organic matter
- Contains a safe and natural wetting agent and a natural biostimulant that enhances root formation and branching

Item #	Description	Price (\$)
49717	5 lb E-Z pail	80.25
49718	20 lb E-Z pail	309.00
49719	40 lb E-Z pail	560.00



TKO PHOSPHITE 0-29-26

TKO Phosphite 0-29-26 is a clear, highly concentrated P/K solution containing mono- and di-potassium salts of Phosphorous Acid. The Phosphite in TKO is more soluble than Phosphate and absorbs rapidly into plant tissue through leaves and roots with excellent movement in both Xylem and Phloem.

- Translocation in Phloem allows TKO to move from leaf tissues to the branches, crowns, and roots, because of this property: Phosphonates improve the plants resistance by stimulation of natural host defenses
- Phosphites have greater solubility and are more readily available to microorganisms and plant roots than Phosphates
- TKO provides stimulation to plants to make a broad spectrum of biologically active metabolites, not occurring with Phosphates
- TKO can be used on all crops including but not limited to leafy vegetables, legumes, tubers, fruit, and nut trees.

Item #	Description	Price (\$)
49720	2 x 2.5 gallon	180.25



pH REDUCER CITRIC ACID SOLUTION

The pH Reducer is a safe alternative to Phosphoric and Sulfuric Acid.

- Lowers the pH of soilless media and water or as a buffer in the mixing tank
- Extra benefit of chelating micronutrients that may be unavailable in the soil
- Contains a natural wetting agent to help the Citric Acid penetrate the soil quickly

Item #	Description	Price (\$)
46509	2 x 2.5 gallon	88.50



ESSENTIAL PLUS 1-0-1

Essential Plus is a 100% natural organic product derived from Potassium Humate, 21 natural L-amino acids, enzymes, simple and complex sugars, vitamins, kelp extracts, carbohydrates, cellulose, lignin, hydrolyzed organic proteins, and a natural wetting agent. Essential Plus is ideal for use at plug production to ensure seed germination and good rooting.

- Provides a safe alternative to chemical hormones; 100% organic and is classified safe for the applicator and environment
- Eliminates transplant shock and provides better establishment when used at plug production
- Adds organic matter to depleted soils reducing the effects of compaction, improving water penetration and nutrient holding capacity
- Provides important food source for beneficial soil microbes
- Corrects soil alkalinity and reduces and neutralizes salts in high salt soils
- Active Humic Acid retains nutrient ions from leaching through soils and holds them in a form readily available for plant uptake

Item #	Description	Price (\$)
48959	4 x 1 gallon	238.75
48960	2 x 2.5 gallon	295.50





CHRYSALESCO FOLIAR SPRAY



Chrysal Alesco is a post-harvest product developed primarily to protect ethylene sensitive crops during shipping and retail storage. Specifically, Alesco reduces flower pedal shatter, bud abortion, and leaf yellowing extending the life of the flowers.

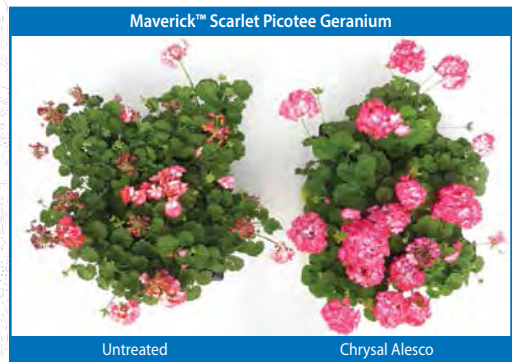

- Increases shelf-life up to 3 weeks depending on conditions
- Highly effective on ethylene sensitive crops such as Campanula, Dahlia, Dianthus, Hibiscus, New Guinea Impatiens, Lobelia, Pansy, Pelargonium, Petunia, Rose, Schlumbergera, and Viola
- Active ingredient is Silver Nitrate; EPA registration number is 72992-1

Item #	Description	Price (\$) 1-5	Price (\$) 6+
51921	200 ml bottle*	93.00	85.00

*1 ml per liter for spray application.



SOAX® WETTING AGENT



Soax® wetting agent helps to improve consistency, quality and efficiency of commercial growing media during crop production and beyond.

- Increased “feeding” sites for plant roots due to the uniform moisture profile
- Helps to reduce water pockets and dry patches in the growing media
- Even air-to-water ratios throughout root zone, promoting vigorous growth
- Helps reduce labor costs by eliminating the need for spot watering

Item #	Mfr #	Description	Case Pk	Price (\$)
46468	5900	Liquid 1 gallon jug	4 jugs	285.87
45301	5905	Liquid 5 gallon pail	1 pail	329.60
45302	5930	Liquid 55 gallon drum	1 drum	2,060.00
45303	5936	Granular 120 lb drum	1 drum	385.07



ETHYLBLOC™ ETHYLENE INHIBITOR



EthyBloc™ Technology is an EPA approved ethylene action inhibitor. It inhibits the negative effects of ethylene which include: premature wilting, leaf yellowing, premature opening, and premature death. EthyBloc™ is a registered trademark of the Dow AgroSciences Company and is not for use on food or food crops.

- EthyBloc™ works naturally with flowers and plants to keep them fresh from the field during shipping and distribution right through to the consumer
- It can be used with cut flowers, potted flowers, bedding, nursery, and foliage plants
- Increases flower life by up to 300%
- Effective in both refrigerated and room temperature conditions
- Easy to use, nontoxic, and safe for workers

Item #	Mfr #	Description	Case Pk	Price (\$)
48134	81-09038	Transportation Kit	38 grams	100.00
48135	81-09075	Transportation Kit	75 grams	180.00
48136	81-09600	2.5 gm sachets	1000/pk Cs	246.67



HORTUS IBA WATER SOLUBLE SALTS™



- Registered with the US EPS for use in greenhouses and nurseries
- Water soluble IBA requires no alcohol to dissolve
- Economical and easy to use – measure and mix
- Can be used by basal dip, and foliar total immerse or spray drip down methods
- Approved label under WPS for zero-hour re-entry Interval
- Used by professional growers
- Propagate new plants from cuttings
- Fully soluble to 60,000 PPM+ using only water
- The Salts are fully water-soluble to over 60,000 ppm IBA and do not require buffering

Item #	Description	Price (\$) 1-4 Kg	Price (\$) 5+ Kg
46507	20% IBA, 2.2 lbs (1 Kg)	395.00	365.00

Easy-to-use methods save you time and money!

Quick Dip Method: Dip the basal end of the cutting into the solution, then plant	Total Immerse Method: Immerse cutting into solution a few seconds, then plant
Spray Drip Down Method: Plant the cutting then spray until drip down	Immerse Soak Method: Dip basal end in solution a few hours then plant; for difficult-to-root cuttings



RHIZOPON™ (Powder Rooting Hormones) AA #1, #2 & #3



- Registered with the US EPS for use in greenhouses and nurseries
- Acts with the plant's own natural rooting hormones to aid in root formation by uniform absorption of the active ingredient
- Ready and economical to use; Color coded for easy identification
- Used by the Dry Dip Method
- Approved label under WPS for zero-hour re-entry Interval

Item #	Description	Price (\$)
41474	#1 Powder, pink, .1% IBA, 1 lb	24.75
41475	#2 Powder, green, 3% IBA, 1 lb	27.50
41476	#3 Powder, white-gray, .8% IBA, 1 lb	45.75
Water Soluble Tablets		
41479	200 pack	105.00
44428	2500 pack	566.25



SUSTAINABLE SOLUTIONS FOR GREENHOUSE AND NURSERY CROPS

For many years, BioSafe Systems has been dedicated to providing chemistries to all facets of a greenhouse or nursery, from propagation to finished production. The philosophy centers around our mission to provide comprehensive horticultural solutions for plant health and quality.

ZeroTol 2.0

ZeroTol 2.0 is a contact broad spectrum bactericide/fungicide proven to reduce disease pressure and increase crop health and vigor.

- Foliar spray, drench, mist or direct inject
- No mutational resistance
- Can be tank mixed
- Zero Hour REI



Active Ingredients: Hydrogen Dioxide and Peroxyacetic Acid

Item #	Size	Price (\$)
48991	2.5 gallon	129.75
48992	30 gallon	1,362.00
48993	55 gallon	2,219.64
48994	275 gallon	9,291.75

OxiPhos

OxiPhos is a systemic and contact bactericide/fungicide that is proven to reduce Downy Mildew, Pythium, and Phytophthora.

- Works systemically & on contact
- Activates plant's defense mechanisms
- Apply as a foliar spray, drench, or dip
- Can be tank mixed



Active Ingredients: Phosphoric Acid and Hydrogen Dioxide

Item #	Size	Price (\$)
49003	2.5 gallon	93.50
49004	5 gallon	176.50
49005	30 gallon	973.25
49006	55 gallon	1632.25
49007	275 gallon	6637.75

Note: All 275 gallon units shipped pre-paid freight.

AzaGuard

AzaGuard is an organic insecticide with multiple modes of action.

- Insect growth regulator, anti-feedant, insect repellent, and ovi-position deterrent
- Effective on over 300 insect species
- Can be tank mixed
- Can be used on all crops included ornamentals, fruits, vegetables, and herbs



OMRI Listed
Active Ingredients: Azadirachtin

Item #	Size	Price (\$)
48995	32 oz	141.95
48996	1 gallon	539.75

CaIOx

CaIOx is a high quality, finely micronized calcium that can be absorbed by leaves and roots and promotes stronger plant cell walls and reduces plant stress.

- Available in two forms; liquid or dry
- Does not clog nozzles
- Quickly and easily corrects calcium deficiencies
- Supplies additional calcium to food crops



Active Ingredients: Calcium Carbonate

Item #	Size	Price (\$)
49008	2.5 gallon	68.50
49009	5 gallon	120.50
49010	30 gallon	691.50
49011	55 gallon	1,231.50
49012	275 gallon	5,270.50



Available Upon Request.



PROTILIZER® SEED & PLANT ACTIVATOR

Grows Strong Roots & Reduces Plant Loss!

Protitizer Seed & Plant Activator is rich in humic acid, kelp, mycorrhizae fungi, and billions of proprietary beneficial microbes.

- Microbe powerhouses surround the roots to drastically reduce shock
- Within 24 hours, plants roots are absorbing nutrients in a healthier soil environment with fewer pathogens
- 100% organic and OMRI® listed



"Babikow Growers in Maryland just cut six weeks off their growing time of Epimedium using Protitizer."

Item #	Mfr #	Description	Price (\$)
50023	30605	4 lb jug (covers 1 1/2 acres)	101.50
50024	30600	27 lb pail (covers 10 acres)	648.00
51874	60000	48, 1/2 oz packets, counter top	94.25
51875	60010	8 x 6 oz container	96.00



ORGANIC 5-5-5

With Phosphorus & Mycorrhizae for Strong Roots!

Natural Alternative 5-5-5 works with nature – not against it, using the right combination of beneficial bacteria, mycorrhizae fungi, organic nutrients, iron, and sulfur. Moreover, contains Protitizer with its billions of colony forming units (CFUs) derived from various beneficial soil bacteria such as:

- Bacillus: Produces anti-fungal agents to fight pathogenic fungi
- Pseudomonas: Produces plant growth hormones naturally to increase root density
- Streptomyces: Solubilizes phosphorous for root initiation in new plants and increased seed germination
- Trichoderma: Solubilizes phosphorous for root initiation in new plants and growth



Item #	Mfr #	Description	Price (\$)
50022	30555	50 lb bag (covers 20,000 sq ft)	49.99
51876	55500	6 x 6.5 lb jug case	66.75
51877	11555	48 x 6.5 lb jug (pallet)	467.50



**ROOTSHIELD®
BIOLOGICAL FUNGICIDES**

Within 24 hours, blocks and actively attacks pathogens by “eating” them, ensuring uninterrupted plant growth • Active ingredient is a hybrid fungus *Trichoderma Harzanium*, strain T-22 that protects roots from many pathogens • Controls *Pythium*, *Fusarium*, *Rhizoctonia*, *Thielaviopsis*, and *Cylindrocladium* • Releases enzymes that dissolve the cell wall of many fungal pathogens • Reduces or eliminates chemical fungicide applications • 0-hour REI



Item #	Size	Price (\$)
RootShield WP		
49471	3 lb	236.95
49472	30 lb	Call for Price
RootShield Granules		
49465	40 lb	425.00

**ROOTSHIELD® PLUS
BIOLOGICAL FUNGICIDES**

Next generation Rootshield now prevents soilborne *Phytophthora*, and improved control of hot season *Pythium* (*P. aphanidermatum*) • Also controls *Pythium*, *Fusarium*, *Rhizoctonia*, *Thielaviopsis*, and *Cylindrocladium* • One application provides up to 12 weeks of protection • Promotes a healthier root system, increasing root mass • Grows on roots, “shielding” them against root-damaging fungi



Item #	Size	Price (\$)
RootShield Plus WP		
49478	1 lb	130.25
49479	3 lb	272.25
49480	30 lb	Call for Price
RootShield Plus Granules		
49482	40 lb	500.00

BOTANIGARD® MYCOINSECTICIDE

An effective biological insecticide that is used to control whitefly, thrips, aphids, and many other insects. It is based on the highly successful fungus, *Beauveria bassiana* strain GHA, and controls the most troublesome crop pests – even resistant strains such as Q-biotype whitefly.

- Versatile enough to use as a standalone, as a tank mix partner, or in rotation with other insecticides
- Superior formulation – highest spore concentration in a *Beauveria*-containing insecticide
- Equals or exceeds chemical insecticides
- Unique mode of action – spores infect directly through the insect’s cuticle
- Controls the early stages of insects, preventing population flare-ups and the cost of rescue treatments
- Excellent safety profile – reduces risk to workers and the environment
- Exempt from residue tolerance and has a 0-day preharvest interval
- 4-hour REI



Item #	Formulation	Size	Pest	Rate	Price (\$)
49468	BotaniGard® ES	1 qt	Whiteflies, mealybugs, aphids	½ qt to 1 qt/100 gallons	78.75
49467		1 gallon	Thrips Other labeled insects	1 qt to 2 qt/100 gallons ½ qt to 2 qt/100 gallons*	
49463	BotaniGard® 22WP	1 lb	Whiteflies, mealybugs, aphids	½ lb to 1 lb/100 gallons	78.25
			Thrips	1 lb to 2 lb/100 gallons	
			Other labeled insects	½ lb to 2 lb/100 gallons*	
			Interiorscape bed rates	¼ to 1 tsp/gal/10 sq ft	

*Rate depends on insect population and foliage density. **Mycotrol O is OMRI listed.

CEASE® MICROBIAL FUNGICIDE/BACTERICIDE

Cease® provides effective control of a wide array of both fungal and bacterial pathogens, while providing outstanding plant, human and environmental safety. Based on a naturally occurring, patented strain of *Bacillus subtilis* (strain QST 713).

- Effective alternative to synthetic chemicals for fungal pathogens
- Broad spectrum root biofungicide for the prevention, suppression and control of soil borne diseases on a wide range of ornamentals and vegetables
- Proven efficacy against BOTH fungal and bacterial pathogens
- Excellent safety – only a 4-hour REI, and can be sprayed up to and on the day of harvest
- Performs as well as copper-based products, without phytotoxicity or residues
- OMRI listed and NOP-approved for use in organic production
- Excellent for sustainability for IPM programs
- Compatible for tank-mixing/rotating with other registered products



Item #	Size	Price (\$)
49473	1 gallon	59.50

MILSTOP® WATER SOLUBLE BROAD SPECTRUM FOLIAR FUNGICIDE

Choose MilStop for curative control of powdery mildews and preventative control of most other foliar diseases. There is no known resistance to MilStop; an excellent disease management tool as a standalone fungicide for foliar disease control or alternated as part of an integrated pest management program.

- Kills powdery mildew on contact and provides 1 to 2 weeks of residual protection
- Effective on interiorscape, greenhouse, nursery, woody, herb and field crops
- Cost effective; comes pre-formulated with surfactants
- 1-hour REI; OMRI Listed and is compatible with many beneficial insects
- Active ingredient approved by the FDA as G.R.A.S. (Generally Regarded As Safe)



Item #	Size	Price (\$)
49466	5 lb bag	56.25

*Sweet flowers are slow and weeds make haste.
~Shakespeare*



NEMASHIELD® BIOLOGICAL CONTROL FOR FUNGUS GNATS AND WESTERN FLOWER THRIPS



NemaShield® is the ideal choice for safe, effective control of Fungus Gnats and Western Flower Thrips. A single application of NemaShield, containing the beneficial nematode *Steinernema feltiae*, is sufficient for preventing Fungus Gnat outbreaks or control in the beginning phase of an outbreak.

- Fast, effective biological control of Fungus Gnat larvae and WFT pre-pupae and pupae in the growing medium
- Easy and safe to apply
- Exempt from EPA regulations; 0-hour REI
- Compatible with many pesticides
- Easy-to-use dispersible formulation

Item #	Active Units	Price (\$)
49469	100 million	78.50
49470	500 million	215.00
49475	2 billion	Call for Price



SUFFOIL-X® SPRAY OIL EMULSION INSECTICIDE, MITICIDE, FUNGICIDE



SuffOil-X® is a unique concentrate of pre-emulsified, highly refined, high paraffinic, low aromatic oil. It is the ideal choice for effective insect, mite and disease control in a broad range of greenhouse, nursery and vegetable crops.

- Provides uniform coverage to suffocate pests without causing stress to plants
- Works well in high or low pressure spray applications
- Excellent compatibility with pesticides labeled for use with oil
- Does not require rigorous agitation to maintain homogenous mix and stay in suspension
- 4-hour REI; OMRI listed
- Poses few risks to people and many beneficial insects, allowing it to integrate well with biological controls

Item #	Size	Price (\$)
49476	2.5 gal.	57.50
49477	30 gal.	548.75



MOLT-X® BOTANICAL INSECTICIDE/ NEMATICIDE



Molt-X works primarily as an Insect Growth Regulator (IGR) that disrupts the molting process in insects. Insects treated with Molt-X become sluggish, stop feeding, and fail to mature and reproduce. Molt-X also acts as an insect repellent, antifeedant, and ovipositional deterrent. Molt-X is an emulsifiable concentrate formulation containing 3% of the active ingredient azadirachtin – the most potent of the insect-active compounds from the neem tree.

- Leaves no residue on plant foliage, fruits, vegetables or flowers
- 4-hr REI and a zero-day pre-harvest interval mean little interruption
- Compatible with most commonly used insecticides, fungicides and fertilizers
- No phytotoxicity issues on most plants
- Compatible for tank mixing/rotation with other registered inputs
- Provides broad-spectrum control, including pests such as: Aphids, Whiteflies, Thrips, Fungus Gnats, Leafhoppers, Leafminers, Leafrollers, Sawflies, Webworms, Mealybugs, Scales, Plant-Parasitic Nematodes, Cutworms, and Webworms

Item #	Size	Price (\$)
49474	1 qt	197.50

Molt-X is OMRI listed.



COMPANION® BIOLOGICAL FUNGICIDE



Companion Biological Fungicide is a broad spectrum biological fungicide developed for the prevention, control, and suppression of soil borne and foliar diseases on all agricultural crops. Ideal for use on all outdoor field grown crops including vegetables, herbs, small fruits, berries, fruit, and nut trees.

- Contains the active ingredient Bacillus Subtilis GB03 which is a Rhizosphere bacteria that quickly establishes beneficial colonies on the plants roots and leaves
- Stimulates healthier roots, accelerates plant growth, and activates the defense system of the plant
- Non-selective Companion is most effective when applied prior to the onset of disease

Item #	Size	Price (\$)
44336	1 gallon	118.75
44334	2.5 gallon	272.50
44335	5 gallon	481.00



PESTRAP™ PEST CONTROL PRODUCTS

Pestrap products are proven to be a safe and effective method of pest control in greenhouses – and at an affordable price.

Pestrap Medium

Essential IPM Tool • Grids for estimating threshold levels • One card for every 500 sq ft of greenhouse • Non-toxic and extremely sticky adhesive • Use of gloves recommended

Item #	Description	Pack	Price (\$) 1-11	Price (\$) 12+
49014	4" x 10" Yellow	12/Pk	15.50	12.00
49015	4" x 10" Blue, Thrips	12/Pk	15.50	12.00
49016	4" x 10" Yellow/Blue	12/Pk	15.50	12.00

Pestrap Jumbo

Essential IPM Tool • Helps reduce pest populations • Non-toxic and extremely sticky adhesive • One card for every 6 linear foot of bench space • Use of gloves recommended

Item #	Description	Pack	Price (\$) 1-11	Price (\$) 12+
49017	10" x 16" Yellow	12/Pk	52.50	39.50

Pestrap Cards

Moisture-resistant, long-lasting monitoring cards • 1" grids for easy reading and accurate monitoring counts

Item #	Description	Pack	Price (\$) 1-11	Price (\$) 12+
49020	3" x 5" Yellow	48/Pk	23.30	17.75
49022	3" x 5" Yellow/Blue	48/Pk	23.30	17.75

B-NINE®

Water soluble granule plant growth regulator reduces plant stature by reducing internode length. Works on a wide variety of ornamentals, including chrysanthemums, gardenias, azaleas, hydrangea and poinsettias, along with petunias, marigolds and other flowering and foliage plant species.



- Promotes compact, deeper green foliage
- Reduces apical dominance (the tendency of shoots to grow without branching) – treated shoots form terminal buds early and then branch out profusely, giving treated plants a compact habit of growth and increasing flower bud formation
- Treated plants have a more branched root system, providing firmer anchorage and better nutrient and moisture extracting capability
- Treated plants are less likely to wilt and also recover more quickly from the stress of transplanting

Item #	Size	Price (\$)
47308	1 lb bag, each	63.00
47309	5 lb bag	268.25

BONZI™

Plant growth regulator for use on container-grown flower and bedding plants in greenhouses and shade houses.



- Use of Bonzi effectively reduces internode elongation, resulting in more desirable compact plants
- When used as directed, Bonzi produces no phytotoxic effects
- Desired height control may be obtained with a single Bonzi spray or drench application

Item #	Size	Price (\$)
45388	1 quart, each	133.75

Sequential applications may be desirable under certain conditions. Different species and cultivars vary in their rate response to Bonzi. Short, slow growing cultivars require a lower rate than tall, fast growing types.

CONCISE® GROWTH REGULATOR

Concise has been developed for denser plants with more compact growth, darker green foliage, and longer shelf-life. Concise is an effective growth retardant for use on a wide variety of ornamental plants.

- Reduces plant height by limiting internode elongation, resulting in more desirable, compact plants.
- Concise has been shown to increase the quality of plants, despite noticeable growth reductions
- Active ingredient: 0.055% Uniconazole-p

Item #	Size	Price (\$)
49749	1 gallon	302.50



CYCOCEL

Reduce stem elongation for stronger stems and greener leaves.

- AZALEAS – Foliar spray (2-3 oz of Cycocel per gal of water) in July when regrowth is ¾" to 1" long following pinching. Repeat 1 week later. Will usually give multiple buds. Cycocel will usually stop all growth soon after spraying. Cycocel on Pericat varieties will sometimes give leaf injury.
- RED POINSETTIAS – Plants should be well rooted and established in container before treatment. Most effective response when treatment is made during period of active root growth. Do not apply later than October 15 in north and November 1 in south.
- SEED GERANIUMS – Plants should be at the 4-5 leaf stage, about 35 days after sowing. Repeat applications one week later. (1 ¾" oz Cycocel/gal water). Root area should be moist and foliage dry. Do not water plants for 24 hours after application.

Item #	Size	Price (\$)
45391	1 quart, each	57.75
45364	1 gallon, each	158.50

FASCINATION

Fascination® is a combination of two types of plant growth hormones that produce unique and dramatic effects in plants. The initial label includes applications to Easter, LA Hybrid, and Asiatic lilies.



- Lower leaf yellowing, a significant problem late in the lily crop can be prevented by two applications of Fascination® at 5-10 ppm 1 week before and after the projected visible bud date
- A third application when the largest buds are 3" long at 100 ppm causes the lily blooms to stay open up to 24 days, and eliminates the lower leaf yellowing that can occur during cooler storage

Item #	Size	Price (\$)
45316	½ gallon	479.50



FLOREL

A preparation of Ethrel. Recommended for setting flowers in Bromeliads. Research indicates its added value in stimulating the branching of Geraniums, Azaleas and Roses. Check with your local agricultural representative for more information on the use of this material for purposes not on the label.



Item #	Size	Price (\$)
45394	1 quart, each	25.00
45367	1 gallon, each	50.25

PICCOLO PGR (Paclobutrazol)

Generic equivalent for Bonzi PGR

Piccolo offers control of height and radius across a wide range of ornamental crops. Piccolo enhances the quality of bedding plants, flowering and foliage plants, bulb crops, perennials, and woody ornamentals, making them easier to market and more profitable to produce. Piccolo has given excellent results with leading growers and has been proven in extensive university research trials.



Item #	Size	Price (\$)
45370	1 gallon	173.25

PROGIBB T&O 4% (Gibberillic Acid)

Plant growth regulator used for stem elongation, plant substitution for cold treatment and to hasten flowering in certain plants. Use on azaleas, chrysanthemums, cyclamen, fuschia, geranium, hydrangea and others. Rates vary widely depending on the application.



Item #	Size	Price (\$)
47017	1 quart	60.75

SUMAGIC

Through stem and root uptake, Sumagic regulates the growth hormone that stimulates stem elongation, resulting in more attractive, compact and lush plants.



- Use on a wide variety of floriculture and landscape crops, from bedding to container-grown plants
- No detrimental effects on leaf color, leaf size or shape
- Fewer applications and lower rates
- Broad label enables you to treat more types of plants with one product

Item #	Size	Price (\$)
45375	1 gallon	359.50

ACTINOVATE® SP BIOLOGICAL FUNGUS CONTROL *New Listing!*

Actinovate SP suppresses and controls soil-borne plant diseases such as *Pythium*, *Rhizoctonia*, *Phytophthora*, and *Fusarium* when applied as instructed. In addition, Actinovate AP suppresses and controls foliar diseases such as *powdery mildew* and *Botrytis* when applied as instructed.



- Formulation is 100% soluble and will not clog machinery
- Active ingredient is *Streptomyces Lydicus* WYEC 108* – 00.0371%

Item #	Size	Price (\$)
48138	10 oz (510 gm)	108.00

*End-use product contains not less than 1×10^2 CFU/g *Streptomyces Lydicus* WYEC 108.

BANROT 40WP

Wettable powder systemic broad-spectrum fungicide prevents and controls most damping-off, root and stem rot diseases of nursery and ornamental crops caused by soil-borne fungi.



Controls: *Pythium*, *phytophthora*, *rhizoctonia*, *thielaviopsis*, *cylindrocladium*, *sclerotinia*, and *fusarium*.

Item #	Size	Price (\$)
45326	2 lb	71.75

CAMELOT® O FUNGICIDE & BACTERICIDE *New Listing!*

For organic production. Camelot O is a liquid copper formulation for broad spectrum control of listed fungal and bacterial diseases. Ideally suited to target Anthracnose Black Spot Dollar Spot Leaf Spots Powdery Mildew from developing on plant surfaces.



- Easy to measure and use flowable copper soap formulation
- Ideal for greenhouse herb/vegetable crops, shadehouse and turfgrass
- Active ingredient is Copper Octanoate – 10%

Item #	Size	Price (\$)
47346	1 gallon	111.25

CHIPCO 26019 WP

A broad spectrum fungicide that may be applied safely to a wide range of ornamental flowering and foliage plants.



Controls: Aerial web blight, *alternaria* leaf blight, *alteranria* leaf spot, *botrytis* blight, *fusarium* leaf spot, *helminthosporium* leaf spot, *rhizoctonia* stem and root rot, ink spot, tulip fire Ray Blight, *fusarium* corm rot, daffodil leaf scorch, blossom blight, *botyitis* storage rot, *cylindrocladium* blight and wilt.

Item #	Size	Price (\$)
45327	2 lb	108.50

CLEARY 3336-F

A flowable ornamental and turf fungicide for use on bedding plants, ornamentals, and roses in greenhouses, and for flowers, turf, and shade trees in the field.



Controls: *Botrytis*, *fusarium*, *rhizoctonia*, *sclerotinia*, rots, and *thielaviopsis* as a drench; and controls *botrytis* and powdery mildew as a Foliar Spray.

Item #	Size	Price (\$)
45389	1 quart	54.00
45363	1 gallon	294.50

DECREE 50 WDG

Active Ingredient: Fenhexamid
Decree provides long residual control of *Botrytis* with minimal visible residue and excellent plant and bloom safety. Several edible crops are on the label.



Rate: 1 - 1 1/2 tsp/gal or .75-1.5 lbs/100gal.

Item #	Size	Price (\$)
45310	2.5 lb	328.50

EAGLE 20 EW

Active Ingredient: Myclobutanil
Foliar fungicide for the control of powdery mildew, rust, scab and other diseases. Can be used on ornamentals outdoors and in greenhouses, along with some fruit trees and vine crops. Eagle is locally systemic, with curative and protectant activity.



Rates: 1/2 - 3/4 tsp/gal or 6-12 oz/100gal.

Item #	Size	Price (\$)
45382	1 pint	34.00
45366	1 gallon	183.50

HERITAGE

Strobiluron fungicide labeled for use as a foliar spray, and drenches on ornamentals in greenhouses, container, or fieldgrown crops and other locations. Broad-spectrum residual control.



Controls: Many diseases including *alternaria*, *botrytis*, *cercospora*, downy mildew, powdery mildew, and scab.
Rates: Foliar spray – 1 to 4 oz/100 gallon; drench – .2 to .9 oz/100 gallon.

Item #	Size	Price (\$)
45339	4 oz	112.75

PROPI-STAR™ EC *New Listing!*

Propi-Star EC can be successfully used to control fungus in *Hydrangea*, *Lilium Longiflorum*, and other plants. In addition to fungus control, pleasant side effects have occurred in trials such as height control and giving a nice “finishing touch” to the plant.



Active Ingredient Propistar/Propiconazole T & O 41.8%: Propiconazole is a triazole fungicide that has protective, curative, and systemic activity.

Item #	Size	Price (\$)
50028	1 gallon	110.00

**Need Personal Assistance?
Call 800-345-3787**

PHYTON-35

A fully systemic, copper-based bactericide and fungicide for use on begonias, cyclamen, geraniums, New Guinea impatiens, poinsettias, roses, and azaleas and rhododendron. Also effective on fruits, vegetables, and herbs.

Controls: Botrytis, bacterial diseases, black spot, cylindrocladium, and powdery mildew.



Item #	Size	Price (\$)
48876	1 liter	140.00
48877	1 gallon	266.50

SUBDUE MAXX

The only fungicide in the ornamental industry with a revolutionary microemulsion formulation designed to maximize Pythium and Phytophthora control.

- Offers the same superior control of Pythium blight you've come to depend on from Subdue EC, but at half the use rate
- Offers ease in mixing and reduces equipment wear
- Has a zero hour reentry



Item #	Size	Price (\$)
45400	1 quart	193.50
45374	1 gallon	643.75

TRUBAN 30% WP

- Has been proven the most effective fungicide for control of damping off, root and stem rot diseases caused by Pythium and Phytophthora

- May be used at the time of seeding and transplanting as either a soil mix or as a drench



Item #	Size	Price (\$)
45329	2 lb	82.75

TRUBAN 25% EC

Especially formulated for application through auto-matic watering and proportioning systems.

Controls: Damping-off, root and stem rot diseases of ornamental plants.

Item #	Size	Price (\$)
45403	1 quart	71.75



ADEPT 25 WP

Insect growth regulator provides effective control of fungus gnat and shorefly larvae for 30 days. Applied as a soil drench or as a coarse spray to the soil surface. Not for use on poinsettias.

Drench rate: 1 oz/100 gal water. Drench volume determined by pt size – chart is included on the label.



Item #	Size	Price (\$)
45309	1 lb pouch (16 water soluble 1 oz bags)	204.25

AKARI SC

Miticide allows for use on greenhouse ornamentals as well as interiorscapes, and now labeled for broad mites and cyclamen mites.

- 21-28 days of residual contact control.
- Mite feeding stops within a day and control can be evaluated 4 to 7 days after treatment
- No visible residue

Rate: ¼ - 1 ½ tsp/gal, or 12-24 oz/100 gal.



Item #	Size	Price (\$)
45384	1 quart	141.50

AVID

The number one insecticide used by growers for mites and leafminers on ornamentals.

- Its reputation for quality control also makes it the miticide/insecticide of choice for nursery and landscape professionals
- Its unique chemistry and mode of action make it an ideal product for rotation in resistance management programs

Controls: Mites, leafminers, aphids, thrips, and whiteflies.



Item #	Size	Price (\$)
45358	8 oz bottle	106.00
47307	1 quart	226.50

AZATIN

Active Ingredient: Azadirachtin

Botanical (neem) insect growth regulator. Halts growth process on instar and pupal stages of labeled insects. Labeled for vegetables and herbs. May be applied up to and on the day of harvest.

Controls: whitefly, thrips, mealybugs, leafminer, fungus gnats, soft scale, and more. **Rate:** ¼ - 1 tsp/gal or 10-16 oz/100gal.



Item #	Size	Price (\$)
45387	1 quart	222.75

CAPSIL

Active Ingredient: Polyether Modified Polysiloxane

CapSil is a unique organosilicone surfactant that increases spray droplet coverage by breaking surface tension. Most pesticides perform better, and visible residue from wettable powders is noticeably reduced. Do not use with strobiluron fungicides, or with pesticides that already contain a surfactant. Research has shown that CapSil can be used to decrease water stress and hasten rooting in many unrooted cuttings.



Item #	Size	Price (\$)
45362	1 gallon	115.45

CONSERVE SC

- Complete control is generally achieved within one to three days – speed comparable to most synthetic insect pest control products and much faster than most traditional biologicals
- Provides up to two weeks of control

Controls: Several very important greenhouse insect pests including serpentine leafminers, beet armyworms, western flower thrips, and spider mites.



Item #	Size	Price (\$)
45390	1 quart	154.50

DECATHLON® 20 WP

Decathlon 20 WP is effective for broad spectrum control of crawling and flying insect pests on ornamental and nursery stock. Decathlon 20 WP will not stain or cause damage to any painted or varnished household surface, plastic, fabric or other surface where water applied alone causes no damage.



Item #	Size	Price (\$)
45317	.5 lb	96.25

DISTANCE 1 GR

Distance acts by interrupting larval growth and development of the target insects. It also affects reproductive behavior and maturation in adult insects.

Controls: Silverleaf whitefly, sweetpotato whitefly, greenhouse whitefly, fungus gnat, shore fly, black scale, California red scale, Florida wax scale, San Jose scale, snow scale, spotted tentiform leafminer, and aphid (suppression only).



Item #	Size	Price (\$)
45392	1 quart	302.50

ENDEAVOR

Insecticide with a new class of chemistry that safely eliminates sap-sucking aphids and whiteflies in greenhouses and nurseries with its unique mode of action. As the aphid begins to tap into a plant treated with Endeavor, its sucking mechanism is immediately and irreversibly paralyzed and can do no more damage, and the aphid dies within 2-4 days with no more harm to the plants or to beneficial insects or mites.



Item #	Size	Price (\$)
45353	6 x 2.5 oz pouch	196.75

FLORAMITE SC

Floramite is a selective miticide that provides outstanding control of a variety of mite pests on ornamental plants in greenhouse, shadehouse, nursery, field, landscape and interiorscape settings.



- Labeled for use on virtually all types of ornamental plants, including bedding plants, flowering plants, foliage plants, bulb crops, perennial plants and woody plants
- Produces quick knockdown through contact activity and long residual control of more than 21 days
- Effective on a variety of species of mites and all life stages of Tetranychidus spider mites
- Easy on predacious mites and beneficial insects, making it ideal for use in IPM and resistance management programs

Item #	Size	Price (\$)
48875	8 oz	100.75
45393	1 quart	339.25

GNATROL WDG

Gnatrol WDG is a biological larvacide, applied as a drench for fungus gnat larvae in greenhouses, interiorscapes and nurseries. It is OMRI listed for organic production and labeled for ornamental and vegetable crops as well as breeding areas on greenhouse floors. The new WDG formulation contains wettable dispersible granules that have a longer shelf life (2 years) and are easier to mix and apply than the previous liquid formulation.



Rate: Preventative or light to moderate infestations – 3.2-6.4 oz/100 gal; heavy infestations – 13-26 oz/100 gal. 3 times at weekly intervals.

Item #	Size	Price (\$)
45330	16 lb	468.75

LADA 2 F

Same Active Ingredient as Marathon and Merit 21.4% Imidacloprid

A liquid systemic insecticide used in turf, landscapes, fruit/nut trees, interiorscapes, vegetable transplants, outdoor nursery and greenhouse as foliar spray or soil drench.



Controls: Adelgids, aphids, fungus gnat larvae, beetles, grubs, lacebugs, leafhoppers, leafminers, mealybugs, psyllids, scale, thrips, weevils, whiteflies. **REI:** 12 hours.

Item #	Size	Price (\$)
47895	1 quart	32.00
47896	1 gallon	73.50

LUCID

Same Active Ingredient as Avid from Syngenta 2% or 0.15 lbs per gallon Abamectin

A liquid miticide and insecticide used in shadehouse, greenhouse, outdoor ornamentals and landscapes as a foliar spray.



Controls: Mites, leafminers, aphids, thrips, whiteflies. **Rate:** 4-8 oz/100 gal or ¼ - ½ tsp/gal. **REI:** 12 hours.

Item #	Size	Price (\$)
47897	1 quart	70.00

MARATHON 1% GRANULAR

Insect control for use on/in indoor and outdoor ornamentals grown in flats, benches or beds and for treatment of containerized ornamental plants in nurseries, and greenhouses. For outdoor ornamentals, make no more than one soil application per crop cycle, or once per year for crop having a production cycle of longer than one year.



- Provides a systemic control with tremendous residual action.
- Granular applications can be made by mechanical means, broadcast applicators, or by media mixing
- For use as a growing media – mix, incorporate 3 lbs of Marathon 1% Granular per cubic yard of growing media

Controls: Aphids, mealybugs, thrips, whiteflies.

Item #	Size	Price (\$)
45346	5 lb container	66.50

MARATHON II

For foliar insect control in ornamentals, fruit and nut trees and vegetable transplants for resale, in greenhouses, nurseries and interior landscapes.



Controls: Aphids, adult Japanese beetles, leafminers, mealybugs, thrips, whiteflies, and white grub larvae. **Rates:** 1.7 oz/100 gal for foliar applications and .45 to .60 oz/1000 sq ft for broadcast applications. 14 – 21 day residual.

Item #	Size	Price (\$)
45334	250 ml	112.00

MAVRIK AQUAFLOW

Insecticide combines broad-spectrum activity against insect and mite pests with outstanding phytotoxic safety to all ornamental plant species tested. For use on ornamental plants, trees, and shrubs.



- At low to medium use rates, controls aphids, thrips, whiteflies, leaffeeding caterpillars and other labeled pests at a cost less than or equal to current standard control agents
- The active ingredient fluvalinate is an amino acid derivative which combines pyrethroid-like activity with mite suppression or control (depending on rate used), believed to act as a contact poison by disrupting the central and peripheral nervous system of insects similar to photostable pyrethroid
- A water-base flowable formulation
- Poses a low risk of hazard to humans and other mammals

Item #	Size	Price (\$)
45395	1 quart	109.00

M-PEDE

Concentrated contact insecticide soap contains naturally occurring fatty acids effective on adult and immature stages of labeled insects on vegetables, greenhouse crops and ornamentals. A low toxicity commercial pesticide.



Controls: Whitefly, aphids, mealybugs, thrips, spider mites, and more. **Rate:** 1.25 - 2.5 oz/gal water.

Item #	Size	Price (\$)
45324	2.5 gallon	99.50

ORCAL® SLUG-FEST ALL WEATHER FORMULA



Slug-Fest containing 25% Metaldehyde is the only liquid sprayable slug and snail control in the world. Slug-Fest is highly efficacious as a slug and snail eradicator. This product is best applied right after it has rained when slugs or snails are most active. EPA Reg. No. 71096-4.

Item #	Size	Price (\$)
45373	1 gallon	71.75

OVERTURE 35 WSP

Active Ingredient: Pyridalyl

Overture is a new insecticide for thrips and caterpillars on ornamentals produced in commercial greenhouses only. Overture is not labeled for outdoor applications. For good translaminar movement in plant tissue, mix one 2 oz packet in 25 gallons of water and apply at 14-28 days, but do not apply more than 3 times per crop cycle or 6 times per year. Allow 3-6 days to evaluate thrips control. For good plant safety, Overture can also be applied through low volume application equipment at the rate of 4.0 oz per 10,000 sq ft.



Item #	Size	Price (\$)
47323	1 lb (8 x 2 oz)	136.50

PYLON

A miticide labeled for use on ornamental greenhouse crops, Pylon kills by disrupting the cell function of mites. Once applied, Pylon moves rapidly from the top of the leaf to the bottom, making it useful against mites feeding on the underside of the leaf, and offers both contact control and 21-27 days of residual control.



Controls: Most mite species including two-spotted spider mite, apple rust mite, broad mite, carmine spider mite, citrus bud mite, citrus rust mite, cyclamen mite, pear rust mite, and the pacific spider mite.
Rate: 2.6 - 5.2 fl oz/100 gal.

Item #	Size	Price (\$)
45356	1 pint	623.19

RYCAR® WHITEFLY AND APHID CONTROL

Not only is Rycar excellent for controlling whiteflies and aphids, it also has been proven effective on chili thrips, mealybugs, and leafhoppers. Rycar is the perfect alternative to traditional neonicotinoids and fits great into an IPM program looking to diversify spray rotations and reduce the risk of resistance.



- Immediate stop-feed
- Gentle for both beneficial insects as well as pollinators
- Significantly reduces viral transmission

Item #	Size	Price (\$)
49746	8 oz	209.23

SAFARI

Safari is labeled as a foliar spray or a drench for ornamentals grown in greenhouses, indoor and outdoor nurseries and residential sites.



- Highly systemic drench is taken up into even older woody foliage
- Drench applications remain effective for 6 weeks or more
- Excellent plant and bloom safety

Controls: Insects including aphids, fungus gnat larvae, leafminers, mealybugs, scale, thrips (suppression only), and whiteflies. **Rates:** Foliar sprays – ¼ - ½ tsp/gal (4-8 oz/100 gal); soil drenches – 12-24 oz/100 gal with 4 oz per 6" of being applied.

Item #	Size	Price (\$)
47398	12 oz	120.50
45337	3 lb	412.50

TRIACT-70 HORTICULTURAL SPRAY OIL

(clarified hydrophobic extract of Neem oil)



- Biorational 3-way pesticide works as a broad spectrum miticide, insecticide, and fungicide
- Approved for use on indoor and outdoor ornamental flowering plants, trees, shrubs, and foliage plants grown in nurseries, greenhouses, interiorscape, and commercial landscapes.
- Compatible with many commonly used pesticides

Controls: Blackspot on roses, powdery and downy mildews, anthracnose, rusts, leafspot, botrytis, needle rust, scab, flower/twig/tip blight, all stages of mites and the nymphs, the adults of broadmites and rust mites, aphids, whitefly, and thrips (suppression).

Item #	Size	Price (\$)
45332	2.5 gallon	187.54

TALSTAR® PROFESSIONAL

Labeled for use on termites, indoor/outdoor pest control, turf, landscape as well as greenhouse ornamentals. Talstar Professional is water-based, so it's non-irritating and contains no odorous or plant-damaging solvents.



Controls: Ants, aphids, fungus gnats, feeding caterpillars, spiders, leafminers, mealy bugs, whiteflies, citrus thrips, beet armyworms, leafrollers, spidermites, thrips, and many others on the label. **Rate:** 8-20 oz/100 gal.

Item #	Size	Price (\$)
45402	1 quart	40.25

TRISTAR

Active Ingredient: Acetamiprid

Translaminar systemic insecticide for use on greenhouse and outdoor ornamentals and certain vegetable transplants. Applied as a foliar spray, it provides 2-5 weeks control of aphids, leafhoppers, mealybugs, whiteflies, and more. The label has been expanded to include scale insects, caterpillars, and many other pests. Excellent plant safety including poinsettia bracts. New loose fill formulation is ideal for smaller volume applications.



Item #	Size	Price (\$)
48139	4 oz	30.00
47973	1 quart	193.25

SPREADER STICKER LATRON B-1956

Recommendations for use depend on the crop, the pest, the kind of spray equipment, volume, pressure and droplet size of the spray and the pesticide or mixture being used. As a general guide, 1-2 oz are used on moderately easy-to-wet plants, 2-4 oz on hard-to-wet plants, and 4-8 oz on very hard-to-wet plants per 100 gallons of dilute full-volume spray. As sprays are concentrated to 2X, 10X or 20X, the amount of Spreader Sticker should be increased in about the same proportion as the pesticide.



Item #	Size	Price (\$)
45368	1 gallon	54.00

BEETHOVEN® TR MITICIDE/INSECTICIDE

Featuring the active ingredient Etoxazole, Beethoven TR is a total release aerosol that controls mites, including the two-spotted spider mite and whiteflies. Beethoven TR is ideal for bedding plants, cut flowers, hanging baskets, foliage, potted plants, and ornamentals.

- Quick and easy application
- Excellent plant safety and flexible re-entry times



Item #	Size	Price (\$)
49747	2 oz (12/case)	265.75

ATTAIN (Total Release)

- Same active ingredient as Talstar GH (bifen thrin)
- Excellent “space mix” partner with 1300 Orthene
- Activates thrips to be killed by Orthene
- Safe for poinsettias in color and open blooms
- Whitefly knockdown complete after three days
- REI: 12 hours
- Labeled site: Greenhouses
- Class: Pyrethroid



Controls: Fungus gnats, shoreflies, whiteflies, aphids, and mites.
Rates: 1 canister covers 1,500-3,000 sq ft of crop.

Item #	Size	Price (\$)
45404	2 oz (12/case)	265.75

Sold in case lots only.

PYLON® TR TOTAL RELEASE INSECTICIDE

Pylon TR provides control of mites, thrips, and adult fungus gnats. Pylon TR is ideal for bedding plants, cut flowers, flowering hanging baskets, foliage, fruited vegetables, potted flowering plants, and ornamentals.

- Quick and easy application
- Excellent plant coverage, and flexible re-entry times



Item #	Size	Price (\$)
49748	2 oz (12/case)	277.45

PT1100 PYRETHRUM TR (Total Release)

Natural pyrethrum labeled for use on greenhouse vegetables.

- REI: 12 hours
- Labeled Sites: Greenhouse, Vegetables
- Class: Botanical

Controls: Adult shoreflies, fungus gnats and whiteflies. **Rate:** 1 canister covers 3,000 sq ft of crop.



Item #	Size	Price (\$)
45408	2 oz (12/case)	249.75

Sold in case lots only.

PT1300 ORTHENE TR (Total Release)

- Broad spectrum of activity
- Safe for poinsettias in color and blooms
- Excellent “space mix” partner with Attain TR and Preclude TR
- Active ingredient: acephate
- REI: 24 hours
- Labeled Sites: Greenhouse
- Class: Organophosphate



Controls: Aphids, whiteflies. **Rates:** 6 oz canister treats 3,000 sq ft.

Item #	Size	Price (\$)
45406	6 oz (12/case)	313.75

Sold in case lots only.

SA-20 DISINFECTANT

Horticultural disinfectant used to control pathogens (diseases, infection) by treating mainly greenhouse surfaces and tools.

- Disinfecting greenhouse areas, pots and tools: 1 Tablespoon per gallon of water
- Orchid Culture: 1-2 Tablespoons per gallon of water
- Algae Control: 1 Tablespoon per gallon of water
- Treat Seedlings & Bulbs: 1 Teaspoon per gallon of water
- Other Usages: 1- 1.5 Tablespoons per gallon of water



Item #	Size	Price (\$)
45372	1 gallon	21.00



SULPHUR EVAPORATOR

Sulphur Evaporator can be used to effectively evaporate sulphur. The application of the evaporation and convection principles now makes it possible to effectively combat diseases. The active substance is as a gas evenly distributed throughout the greenhouse reaching places which are often hotbeds of danger (near heating and other pipes). Specially suited for cultivation under glass etc. Perfectly safe. Especially recommended to combat mildew in roses. No moving parts, made of top quality aluminum. Oxidation absolutely impossible. Comes equipped with a long life electric heating element. One evaporator is enough for a volume of 2,450 sq ft.



Item #	Description	Price (\$)
41403	Evaporator (1-11)	97.75
	Evaporator (12-24)	90.25
	Evaporator (25+)	83.50
41402	Heating element 120V	51.75
41400	Aluminum cup	12.00

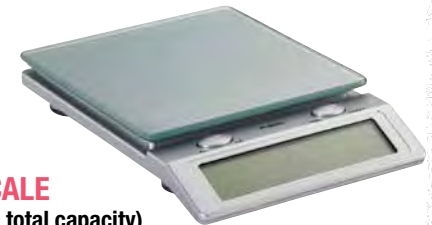

DIGITAL SCALE (6 lb 8 oz/3 KG total capacity)

- Extra large LCD display for easy reading
- Displays in 1/10 oz. or 1 gram increments
- ‘Add & Weigh’ feature: weigh multiple items without removing from scale
- Auto shut-off feature
- Batteries included

Item #	Price (\$)
41083	40.00

Note: If you do not see the chemical you are looking for, please contact us. We have many chemicals available that are not listed in our catalog.

INJECTOR 11 GPM – D25F1VFI

Perfect portable injector.

- 11 GPM flow rate
- Fixed at 1:100 (1%)
- Polyacetal blue housing
- Flow range .05 GPM to 11 GPM
- 4.3 to 85 psi
- ¾" NPT inlet/outlet

Item #	Description	Price (\$)
48140	Unit, 14"H x 6 ¼"W	330.00

Includes: Bypass, mounting bracket, suction hose with strainer/weight and quick start guide. Recommended to install 200 mesh filter such as AKF5AP11KIT-A in front of injector.



INJECTOR 14 GPM – D14MZ2VFI

Perfect for one-hose operations and for use with the DosaCart or Li'l Bud-D

- 14 GPM flow rate
- Chemical resistant housing
- Easy-to-read ratio selector
- Flow range .05 GPM to 14 GPM
- 1:500 to 1:50 adjustable
- 4.3 to 85 psi

- ¾" NPT inlet/outlet

Item #	Description	Price (\$)
41195	Unit, 19 ½" H x 6 ¾"W	462.00

Includes: Mounting bracket, suction hose with strainer/weight and quick start guide. Recommended to install 200 mesh filter such as AKF5AP11KIT-A in front of injector.



INJECTOR 20 GPM – D45RE15VI

Built-in bypass and can handle up to two garden hoses

- Flow range .4 GPM to 20 GPM
- 1:500 to 1:66 adjustable
- 7 to 70 psi
- 1" NPT inlet/outlet

Item #	Description	Price (\$)
41196	Unit, 24"H x 7½ "W	640.00

Includes: Mounting bracket, manual bypass, suction hose with strainer/weight and quick start guide. Recommended to install 200 mesh filter such as AKF5AP20KIT-A in front of injector.



INJECTOR 40 GPM – D8RE2VFI

Versatile injector that operates at low flow and low pressure.

- Flow range 2.2 GPM to 40 GPM
- Chemical resistant polypropylene housing
- Easy-to-adjust injection rates
- Easy-to-read graduated scales
- 1:500 to 1:50 adjustable
- 2.2 to 116 psi
- 1 ½" NPT inlet/outlet

Item #	Description	Price (\$)
41194	Unit, 25 ¼"H x 8 ½"W	973.00

Includes: Mounting bracket, manual bypass, suction hose with strainer/weight, and quick start guide. Recommended to install 200 mesh filter such as AKF5AP40-A in front of injector.



INJECTOR 100 GPM – D20SVFI

For large growing operations and can be installed in parallel for flows up to 500 GPM

Manifold for higher flow rates or on a bypass system.

- Flow range 5 GPM to 100 GPM
- 1:500 to 1:50 adjustable
- 2 to 120 psi
- 2" NPT inlet/outlet
- Accurate at variable water flow rates

Item #	Description	Price (\$)
44123	Unit, 55" x 15" w/legs, 42" x 15" w/o legs	2,527.50

Includes: Set of legs, manual bypass, suction hose with strainer/weight, vacuum breaker and quick start guide.



DOSACART – HS15-16

Great for Garden Centers!

- 15-gallon tank
- Translucent Polyethylene tank construction
- 10" no flat tires for maximum mobility
- Drain valve at bottom for easy clean-out
- Accommodates 11, 14, 20, and 40 GPM

Item #	Description	Price (\$)
47205	Unit, 45 ½"H x 16"W x 20" D	411.75

Injector and Quick Hook-Up Kit sold separately.



QUICK HOOK-UP KIT

Includes everything you need for a quick and easy unit installation onto the Dosatron DosaCart.

Item #	Description	Price (\$)
47206	For 11 GPM, 14 GPM	72.25
48142	For 20 GPM	95.75
48143	For Li'l Bud-D	72.25

ACCESSORIES

In-Line Filter with Hook-Up

Protection from Debris in Water Lines

- Flush valve for easy cleaning
- All necessary fittings included



Item #	Description	Price (\$)
48145	11 and 14 GPM filter	30.25
48146	20 GPM filter	43.95
48147	40 GPM filter	114.25
48148	100 GPM filter	214.00

Check Valve For Reducing Water Hammer

- PVC construction
- Stainless steel spring
- 200 psi rating



Item #	Description	Price (\$)
48149	11 and 14 GPM check valve	15.50
48150	20 GPM check valve	22.00
48151	40 GPM check valve	28.25
48152	100 GPM check valve	30.00

For technical assistance on all Dosatron products, please contact your Gloeckner representative.

COMPLETE ASSEMBLED J+ SERIES RATIO:FEEDER® INJECTOR SYSTEMS

Complete Assembled Systems!

Installation and operation has never been easier with Complete Assembled units from H.E. Anderson. Included are all of the necessary H.E. Anderson components, along with pipe and fittings to make the injector ready to go. Simply supply water in, water out, plug in power and place the chemical pickup tubes in the tank.



- Exact and accurate mixing and injecting
- Expandable from one to several solutions
- Positive displacement and volume proportioning
- Digital display panel
- Completely automatic
- Adjustable feed rate without recalibration
- Fine filter not required
- Very accurate feed, does not degrade with age
- Virtually no maintenance needed
- Easy installation and operation

Item #	Mfr #	Description	Price (\$)
51936	JA160S	Base System*	6,902.00
51937	JA160D	Deluxe System**	12,662.00
51938	H4-HD	Fertilizer Pump – Pumper complete 40mL	863.00
51939	A3-VCP	pH Correction – Pumper complete 3mL w/suction pipe	879.00
51940	P1-HCP	Sanitizer Injection – Pumper complete 10mL w/suction pipe	798.00
51941	P-2S	pH Monitoring – pH Monitor w/BNC conv. & probe	1,075.00
51942	E-1S	EC Monitoring – EC Monitor complete	827.00

*Base System includes the J+ Advanced, 160 GPM water meter, 4 position manifold with pilot valve, 16 gallons galvanized steel Blending tank, frame and pipe fittings. Add your choice of pumps, monitors and other accessories as needed.

**Deluxe System includes all of the features of the JA160S base system plus: (2) H4-HD Fertilizer Pumps, (2) A3-VCP Acid Pumps, (1) E-1S Ratio:Guard® EC Monitor, (1) P-2S Ratio:Guard® pH Monitor, (1) p/n: 02584 Compressed Air and Water Kit.

For custom configurations, contact Gloeckner at 914-698-2300 or info@fredgloeckner.com.



J+ ADVANCED RATIO:FEEDER® CONTROLLER



The new and improved J+ Advanced Ratio:Feeder® Controller advances the J Series reputation as the most reliable, accurate, and flexible injection system on the market. With up to eight (8) chemicals that can be injected simultaneously at different rates, the new Controller is ideal for dosing fertilizer, pH adjustment, sanitation, and injection wetting agents, soaps, and other chemicals.



- Features 8 individual 12VDC outputs
- Easy to use 4 x 20 LCD and 12 button interface
- 4-line alphanumeric display and 12 button keypad
- Re-settable and permanent flow totalizers
- Adjustable feed rate without recalibration
- Controls various solenoid pumps
- Works with existing H.E. Anderson components
- Units can be powered using 120VAC or 12VDC
- Easy installation and operation
- 15 month warranty

For custom configurations, contact Gloeckner at 914-698-2300 or info@fredgloeckner.com.

RATIO:GUARD® pH & EC MONITORS

Accurate. Reliable. Convenient. Keeping tabs on your chemical levels has never been easier. By applying the same principles of simplicity and efficiency used on their injectors, Anderson has created monitors with in-line probes that show a continual reading. They'll stand guard with minimal action on your part. Just give them an occasional cleaning and calibration.

- Continual pH or EC indication
- Large LCD display
- 2 Settable alarm points
- Maintains accuracy with long cable lengths (25')
- Easy to install and maintain

Item #	Mfr #	Description	Price (\$)
44384	E-1S	EC Monitor w/Sensors	827.00
44386	P-2S	pH Monitor w/Electrode, with new separate signal conditioner	1,075.00
49130	11578	P-1 to P-2 Upgrade Kit	353.00
49131	06916	pH Calibration Kit	21.10
47416	06924	pH Calibration Refills (10 each/7&4)	24.30

Anderson pH & EC Monitors include the control box and all necessary probes and quick-tees. pH monitors come with calibration supplies.

DD & DB SERIES RATIO:FEEDER®

DD & DB injectors are perfect for the grower who needs a quality injector that can handle all their water treatment needs.



- Positive displacement and volume proportioning
- No sliding seals
- Adjustable feed rate without recalibration
- Fine filter not required
- ¼ to 20 GPM or ¾ to 50 GPM water flow capacity
- Very accurate feed, does not degrade with age
- Virtually no maintenance needed
- Easy installation and operation
- May be powered by 120 VAC, 12 VDC battery or solar power system
- Optional water flow totalizer available

Item #	Mfr #	Description	Price (\$)
44339	DB100	20 GPM – 1:100 to 1:1000 Ratio	1,272.00
47417	DB100W	DB100 Wall Mounted Unit	1,590.00
49095	DB1000	20 GPM – 1:1000 to 1:10000 Ratio	1,272.00
47418	DB1000W	DB1000 Wall Mounted Unit	1,590.00
49096	DB1200	20 GPM – 1:1200 to 1:12000 Ratio	1,272.00
49128	DB1200LP	Same as DB1200, Low Pressure	1,484.00
47419	DB1200W	DB1200 Wall Mounted Unit	1,590.00
44341	DD100	50 GPM – 1:100 to 1:1000 Ratio	2,120.00
49097	DD1000	50 GPM – 1:1000 to 1:10000 Ratio	2,120.00
49098	DD1200	50 GPM – 1:1200 to 1:12000 Ratio	2,120.00
49129	DD1200LP	Same as DD1200, Low Pressure	2,332.00

Anderson DD & DB Wall-Mount Series chemical injectors come complete with mounting plate, blend tank, and are pre-plumbed for easy installation.



Accessories

Item #	Mfr #	Description	Price (\$)
51943	11586	pH Probe w/BNV (P-2S)	239.00
51944	19632	Quick Tee 2 for EC/pH Probes	55.40
51945	19654	Retainer, U-Pine	6.35
51946	14978	EC/Temp Cable w/Boot, 15'	40.20
51947	11501	Temp sensor, Less Tee	136.00
51948	11519	EC Sensor, Less Tee	171.00



HANDHELD PH AND EC TESTERS & METERS

Portable, high-performing equipment when fast and accurate measurements are required.

ECO pH Tester

Low battery warning • Fast readings • Water resistant • Rewettable tips • Great value

Item #	Description	Price (\$)
49445	PH-80 ECO pH Tester	51.95

PRO pH Meter

Measures 0.00-14.0 pH • Low battery warning • Floating waterproof body • Easy automatic digital calibration • Replaceable probe • Includes lanyard

Item #	Description	Price (\$)
49446	PH-200 PRO pH Meter	86.25

Accessories		
49448	PH-P7 Calibration Solution, ready to use, 20/box	26.00
49449	PH-STOR Storage Solution, pH electrode 60 cc	7.75
49450	SP-P1 replacement pH sensor for pH-200	55.50



Digital ECO EC Tester

Fast and accurate readings • Dry storage, no liquid needed • Low battery warning • Water resistant • 1-year warranty • Great value

Item #	Description	Price (\$)
49443	COM-80 ECO EC Tester	41.50

Digital PRO EC Tester

Measures EC/PPM /TEMP • Pinpoint accuracy, versatile – 0.5 & 0.7 scale • Easy digital calibration • Low battery warning • Replaceable probe • Floating waterproof body • 1-year warranty • Includes lanyard

Item #	Description	Price (\$)
49444	COM-100 ECO EC Tester	64.50

Accessories		
49451	SP-C1 replacement TDS/EC Sensor for COM-100	42.50
49447	CP-1000 Calibration Solution, ready to use, 20/box	26.00



HOZON BRASS SIPHON MIXER

Easily and accurately applies soluble fertilizer to lawn, garden and greenhouse plants.

- Attaches to standard hose fittings
- Features back-flow preventer should pressure fail
- Spring filter eliminates clogging
- Durable brass body construction



Item #	Description	Price (\$) 1-11	Price (\$) 12+
41198	Kit	23.75	21.50



AGRI-METERS

Regular testing of soils, fertilizer solutions and water are a critical component of proper plant management.

Soil – Optimum soil pH is essential for obtaining maximum efficiency from fertilizers and herbicides. This is especially true for artificial growing media which are much more pH sensitive than natural soil. In addition, the pH of artificial soils can vary greatly when new, and must be adjusted before use. Dissolved salts in soil must also be monitored to guarantee healthy plants. If excessive salts accumulate in the soil, roots will take in little or no soil solution, resulting in reduced plant growth and quality. Rest easy however, with regular use of a Mylon L AG6/PH Agri-Meter.

Fertilizer Solutions – Regular testing of conductivity insures that fertilizer solutions will contain the optimum level of salinity for maximum plant health and growth. By taking sample solutions in a timely manner, proper adjustment of the fertilizer injector can prevent over or under feeding, plant damage and fertilizer waste.

Water – Water pH can vary greatly from month to month because of rainfall effect on the aquifer. Agri-Meter tests water pH and salinity fast and easy, with readings provided in millimhos/conductivity. Additionally, the correct pH of water used in pesticide solutions is also important in order to ensure maximum effectiveness and prevent pesticide “break down.”

AG6/PH Agri-Meter

Checks soil pH and salinity • Checks water pH and salinity • Checks correct fertilizer concentration • Checks boiler water conductivity • Automatic temperature compensation means no thermometers or adjustments • Only small amount of soil needed for testing

Item #	Description	Price (\$)
41517	AG6/PH, 0-5000 Millimhos	575.50
41525	1 quart, pH4 reference buffer solution	29.50
41526	1 quart, pH7 reference buffer solution	29.50
41524	1 quart, pH10 reference buffer solution	29.50
41527	1 quart, TDS/conductivity solution	29.50

AG-5 Agri-Meter

Tests conductivity/salinity only • Portability, 3" x 4" x 4" weighing less than 1 pound • Easy to use, just pour a sample into the built-in cell and press the button • Economical option

Item #	Description	Price (\$)
41516	AG-5, includes 9-volt battery	258.50
41527	1 quart, TDS/conductivity solution	29.50





MIST'R DRENCH SPRAYERS

Durable Siebring Sprayers are a must-have for greenhouses, nurseries, vegetable farms, orchards and flower gardens.

- Quick connect for draining or washing polyethylene tank (lid included)
- Balloon tires for easy roll on gravel or concrete
- Ball bearing mounted hose reel for 250' payout and rewind
- Drenching crook & 18" extension
- 800 PSI of pressure
- 3.0 GPM flow
- 100' wire braid hose with hose reel (standard)
- Constant agitation for wettable powders in the tank
- Towing tongue

Item #	Model #	Motor	Tires	Tank	Price (\$)
45210	MD83BW	1.5 HP 120V	16"Ø x 4"W	60 gal	6,013.00
45211	MD83BWG	4 HP Gas	16"Ø x 4"W	60 gal	6,093.00
45207	MD100	1.5 HP 120V	16"Ø x 6.5"W	100 gal	6,949.00
45208	MD100G	4 HP Gas	16"Ø x 6.5"W	100 gal	6,991.00

Order includes:

- 3-piece nozzle for high or low misting
- (1) drenching water breaker screen nozzle
- (2) guns, (2) 18" and (1) 12" wand with drench hook
- (1) 12" curved (hook) extension for hanging baskets
- Back flush connector for easy cleaning
- 0° to 15° pressure nozzles



FOX DRENCH SPRAYERS

The FOX is a highly maneuverable, 4-wheel sprayer suitable for narrow aisles and tight turns. Easy change tongues make hand maneuvering a snap, and small vehicle transporting possible. 10" diameter, flat-free, easy ride tires smooth the bumps on uneven ground, but never need air.

- Fits 22" aisle
- Fresh water back flush for easy clean out
- Highly maneuverable
- 4 wheels with narrow front steering allows for 90° aisle turn
- "High Action" recirculating tank agitation
- Chemical saver tank shutoff valve
- Tapered bottom tank for drainability, ½" additional drain is provided
- 800 PSI @ 3 GPM
- 3 GPM Flow
- 100 ft. of hose (standard)
- 200 ft. reel capacity of ¾" hose
- CAT pump with 3 ceramic plungers
- Quick adjust pressure control
- Fluid filled gauge
- 2 guns for misting & drenching
- Quick couple fittings for fast & easy maintenance
- Bypass pump protection
- 22" cart clearance for narrow spaces

Item #	Model #	Motor	Tires	Tank	Price (\$)
45203	FOX	1.5 HP 120V	10"Ø x 3.5"W	35 gal	4,436.00
45204	FOX GAS	4 HP Gas	10"Ø x 3.5"W	35 gal	4,516.00



KRUSER POWER SPRAYERS

- Bottom tank Drain
- Sump in the tank that re-circulates for maximum usage
- Includes a mist nozzle assembly
- 18" wand
- High pressure gun
- Constant agitation suspends wettable powders
- 750 PSI of pressure
- 1.5 GPM flow
- CAT pump
- Direct drive
- 100' x ¼" hose with reel
- 25' electrical cord
- 10" "No Flat" tires
- 25 gallon poly tank

Item #	Model #	Motor	Tank	Price (\$)
45205	KS-750-100	1.5 HP 120V	25 gal	2,923.00
45206	KS-750-G100	4 HP Gas	25 gal	3,166.00

Many New Products for 2018-2019!

Page 51



Need a Helpful Hand?

See pages 2 & 3 for the listing of the Gloeckner Field Representatives – including yours!

PulsFOG® Turbo ULV



Pneumatic Cold-Fogger

The Turbo ULV is perfect for spot spraying of hot spots of bugs, diseases or a small grower that doesn't want to drag a hydraulic sprayer around. Because this is a cold fog, the Turbo ULV is ideal for the application of bio-rational products.

- Electrically powered turbine creates a strong, warm flow of air that atomizes and propels fog up to 75 feet, depending on the particle size
- Hand-held nozzle directs flow were you want; multiple nozzles offers different flows and particle sizes
- Corrosion-free components can withstand corrosive product



Item #	Description	Price (\$)
51709	Unit	Call for Price

Specifications			
Power	110v AC 4.4A	Flow Rate	0.7 mm nozzle - 5.3 L/hr
Tank Size	5 liter		0.8 mm nozzle - 5.3 L/hr
Particle Size	10-100 µ		1.0 mm nozzle - 5.3 L/hr

MLVH Mini AutoFog™ Chemical Applicator

Ideal for Small Greenhouses!

The MLVH can treat 5,000 sq. ft. automatically without an operator present. What's more, it can easily apply a wide variety of chemical formulations using a highly concentrated spray solution. Specially designed nozzle generates billions of micro-particles (5-10 microns) that fill the entire treatment area with active chemicals. These tiny particles ensure complete and even coverage of all plant surfaces.

- "Low-volume" method of application eliminates costly run-off and reduces the amount of chemicals needed
- Mechanical agitation keeps chemicals in suspension
- Patented precision nozzle creates evenly sized droplets for best distribution spray
- 8 liter tank; 2-wheel dolly design; 110V works everywhere



Item #	Description	Price (\$)
45777	Unit, MLVH-10A	3,195.00
51710	Unit, MLVH-10A with Stainless Steel Nozzle	3,848.00

See page 65 for specifications.

DRAMM CHEMICAL APPLICATIONS

PulsFOG Fast Foggers

New Engine Sizes!

The Dramm PulsFOG Fast Foggers treat both small and large greenhouses quickly and efficiently reducing labor costs, exposure, and poor coverage.

- Up to 10 times faster than wet-spraying
- Creates a 12 micron droplet that hangs for hours and covers all surfaces
- Fog bios and oxidizers for softer crops
- Lightweight and portable for ease-of-use

K-10 Model

25 HP • 1 nozzle • Treats 45,000 sq. ft. in 60-65 minutes

Item #	Mfr #	Description	Price (\$)
45793	K-10	Unit	2,895.00

K-22 Model*

50 HP • 1 nozzle • Treats 45,000 sq. ft in 30-35 minutes • Throws fog 120'

Item #	Mfr #	Description	Price (\$)
45794	K-22	Unit	3,995.00

K-30 Model*

100 HP • 2 nozzles • Treats 45,000 sq. ft. in 15-20 minutes

Item #	Mfr #	Description	Price (\$)
45796	K-30	Unit	5,095.00

*Optional Bio units and larger sizes available upon request.

	K-10	K-22	K-30	K-30/20 Bio
Weight Empty	18 lbs	18 lbs	25 lbs	67 lbs
Output Time	10 L/45 min	10 L/30 min	10L/15 min	30L/45 min
Chem Tank Capacity	10 liters/2.6 gallons	10 liters/2.6 gallons	10 liters/2.6 gallons	(2) 30 liters/7.9 gallons
Fuel Tank Capacity	2 liters/0.5 gallons	2 liters/0.5 gallons	2 liters/0.5 gallons	(2) 20 liters/5.3 gallons

NutriFOG Carrier for PulsFOG



NutriFOG is the recommended carrier for use with Dramm PulsFOGs in greenhouse and nursery production.



Item #	Mfr #	Description	Price (\$)
48164	NF-20	20 liter pail, each	280.00

	K-10	K-22	K-30	K-30/20 Bio
Throw	50-60 ft	100-120 ft	150-160 ft	150-160 ft



NEW! K-30/20 Bio

100 HP • 2-55 liter tanks • Treats 210,000 sq. ft. in 80-90 minutes

Item #	Mfr #	Description	Price (\$)
51911	K-30/20 Bio	Unit	6,595.00

Solutions

- VK-I: To be used with oil-based insecticides and fungicides
- VK-II: To be used with wettable powders, soluble powders, water soluble, water suspendible and water flowable pesticides

Item #	Description	Price (\$)
45824	#VKI (5 gallon)	195.00
45825	#VKII (5 gallon)	245.00

DRAMM CHEMICAL APPLICATIONS



SLVH Autofog™

- Automatic chemical application
- Low volume spraying
- Treats 12,000 sq ft
- Treats 26,000 sq ft with additional fans
- 120 volts 60 HZ
- Separates for portable use

Item #	Description	Price (\$)
45778	Unit, SLVH-20A	6,295.00

LVH Autofog™

- Automatic chemical application
- Low volume spraying
- Treats 30,000 sq ft
- Treats 70,000 sq ft with additional fans
- 240 volts 60 HZ
- Separates for portable use

Item #	Description	Price (\$)
45774	Unit, LVH-20A	7,395.00



	MLVH AutoFog™	SLVH AutoFog™	LVH AutoFog™
Chemical Tank Volume	8 liters	7 liters	14 liters
Chemical Output Rate	45cc/min	45cc/min	55 cc/min
System Rated Load	10.3 amp	11.1 amp	8 amp
Compressor HP	¾ hp	¾ hp	1 hp
Compressor Output	2.43 CFM @ 21 PSI	2.43 CFM @ 21 PSI	4.06 CFM @ 28.5 PSI
Cord Length	4 ft	-	-
Hose & Cord Length	-	33 ft	100 ft
Dimensions	10" wide	18.25" wide	18.25" wide

CD2 Chemdose™

- Precisely measures chemical doses
- Use as single shot or interval based doses
- Works with an injector or sprayer; any source less than 100 psi
- Variable interval between dosing
- Advanced features such as dose count, maximum number of doses & control lock-out
- +/- 1ml per cycle accuracy
- 12v DC, rechargeable power supply



Item #	Description	Price (\$)
48168	Unit	3,100.00

COLDFOGGER™

The ColdFogger is a *low-volume* chemical applicator that can easily apply all formulations of pesticides, growth retardants, fungicides, vaccines, cleaning products, and disinfectants using a highly concentrated spray solution. This *low-volume* method of applying chemical solution diminishes costly run-off and greatly reduces application times.

- Small droplets are generated to provide deep and even penetration of chemicals
- 20 gallon tank (treats 70,000 sq. ft.)
- High pressure fog projects a plume of 30-60 micron diameter spray droplets 20'-25'
- 3000 psi pump for ultra-fine spray and exceptional coverage
- Built in hose reel conveniently stores 150' of high pressure discharge hose; reversible reel guide flips to either side for easy winding and unwinding
- Motor – 110 v 60 Hz 10 amp
- Standard solid rubber tires and casters
- Operation is easy and maintenance is minimal; sumped drain empties tank completely



Item #	Description	Price (\$)
51711	Unit, CFAR-20/150	3,425.00
51712	Unit, CFAR-20/150-BF, with BigFoot Pneumatic 15" tires and casters	4,625.00

Also available with a 50 gallon tank and 300' hose.

AGITATION/AERATION BUCKET

Dramm's Agitation/Aeration Bucket provides a thorough mixing of any solution. Perfect for use with an injector, the A/A Bucket can keep water soluble fertilizers, fungicides, insecticides, and PGR's in suspension.

- Easy to carry enclosed pump
- Eductor for increased flow
- Agitate or aerate switch
- 5-gallon capacity, 0.7 GPM flow rate
- Adds dissolved oxygen for Nematode application
- AC or DC options



Item #	Mfr #	Description	Price (\$)
51714	AAB120V	Unit, Multi-Voltage (100-240V) US Plug	495.00
51912	AAB12V	Unit, 12V DC Battery Powered	659.00

FC50-A-DT FERTICART™

Dramm's 50 gallon Ferticart is a durable fertilizer stock solution cart and tank with on-board agitation. The AC powered pump provides up to 5 gallons per minute of agitation and uses a unique agitation bar to keep stubborn chemicals in the solution.

- Includes air injection to aerate tank
- System maintains saturation levels of dissolved oxygen and can keep nematodes viable during application
- Works with the Dosatron D8 GPM or D45 20 GPM Injectors
- Drain valve for easy cleaning
- 200 mesh filter
- Corrosion resistant vinyl coated frame

Item #	Mfr #	Description	Price (\$)
51713	FC50-A-DR8	Unit	2,495.00

Fertilizer Injector not included.

FC-20 Ferticart™

The portable FC20 fits down most greenhouse aisles while the low center of gravity, low hose draw point and well-balanced cart prevents tipping. The FC20 comes as a complete kit including a filter to protect the injector and a check valve to prevent back flow of chemicals in the tank.

- Pre-assembled plumbing, just add the injector
- PVC unions make assembly and disassembly fast and easy
- Long-lasting, vinyl coated cart
- Solid rubber no-flat wheels; locking rubberized casters

Item #	Description	Price (\$)
48170	FC20-DT Dosatron™	599.00
48171	FC20-DM Dosmatic™	599.00
Tank Volume	20 gallons	

*Injector sold separately.

DRAMM HYDRAULIC SPRAYERS

Hydra™

- High volume hydraulic sprayer
- 50 gallon tank on mobile cart
- Applies most chemical formulations
- Variety of droplet sizes & spray distances
- 115 volts or 220 volts 60 HZ
- 250' 3/8" hose option

Item #	Description	Price (\$)
48159	Electric, HYDRA50/150	3,495.00

Hydra™ SprayTrax™ 100

- Hydraulic sprayer
- 100 gallon tank on self-tracking cart
- Applies most chemical formulations
- Single or dual hose reel option

Item #	Description	Price (\$)
48160	Gas, HYDRAG-ST100/250	5,595.00



Hydra SprayTrax 50 – Electric/Gas

- High volume hydraulic sprayer
- 50 gallon tank on self tracking cart
- Applies most chemical formulations
- Variety of droplet sizes & spray distances
- 115 volts or 220 volts 60 HZ – electric
- 5.5 hp Honda gas engine

Item #	Description	Price (\$)
48161	Electric, HYDRA50/250	3,995.00
48162	Gas, HYDRAG-ST50/250	4,500.00



HydraSkid™

- High Volume Hydraulic Sprayer
- Applies most chemical formulations
- Variety of droplet sizes & spray distances

Item #	Description	Price (\$)
48163	Gas, HYDRA-SKID50/250	4,495.00

	HYDRA50/150	HYDRA50/250	HYDRAG-ST50/250	HYDRAG-ST100/250	HYDRA-SKID50/250
Chemical Tank Volume	50 gallons	50 gallons	50 gallons	100 gallons	50 gallons
Chemical Output Rate	up to 3.8 gpm	N/A	N/A	up to 7 gpm	up to 7gpm
Maximum Pressure	up to 500 psi	up to 500 psi	up to 500 psi	up to 500 psi	up to 500 psi
Pump HP	1.5 hp electric	1.5 hp elec. – 3.8 GPM	5.5 Honda gas – 7.6 GPM	5.5 hp Honda gas	5.5 hp Honda Gas
System Rated Load	18 amp or 8 amp	N/A	N/A	N/A	N/A
Hose Length	150' w/var. drag reel	250' w/var. drag reel	250' w/ var. drag reel	250' w/var. drag reels	250' w/var. drag reels
Dimensions	27" wide	34" wide	34" wide	38" wide	22" wide



MSO Sprayer

- Multi-purpose hydraulic sprayer
- Applies most chemical formulations
- Corrosion-resistant pump
- 120 volts 60 HZ

Item #	Description	Price (\$)
45804	MSO-Electric	768.00

MS20 Sprayer

- Multi-purpose hydraulic sprayer
- Multi-position reel placement
- Applies most chemical formulations
- Corrosion-resistant pump
- 120 volts 60HZ

Item #	Description	Price (\$)
45801	MS20-33 Electric	1,199.00
45802	MS20-100 Electric	1,599.00

	MSO	MS20-33	MS20-100
Chemical Tank Volume	not incl.	20 gallon	20 gallon
Chemical Output Rate	up to 0.5 gpm	up to 0.5 gpm	up to 0.5 gpm
Maximum Pressure	up to 500 psi	up to 500 psi	up to 500 psi
Compressor HP	¼ hp electric	¼ hp electric	¼ hp electric
Drive System	direct drive	direct drive	direct drive
Cord Length	8 ft.	N/A	N/A
Hose Length	N/A	33 ft.	100 ft.
Spray Distance	stream-20', mist-10'	N/A	N/A
Discharge Hose Length	N/A	N/A	N/A
Dimensions	N/A	20.5"W x 36.5"L	20.5"W x 36.5"L



DRAMM BP-4 BACKPACK SPRAYERS

- Even, constant spray
- Apply all formulations of chemicals
- Great for growth regulators
- No hand pumping – tank not pressurized
- Fine mist to straight stream output
- Padded shoulder straps & back rest



Item #	Mfr #	Description	Price (\$)
48166	BP-4	Basic Unit	489.00
48167	BP-4QCB	Unit w/swapable battery	575.00

*L-5 Lance available upon request

BP-4/BP-4QCB	
Tank Volume	4 gallons
Chemical Output Rate	Max. 1 gal/min
Power Supply	12v DC; rechargeable
Length of Charge	2 hrs
Weight when Full	40 lbs
Charge Time	7 hrs

DRAMM WC-20 WATER CART

- Portable watering system
- 4 gpm output
- Rechargeable
- Pumps up to 300 gal before charging
- Constant flow
- 20 gallon tank volume
- 12v rechargeable power supply
- 12 feet hose length



Item #	Description	Price (\$)
48169	Unit	1,160.00



BACK PACK 4 GALLON SPRAYER #614PR

- Ergonomically designed tank comfortably fits on your back
- Heavy-duty poly flow control with poly wand and adjustable poly nozzle; flat fan, stream and cone nozzles included
- Left or right hand pumping
- UV inhibitors for light sensitive chemicals



Item #	Description	Price (\$)
47049	Unit	133.50



40TS PUMP SPRAYER

- 2.5 pint translucent polyethylene tank
- 360(degree) any angle spraying – even upside down
- Trigger has lock-on feature
- Adjustable spray nozzle



Item #	Description	Price (\$)
48172	40 oz	12.95

DRAMM

For Dramm, sustainability has been central to its business model since the company's inception.



2 GALLON ECONOMY SPRAYER

- Easy fill funnel top polyethylene translucent tank
- All poly flow control with lock on feature
- 38' hose, 14" corrosion resistant poly wand with poly flat nozzle for wide coverage
- Storage clip for wand built into pump handle



Item #	Description	Price (\$)
41533	2 gallon	26.00



ULTRA LOW VOLUME SPRAYERS #1035B

Designed to emit an ultra-fine chemical mist, the ULV's precise output is very effective in controlling usage of expensive chemicals. Perfect for pest control and smoke odor control.



- Discharges particles of 8.5 microns up to 100 feet in still air
- Flow control needle valve has precise discharge volume control ranging from .25 oz-13.3 oz per minute
- Atomizing nozzle reduces particle sleeve without degrading heat-sensitive chemicals
- Commercial grade, 110 Volt motor AC, 60 Hertz, 7.0 Amp 2 stage fan

Item #	Description	Price (\$)
45172	Unit	386.75



ATOMITE AIRBLAST ELECTRIC MIST SPRAYER #1026B

The "Atomite" is ideal for misting and fogging large areas.

- Equipped with 110 volt motor
- Output adjusts from 1.5-14 gph
- Does not damage chemical composition as thermal foggers do



Item #	Description	Price (\$)
45171	Unit	226.00

Antal / Cayson Equipment

Antal/Cayson was the first company to introduce a manually operated extractor.

- Equipment has been designed for ease-of-use
- Efficient design dislodges plugs in seconds
- Equipment features a modular design with components being interchangeable
- Equipment is built with quality materials for long-lasting use

Standard Popper

Designed for use for any 10" x 20" annual or perennial tray • Easy-to-use manual operation

Item #	Description	Price (\$)
47232	Unit	1,618.00



Standard Popper

Plug Popper Plus

Designed for use for any 10" x 20" annual or perennial tray • Pneumatic operated for maximum efficiency

Item #	Description	Price (\$)
47233	Unit	2,540.00



Plug Popper Plus

Dibble Pro

Portable unit is made of lightweight, yet durable aluminum • Automatic stripper plate keeps the pins clean to make a perfect dibble every time

Item #	Description	Price (\$)
47043	Unit	380.00
48173	Dibble Mate Workstation	430.00

Accessories (Dibble Pins)

49970	Plastic, 1" x 3", ea.	4.11
49971	Plastic, 1" x 2", ea.	3.16
49972	Plastic, 3/4" x 3", ea.	2.79
49973	Plastic, 3/4" x 2", ea.	2.43
49974	Plastic, 5/8" x 2", ea.	2.25
49975	Plastic, 5/8" x 2 1/2", ea.	2.44
49976	Plastic, 1/2" x 2", ea.	2.08
49977	Aluminum, 1/8" x 2", ea.	0.32
49978	Aluminum, 3/16" x 2", ea.	0.47
49979	Aluminum, 1/4" x 2", ea.	0.63



Dibble Pro



Workstation Only

All items are pointer/tapered except 49978 and 49979 which are flat.



Growing Systems, Inc.

CONVERTIBLE PLUG DISLODGER

Designed to accommodate several sizes of plug trays, using a common frame. The entire unit is hot-dip galvanized after welding, and heavy duty construction assures positive alignment. Pins are made of aluminum.

- The top hold-down cover is designed with a locking device
- Floor Model, equipped with two 4-inch caster wheels, can be easily moved to various locations
- Exchangeable inserts and hold-down units, installed with thumb screws, allow several plug tray sizes to be dislodged with one machine
- Available with Manual Foot Treadle or Automatic Air Assist
- Depth of Pin Penetration is adjustable
- Available in Lid Style, or Bar Style for taller plant material

Item #	Description	Price (\$)
48188	Dislodger main frame w/locking device	830.00
48189	Tray insert/hold-down device	350.00
48190	Steel pins, each	2.07
48191	Dislodger main frame, tray insert/hold-down device w/200 steel pins	1,594.00
48192	Dislodger main frame, tray insert/hold-down device w/273 steel pins	1,745.11
48193	Dislodger main frame, tray insert/hold-down device w/288 steel pins	1,776.16
48194	Dislodger main frame, tray insert/hold-down device w/392 steel pins	1,991.44
48195	Dislodger main frame, tray insert/hold-down device w/400 steel pins	2,008.00
48196	Dislodger main frame, tray insert/hold-down device w/406 steel pins	2,020.42
48197	Dislodger main frame, tray insert/hold-down device w/512 steel pins	2,239.84



Growing Systems, Inc.

VANDANA TUBELESS SEEDERS

- Developed to handle a larger range of seeds from fine seed like Petunia to coarse seed like Melon and Marigold
- Template field expanded to exact size of tray to allow space for long seed to singulate
- Will handle any tray sizes
- Sows entire tray at one drop
- Templates cleaned automatically between drops
- Features variable speed vibrator with momentary switch
- Has a variable adjustment to accommodate trays or pots from 1" to 4" high
- Includes portable table cart with durable galvanized sheet metal shelves and accessory shelf

Templates: (Custom-made to order only and are priced separately.)

- #1 Geranium, Cabbage, Cauliflower, Lettuce, Round, Semi-Round and Pelleted Seed.
- #3 Petunia, Snapdragon, Fine Round Seed, Single Drop, Clump Seeding of Lobelia and Portulaca.
- #4 General Purpose, Pansy, Coleus, Certain Impatiens Varieties and Semi-Small Seed. Clump Seeding of Alyssum.
- #9 Pepper, Tomato, Marigold, Raw or De-tailed, Marigold – Coated (Silver Bullet or Speed Seed).

Item #	Description	Price (\$)
44261*	Unit includes Seeder, complete with Table Cart, Automatic Air Seed Release and Air Tray-Stop	5,100.00
48198	Portable Air Compressor w/Hose Fittings (required)	218.75

*Air compression (60-80 PSI) is required and is not included with unit purchase.

Please specify the following information: Tray Manufacturer – tray description; Number of cells per tray; Number of seeds per cell; Kinds of seeds. When reordering additional templates, also state the model and serial numbers (as shown on the metal tag on your seeder).



Seederman GS1 SEMI-AUTOMATIC NEEDLE SEEDER

The Seederman Needle Seeder offers flexibility and speed in one self-contained durable unit.

- Sows up to 120 trays per hour
- 100% air operated, no electricity required
- Long-lasting aluminum and stainless steel construction
- Will accommodate trays from 32 to 512 cells
- Change flat size in less than 5 minutes
- Seed collector; blow gun for cleaning
- 2-year warranty on all parts except needles



Item #	Description	Price (\$)
49788	6' bed length	5,450.00
49789	8' bed length	5,750.00
Accessories		
49791	Sowing Kit, (no dibbler)	200.00
49792	Leg Kit, free standing	550.00

Ask about the larger, higher performing GS2, GS3, and GS3-HD models.

PRO-GROW SPACE SAVER PROPAGATING CHAMBER

Special design returns condensed moisture to return pan, reducing refills. Additionally, eliminates need for external water tank.

- Heavy-duty welded steel frame; factory paint with stainless steel brackets; heavy-duty stainless casters
- Stainless steel shelves; storage rack for removable door panels
- Special low heat, low density electric heaters
- Durable thermostats for temperature control, range 40-100°F



Item #	Mfr #	Capacity (1020 Flats)	Electrical	Size	Price (\$)
44955	PC-22	22	120VAC-500W-4.2A	25" x 31" x 70"	1,984.00
44956	PC-46	46	120VAC-875W-7.3A	25" x 51" x 70"	3,306.00
44957	PC-70	70	120VAC-1750W-14.6A	25" x 86" x 70"	4,966.00

*Adopt the pace of nature; her secret is patience.
~R.W. Emerson*

BERRY PRECISION SEEDER *New Listing!*

Ideal for small to midsize operations, the Berry Seeder featuring the patented seed channel is one of the most accurate seeders on the market today. What's more, the flexible usage of the Berry Seeder extends to watermelon, raw petunias, cell packs, and more.



- Seed up to 250 trays per hour with unequaled accuracy
- Seeds the whole plug tray at once, not one row at a time
- Made of lightweight polycarbonate and machined aluminum
- Transparent seeder body allows for easy inspection of clogged holes and/or misses
- No motors, solenoids, bearings, or electrical components to break down

Please contact us for pricing/seed chart information.

EARTHWAY PRECISION GARDEN SEEDER



- Eliminates the problem of seed rot and skipped plants
- Plants row crops fast and easy
- Plants at precise depth, space and covers and packs all in one pass
- Features a durable, yet lightweight aluminum frame

Item #	Description	Price (\$)
44138	Unit - Includes six seed plates*, adjustable depth gauge and 30" row marker	132.95
48174	Seed Plate Storage Case	23.75
44137	Fert-A-Ply 5#/2.2kg Adjustable Side-Dress Fertilizer Attachment	70.75
44139	Seed Plate Kit for Kale, Cabbage, Cucumbers, Popcorn, Lima Beans and more	25.25

*Seed plates included: Corn, Radish/Leeks/Spinach, Carrots/Lettuce/Turnips, Beans/Small Peas, Jumbo Peas, Beets/Okra/Swiss Chard.

GROMOR® VIBRO HAND SEEDER

Fast, accurate, individual dispensing of even the smallest seeds. With the Vibro Hand Seeder, seeds are evenly distributed over the length of the spatula; the seeder is held level over the flat or plug tray to be filled; and vibration speed control is adjusted until seed moves slowly off tip of spatula.

- Dispensing speed can be controlled by tilting seeder up or down
- Can be used at slower speeds for individual seed dispensing in plug trays or speed it up for a controlled spill into 20-row seed flats
- Powered by one 9v battery (included)



Item #	Description	Price (\$)
41559	Unit	73.75
41552	Tip Magnifier accessory	14.00
41444	Power Supply Adaptor	28.25



– AN IDEAL PARTNERSHIP THAT WORKS FOR YOU!

Two renowned and well respected firms in the horticulture industry have partnered to bring you the best in LED lighting solutions. Philips has extensive expertise and experience in both conventional lighting and state-of-the-art LED lighting technology for horticulture purposes. Combined with Gloeckner's market expertise, we'll be able to offer optimum light recipes to save energy and make plant production more profitable.



Philips LED Lighting – Growth Like Never Before

LED lighting is here now, and promises to be the dominant lighting method sooner than later. And here's why:

- Supplements natural daylight and enhances photosynthesis which drives growth and improves quality of plants in greenhouses
- Controls the light period by extending the natural day length with artificial light
- Replaces daylight with artificial light for maximum climate control
- Energy efficient; long-life; low heat radiation; light and heat can be separately controlled; and more

Call for Expert Consultation and Product Pricing

The best fit light recipe depends on a great many factors, and that's why it's important that you allow us to learn more about your specific needs and to recommend the best lighting solutions. Call us now at 800-345-3787 for dedicated assistance.

GREENPOWER LED TOPLIGHTING

LED Toplighting produces significantly less heat, especially less radiation heat, than conventional HPS lamps, so you can control your greenhouse climate more precisely and grow better crops faster, year-round. Less heat gives you more flexibility to use light more effectively; for example, by increasing light levels, extending lighting periods, or by using light on warmer days without having to ventilate. Less heat also means you can place the light source closer to your plants to reduce light loss even in low-ceiling greenhouses.

- **Improves Production:** Shortens growth cycles; Improves color, shape, and taste; Grow with more control over your climate; Grow year-round in low greenhouses
- **Cut Operational Costs:** Saves up to 42% on energy costs compared to HPS toplighting; Reduces cost of power infrastructure to obtain your light level; Avoid costly remodeling with easy plug and play installation; Lower maintenance costs
- **Long-Life:** Emit at least 90% of their output after 25,000 hours and can last 5 times longer than conventional HPS light sources



Item #	Mfr #	Description	Case Pk	Price (\$)
GreenPower LED Toplighting				
49342	303818	Deep Red/Blue/Low Blue	3	
49344	303842	Deep Red/Blue/Medium Blue	3	
49345	303859	Deep Red/Blue/High Blue	3	
49346	303867	Deep Red/White/Low Blue	3	Call for Price
49347	303883	Deep Red/White/Medium Blue	3	
49348	303891	Deep Red/White VISION/Medium Blue	3	
49349	303909	Deep Red/White/Far Red/Medium Blue	3	
Toplighting Accessories				
49350	303966	End Cap	100	
49351	303925	Mounting Bracket	200	
49999	324061	Jumper Cable (3.3 ft L/1.00m)	15	Call for Price
49352	303933	Jumper Cable (6.6 ft L/2.01m)	15	
49353	304188	Mains Power Cable (pre-assembled w/female connector)	15	

	Application	Crops	Spectrum
Toplighting	Increase winter light levels; Extend lighting hours; Night interruption	Supplemental light for: High-light ornamental; High-light leafy greens; High-wire fruit and vegetable	Tailored for your specific crops
Flowering Lamp	Extend lighting hours; Night interruption	Photoperiodic genera	Blue and red wavelengths vs white-only light
Production Module	Sole-source lighting for: Tissue culture acclimatization; Propagation; Climate cabinets	Leafy greens, ornamental propagation, ornamental production, algae	Tailored for your specific crops
TLED	Sole-source lighting for: Tissue culture	Fruit, vegetable, and ornamental propagation	Blue and red wavelengths vs red-deficient fluorescent light
Interlighting	Below crop canopy lighting for: High-wire crops	High-wire tomato, cucumbers, and peppers; Tall roses	Spectrum specific to stimulate growth

¹ Efficacy of toplighting (efficiency of toplighting can be as much as 50% higher than HPS)
² Efficacy of production module in blue-only spectrum is 1.7 μmol/J; efficacy of all other Philips production modules fall in the range stated above
³ L90 expresses the useful lifespan of an LED indicating the number of hours before light output drops to 90% of initial output at 25 °C / 77 °F. L70 represents number of hours before light output drops to 70% of initial output

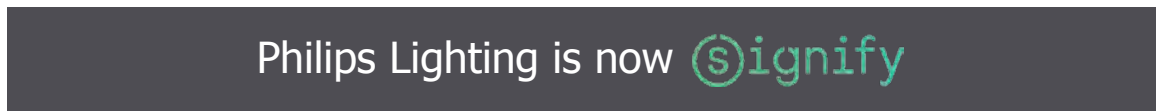

PHILIPS

LED Horti Partner

Learn About My Recipe for Growth

Jim Iwasaki
Iwasaki Bros., Inc., Hillsboro Oregon

"High-pressure sodium for many years was the gold standard for lighting. HPS lights use a lot of power; they are expensive to operate. Growing under the LED lighting is much more efficient. We have shortened our crop cycle by up to three weeks and we get an extra cycle of plants through the greenhouse. That's very exciting, very profitable. Because proper lighting is very important to our growth and success, we are making the switch to Philips LEDs."

Philips
GreenPower
LED Toplighting

GREENPOWER LED INTERLIGHTING MODULE

- The first module that can be positioned between the crops, as a result of the small amount of heat generated by LED lights
- Provides greater control over plant growth, ensuring better results (eg. for tomatoes and roses)

Item #	Mfr #	Description	Case Pk	Price (\$)
GreenPower LED Interlighting Gen 3				
51860	325837	Deep Red/Blue Reg Output (2.5 m)	5	
51861	325845	Deep Red/Blue High Output (2.5 m)	5	<i>Call for Price</i>
51862	325852	Deep Red/Blue Reg Output (2.0 m)	5	
51863	325860	Deep Red/Blue High Output (2.0 m)	5	

Accessories				
51864	327080	Mounting Bracket (171 mm)	250	
51865	327098	Mounting Bracket (271 mm)	250	
51866	325894	Power Cable 5.5.3	6	<i>Call for Price</i>
51867	325902	Jumper Cable 4.5.3	15	
49350	303966	End Cap (Universal)	100	

GREENPOWER LED PRODUCTION MODULE

- Can be used to replace conventional fluorescent lamps (36 or 58W), reduces energy consumption by up to 60%; IP 66 rating makes it ideal for germination rooms and greenhouses (on waterbooms)
- 2 lengths, 120cm (4') and 150cm (5')
- Lifetime 90% output: 25,000 hours

Item #	Mfr #	Description	Case Pk	Price (\$)
GreenPower LED Production Module				
51868	342139	Deep Red/Low Blue 150	6	
51869	342147	Deep Red/Blue/Far Red/Low Blue 150	6	<i>Call for Price</i>
51870	342154	Deep Red/White/Low Blue 150	6	
51871	342162	Deep Red/White/Far Red/Low Blue 150	6	

Accessories				
51872	324277	Power Cable 5.2.2	6	<i>Call for Price</i>
51873	272005	Mounting Bracket	75	

GREENPOWER LED FLOWERING LAMP

- Extends daylight hours
- Up to 90% energy savings
- Presence of far red (crucial for certain crops)
- Easy to install in your current installation or for replacement of incandescents
- Less sensitive to voltage variations
- No start-up time

Item #	Mfr #	Description	Case Pk	Price (\$)
GreenPower LED Flowering Lamp				
50004	285700	Deep Red/White	8	
50001	285718	Deep Red/White/Far Red	8	<i>Call for Price</i>

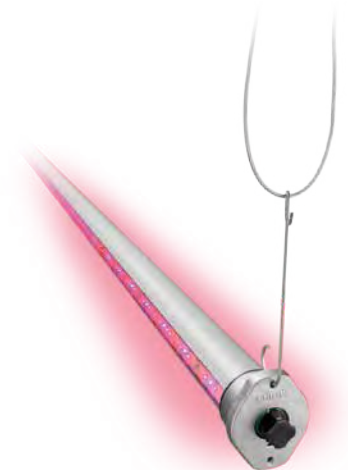

Did you know?

Even when it appears to be bright and sunny, your crops may not be receiving a sufficient amount of light due to the position of the sun, condition and cleanliness of your greenhouse, and structural interference. That's why growers benefit from supplemental lighting during the winter growing months.

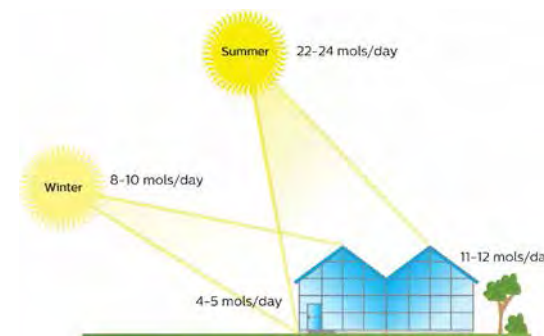

Did you know?

Did you know that not all light is optimal light? In other words, quality growth is the result of quality light. And quality light is in the blue and red wavelengths of the light spectrum.

Did you know?

When thinking about greenhouse lighting, there are three characteristic to factor into your lighting strategy:

1. Intensity: Rate at which light energy is delivered to a unit of surface
2. Duration: Period of time in 24 hours that plants are exposed to light
3. Spectrum: Band of colors produced when sunlight is passed through a prism (violet, indigo, blue, green, yellow, and red)

Philips LEDs provide you with the intensity, duration, and optimal spectrum plus electrical efficiency.

Did you know?

Philips LEDs provide the right greenhouse lighting spectrum to stimulate quality plant growth and have been demonstrated in various genera* resulting in:

- Compact growth
- Sturdier leaves
- Strong rooting
- Prominent pigmentation
- Faster rooting

**Refer to the published case studies on this page for specific crop benefits.*

Did you know?

Benefits of using supplemental Philips LED lighting include:

- Improved crop production planning and scheduling
- Greater predictability of production times
- Significantly lower energy consumption per fixture
- Light can be controlled independent of heat
- Attractive rate of return



P.L. LIGHT SYSTEMS
THE LIGHTING KNOWLEDGE COMPANY

HSE NXT2

The HSE NXT2 1,000 Watt HPS fixture features an advanced electronic driver, cast aluminum body and high-performance reflector—delivering optimum light output and efficiencies, with years of maintenance free operation.



NEW! **HSE-NXT-LP**
Ideal for Indoor Applications!

The NXT-LP's ultra, low-profile design lends itself ideally to close-to-the-ceiling mounting, to allow for more space between the fixture and the surface of the crop in the facilities where ceiling height is limited. The NXT-LP is available in both 600W and 1000W versions, and the 1000W can accommodate both HPS and MH DE lamps.



PLX

The PLX magnetic fixture is designed for durability. Robustly engineered to stand up against the harshest growing environments, while maintaining a consistent light output for ideal results. The magnetic ballast is housed in a separate compartment from the igniter and capacitor to maximize the longevity of the internal components and assist with heat dissipation.



Reflectors

PL Light offers a choice of 8 different reflectors, designed for optimum performance across multiple applications. All our reflectors feature:

- Highly polished, miro surface material which provides a diffused light pattern
- Corrosion resistant surface which guarantees a low sensitivity to pollution
- Specially designed mounting collars provides enhanced durability and ease of maintenance

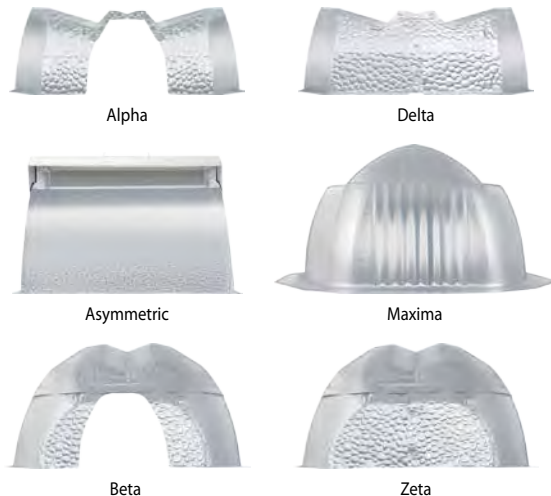

Many more lighting systems are available from P.L. Light Systems. Call your Gloeckner rep for more information and prices.



Johnson
CO₂ GENERATOR

New Listing!

Specifications	
Max. Area Fertilized Per/Unit:	4,800 Sq. Ft.
Cubic Feet/Hr. CO ₂ at 60° Temperature	72
Pounds CO ₂ /Hr.*	8.25
Burner Range Btu/Hr.*	20,000-60,000

*Based on adding 1,500 ppm CO₂ to a greenhouse with one air change per hour.

Modern growers are becoming increasingly aware of the value of CO₂ – particularly now that most greenhouses are purposely shutting out CO₂ to conserve energy. The Johnson CO₂ Generator automatically provides carbon dioxide to meet maximum growing potential and does so cost efficiently.

- *Easy and Inexpensive to Install:* No expensive ductwork is required and CO₂ is diffused evenly without the need for supplemental fans
- *Automatic and Fully Adjustable:* Units come complete with a gas pressure gauge allowing user to simply set the gas pressure desired for the greenhouse area
- *Safe:* Gas supply shuts off in case of flame failure
- *Space Efficient:* Hangs from the rafters, 18"D x 20"H; weighs just 20 lbs
- *Durable and Long Lasting:* Constructed of special heavy gauge aluminized steel

Item #	Mfr #	Description	Price (\$)
44638	EA-04-00001	No. 1332 unit with Safety Valve and Gas Pressure Gauge (natural gas)	959.00
44637	EA-04-00002	No. 1332 unit with Safety Valve and Gas Pressure Gauge (L.P. Gas)	959.00
44640	05-05-00003	Transformer (115V/24V;40VA)*	59.00
44639	SA-02-00034	Optional Control Package (automatically turns unit on/off), includes thermostat and 24 hr. timer	266.00

*Required for operation of one unit; same transformer can be used for two additional units.

One Call – Plants/Plugs, Seeds, Bulbs, and Supplies

Contact us at 800-345-3787 or www.fredgloeckner.com for additional information on the over 900 plant and plug varieties available.



DRAMM IRRIGATION SYSTEMS

LET DRAMM DESIGN AN IRRIGATION SYSTEM THAT WORKS *FOR YOU!*

For years, Dramm has been a trusted source for various irrigation components, now, Dramm not only offers those familiar items, but an impressive selection of next generation systems as detailed below. Additionally, Dramm carries all of the fittings, hoses, filters and valves to make it all work to perfection.

- Dramm in partnership with a Gloeckner representative will perform a thorough needs analysis to identify your specific requirements and to create the right irrigation system for you
- Dramm in partnership with a Gloeckner representative will offer irrigation system options that meets the criteria as determined in the needs analysis
- Dramm in partnership with a Gloeckner representative will provide the assistance as needed with the servicing of your new Dramm Irrigation System

PolyRail – Aluminum Extrusion for PE Tubing

The Dramm PolyRail elegantly supports your polyethylene tubing and can be positioned at many angles. This system is ideal for misting systems, overhead irrigation or even hanging baskets.

- Eliminates sagging of PE tubing
- Can be hung in a variety of ways
- Variety of fittings and hangers available
- Easy to install
- Great for use with the JetFog, JetRain and PCAS systems

All components required to build a PolyRail System are available as needed.

Let Gloeckner and Dramm design a system that's right for you.

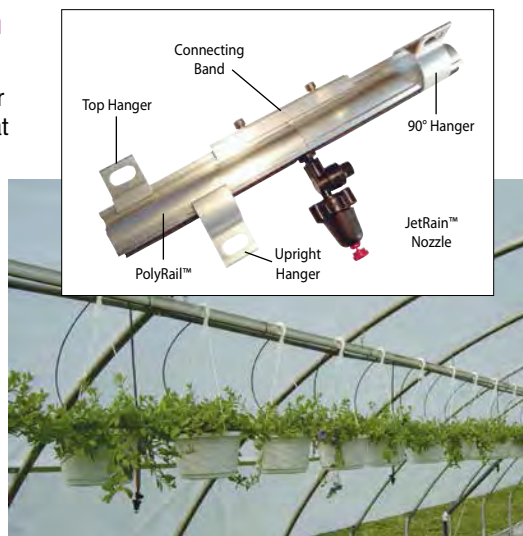

JetRain – Overhead and Mist Nozzle

JetRain Misting and Irrigation Nozzles offer even watering with a variety of flow and distance options. Designed to operate between 15-50 or 50-70psi, JetRain Nozzles are available with either a low or high pressure check valve. A variety of mounting options make the JetRain the perfect solution for multiple irrigation or misting solutions.

- Unequaled even water distribution
- Corrosion free components
- Patented nozzle design
- Anti-drip check valve

All components required to build a JetRain System are available as needed.

Let Gloeckner and Dramm design a system that's right for you.



JetFog Low Pressure Fog System

The JetFog System creates a fine fog at line pressure for cooling or humidity. With an output of 5.8 liters per hour, the JetFog produces a hollow cone of very fine mist droplets at a minimum operating pressure of 50psi. With an average particle size of 80 microns, the JetFog Nozzle is perfect for reducing the temperature or raising the humidity.

- Patented nozzle system
- Pressure compensated
- Anti-drip check valve
- Barbed or threaded connection

All components required to build a JetFog System are available as needed.

Let Gloeckner and Dramm design a system that's right for you.



PolyRail Bench Riser Irrigation Support System

The combination of the JetRain Nozzles and Dramm's patented PolyRail System provides the perfect propagation or overhead irrigation system. Designed for use with rolling benches, the Dramm Bench Riser System keeps the nozzles with the bench, ensuring that the pattern is always even, no matter where the bench is.

- Riser system moves with the bench and plants
- Various heights available
- Easy to install and modify

All components required to build a JetRain System are available as needed.

Let Gloeckner and Dramm design a system that's right for you.



Gloeckner carries the complete line of Dramm replacement parts for your existing Dramm Irrigation Systems

DRAMM WATERING TOOLS

170PL Water Breaker™

- Narrow water pattern for containers & hanging baskets
- Adjusts flow to 50% of possible volume
- Designed for low or restricted water pressures/volumes
- Professional's lightweight alternative to 170AL
- High impact cyclolac plastic and aluminum



Item #	Mfr #	GPM	Weight	Price (\$) 1-5	Price (\$) 6+
41004	170PL	7 @ 40 PSI	1.3 oz	4.25	4.00

170AL Water Breaker™

- Narrow water pattern for containers & hanging baskets
- Designed for low or restricted water pressures/volumes
- Adjusts flow to 50% of possible volume
- Cast aluminum with 3/4" brass threads



Item #	Mfr #	GPM	Weight	Price (\$) 1-5	Price (\$) 6+
41003	170AL	7 @ 40 PSI	1.6 oz	10.25	9.25

400PL Water Breaker™

- Fast, full-flow watering
- Gentle flow won't damage plants or wash away soil
- Professional's lightweight alternative to original 400 AL
- High impact cyclolac plastic and aluminum
- 3/4" hose threads



Item #	Mfr #	GPM	Weight	Price (\$) 1-5	Price (\$) 6+
41006	400PL	11.1 @ 40 PSI	1.3 oz	5.00	4.50

Now available with plastic ring. Contact us for more details.

400AL Water Breaker™

- Original professional waterbreaker
- Fast, full-flow watering
- Gentle flow won't damage plants
- Cast aluminum with 3/4" brass threads



Item #	Mfr #	GPM	Weight	Price (\$) 1-5	Price (\$) 6+
41005	400AL	11.1 @ 40 PSI	5.1 oz	15.00	14.00

750PL Lemonhead Water Breaker



The Lemonhead Water Breaker is designed to offer a lower, softer flow. Moreover, the 750PL allows for more precise watering and gives growers more flexibility in watering.



- 25% less hole surface area offers lower flow that can be regulated by a shut-off valve for minimal water and still retain a pattern

Item #	Mfr #	GPM	Weight	Price (\$) 1-5	Price (\$) 6+
51721	750PL	7 @ 40 PSI	1.6 oz	11.50	10.75

1000PL Water Breakers™

New Green and Orange!

- Softest full-flow watering nozzle available
- Waters plugs or seedlings
- Over 1000 micro-holes create an ultra-soft shower
- Will not disturb delicate soil or harm tender plants
- High impact cyclolac plastic and stainless steel



Redhead™ Model

Standard model with a *medium* pattern.

Item #	Mfr #	GPM	Weight	Price (\$) 1-5	Price (\$) 6+
41001	1000PL	7 @ 40 PSI	1.6 oz	11.75	10.50

Green Model

Perfect for *focused watering* where more control is required.

Item #	Mfr #	GPM	Weight	Price (\$) 1-5	Price (\$) 6+
51719	1000PL-N	7 @ 40 PSI	1.6 oz	11.75	10.75

Orange Model

Throws a wider pattern than the Redhead, offering the ability to cover more area with a soft, gentle flow.

Item #	Mfr #	GPM	Weight	Price (\$) 1-5	Price (\$) 6+
51720	1000PL-W	7 @ 40 PSI	1.6 oz	11.75	10.75

Seedling Nozzle™

- Water fragile plants, delicate seedlings or plant cuttings
- Produces an extra fine, hollow "Cone Mist Pattern"
- Sprays 1/2 gallon of water per minute
- 3/4" brass threads



Item #	Mfr #	GPM	Weight	Price (\$) 1-5	Price (\$) 6+
41009	510C	1/2 @ 40 PSI	2.7 oz	7.50	6.75

Brass Rose

- Extra wide spray
- Increases speed of hand watering
- Water bedding plants, pots or market packs
- Includes protective rubber guard & metric to inch hose thread converter
- 3/4" brass hose threads
- Made in Germany



Item #	Mfr #	GPM	Weight	Price (\$)
41011	540B	18-20 @ 40 PSI	8.7 oz	78.75

Brass Disconnect

- Professional quality brass quick hose connections
- Eliminates hassle of connecting & disconnecting hoses & hose accessories
- No more turning! Pull collar back to connect or disconnect
- 3/4" male & female hose threads
- Available pair, male portion (741), or female portion (742)
- Made from heavy-duty brass



Item #	Mfr #	GPM	Weight	Price (\$) 1-11	Price (\$) 12+
41062	740 (Pair)	N/A	3.7 oz	16.25	14.95
41063	741 (Male)	N/A	1.5 oz	6.75	6.00
41064	742 (Female)	N/A	2.2 oz	9.25	9.00

BRASS HOSE SWIVEL



Heavy-duty Brass Swivel is a live swivel, meaning it swivels under pressure, allowing unencumbered movement between the hose and attachment.



- Unwind hose without having to manually twist the hose
- Wands can be oriented in any direction without fighting the hose
- Brass construction is made to last; large brass nut is easy to grip and thread

Item #	Mfr #	Description	Price (\$)
50634	72700	18 GPM, weighs 6 oz	11.25

In-Line Hose Filter

- 80 mesh nylon filter eliminates nozzle clogging
- Filters unwanted dirt and debris
- EPDM foam rubber grip for comfort
- Use with Any Dramm Waterbreaker to eliminate clogs



Item #	Mfr #	GPM	Weight	Price (\$)
48176	ILF-175	N/A	.16 oz	17.75

ONE TOUCH™ HIGH FLOW™ VALVE

When Precision Counts!

The One Touch High Flow Valve offers fingertip control of your watering and allows for full flow while accommodating easy adjustment of the water flow.

- Zinc die-cast body with brass threads is lightweight and durable
- Nylon valve components ensure a long-life without leaking
- Easy slide valve for ease of adjustment and throttle
- Rubber over mold provides a soft yet firm grip
- Full water flow: 16 GPM @ 40 psi



Item #	Mfr #	Description	Price (\$)
50633	74800	Unit, weighs 9 oz	15.25

65 TOUCH'N FLO PRO TRIGGER VALVE

Utilizing specially designed valve components, the 65 will now outlast most valves on the market. In fact, testing has shown the 65 to be slightly less durable than top of the line 300 brass and aluminum valves.

- Maximized valve opening delivers higher flow (11 GPM)
- Lightweight and durable zinc cast body
- Brass threads are made to last
- Comfortable rubber molded grip
- Heavy-gauge wire latch eliminates hand fatigue



Item #	Mfr #	GPM	Price (\$)
51722	10-73065	11 @ 40 PSI	12.75

FOGG-IT NOZZLE

All brass nozzle that breaks water into a fine mist or fog-like spray.

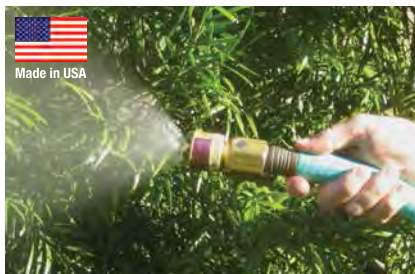

Item #	Description	Price (\$)	
		1-12	12+
41224	Superfine, 1/2 GPM	6.50	5.50
41221	Fine, 1 GPM	6.50	5.50
41223	Low volume, 2 GPM	6.50	5.50
41222	Heavy volume, 4 GPM	6.50	5.50
41225	Wide angle #2, 2 GPM	6.50	5.50
41226	Wide angle #4, 4 GPM	6.50	5.50

FOGG-IT THUMB VALVE

A gentle squeeze of the thumb lever and the water goes on, lift the lever and the water turns off.

- Constructed from chrome-plated, die-cast zinc and brass
- Compatible with 170AL water breaker



Item #	Description	Price (\$) 1-5	Price (\$) 6+
41220	Unit	10.25	8.50

GREENHOUSE SHUT-OFF VALVES

The 075 Series One-Way Ball Valve is designed for use as a one quarter turn valve for automated systems.

- One piece body construction to cover 3/4" NPT and garden hose thread end configuration application
- Rated to 125 psi and will support flow and pressure only in the flow direction
- Solid brass with Buna-Teflon pressure seals and zinc die-cast lever handle
- Maximum operating pressure – 125 psi; maximum operating temperature – 185°F; ball through diameter hole – .625"



Item #	Mfr #	Description	Price (\$)		
			1-11	12-24	25+
41502	V75	3/4" pipe to pipe	27.75	25.50	23.75
41500	S075	3/4" hose to hose	21.75	20.00	18.75
41501	V58	3/4" pipe to hose	22.95	21.25	19.75
41503	xxx	Valve Rebuilding Kits	7.25	6.75	6.25

THE ORIGINAL BONSAI WATERING NOZZLE W/PVC SHUT-OFF VALVE

This well designed item is must have for any grower's toolbox particularly those that specialize in growing Bonsai plants.

- Long-lasting high quality brass handle and chrome plated nozzle
- Features PVC shut-off valve for watering seedlings
- Removable face plate for fast and easy cleaning



Item #	Description	Price (\$)		
		1-5	6-9	10+
41046	Unit, standard 13"L	41.00	37.50	32.25
41045	Replacement Screen with Washer	5.75	N/A	N/A

DRAMM

COMMERCIAL FAN NOZZLE

Dramm's Commercial Fan Nozzle offers a fine to medium flow with a rectangular shape making it ideal for flats and seeding trays.

- Pattern does not degrade or widen at the edges of the nozzle – offering the most even flow possible
- Constructed of lightweight ABS plastic; can be used directly on the hose or at the end of a Handi-Reach Handle
- Flow rate 5-7 GPM, weighs 2.7 oz



Item #	Description	Price (\$)
49059	Fan Nozzle	5.00

BOSCH GREENHOUSE WATER SHUT-OFF VALVE

Handy valve saves water and time and is ideal for greenhouse applications. Durable valve is constructed of non-corroding, tough nylon.



Item #	Description	Price (\$) 1-24	Price (\$) 25+
41469	Unit	2.25	1.75

DGT MISTING NOZZLES

DGT Misting Nozzles are among the finest low pressure nozzles available to horticulture for irrigation, cooling and humidification.

- Made of durable PVC with stainless steel orifices and baffle pins
- Virtually maintenance free and partly self-cleaning as the pin vibrates slightly during operation
- Any soluble fertilizer may be applied through DGT nozzles; nozzle spacing 48" -60"



Item #	Description	Price (\$)		
		1-99	100-249	250+
41359	Nozzle	3.70	3.40	3.15
41358	Blue Pin only			.85
41357	Assembly Insert			.47

DRAMM METERED VALVE

- Delivers a pre-set quantity of water before shutting off
- Select variable quantities of water by turning the dial
- Available in 125 & 300 gallon maximum quantities
- No power required – perfect for outdoor use
- Available in 1" NPT

Item #	Mfr #	Description	Max Output Power	Price (\$)
48177	MTA125	0.5 - 9 gpm	125 gallons	154.00
48178	MTA300	0.5 - 9 gpm	300 gallons	154.00
48179	MT300	2.5 - 22 gpm	300 gallons	154.00
48180	MT550	2.5 - 22 gpm	550 gallons	154.00



DRAMM 360° NIFTY NOZZLE

- Overhead or on-bench water nozzle
- Designed for foliage, bedding plants, & 4-6" pots
- 10' diameter spray pattern
- 3' spacing
- Top or bottom of pipeline, or riser installation
- Use with Dramm run-out valves, no-drip risers, & no-drip extension check valves



NIFTY NOZZLE FLOW RATE IN GPM

Item#	MFR#	Color	Orifice Dia.	15 PSI	22 PSI	29 PSI	36 PSI	Price (\$)
48181	360NN-BR	Brown	1.75 mm	0.29	0.35	0.41	0.46	1.13
48182	360NN-GN	Green	2.00 mm	0.40	0.49	0.57	0.63	1.13
48183	360NN-GR	Grey	2.25 mm	0.51	0.62	0.72	0.80	1.13
48184	360NN-BL	Blue	2.50 mm	0.63	0.77	0.89	0.99	1.13
48185	360NN-RD	Red	2.75 mm	0.76	0.93	1.07	1.20	1.13
48186	360NN-OR	Orange	3.00 mm	0.90	1.10	1.28	1.48	1.13

DRAMM 360° MISTY MIST NOZZLE

- Overhead mist propagation, irrigate plugs, raise humidity
- Low to medium flow rate
- 6' diameter spray pattern
- 3' spacing
- Top or bottom of pipeline, or riser installation
- Use with Dramm run-out valves, no-drip risers, & no-drip extension check valves



MIST NOZZLE FLOW RATE IN GPM

Item #	Mfr #	Color	Orifice Dia.	36 PSI	73 PSI	Price (\$)
41370	MM-BW	Blue/White	1.00 mm	0.17	0.22	1.15
41371	MM-RW	Red/White	1.25 mm	0.25	0.35	1.15

HIGH PRESSURE MISTY MIST FLOW RATE GPM

Item #	Mfr #	Color	Orifice Dia.	73 PSI	145 PSI	290 PSI	435 PSI	Price (\$)
48187	HP-GW	Grey/White	0.75 mm	0.12	0.19	0.24	0.27	1.76

ASSEMBLY INSERT

Drill Schedule 40 PVC pipe with 29/64" drill bit. Place insert in the hole and thread the nozzle into the insert. Insert expands to wedge nozzle firmly in place.

Item #	Price (\$)
41357	.47



Quantity discounts available on all Nifty and Misty Mist Nozzles.

WATERMATICS PLUGS/QUICK-PUNCH

Tube Plugs are used to plug up holes in pipe when an error has been made or if the spacing of the tube needs to change to use existing pipe. The Quick-Punch is a gun that punches a small hole in black poly pipe that the leader tube goes into. Makes installation quick and easy.

Item #	Mfr #	Description	Price (\$)
48199	12500452	Heavyweight/Supply Tube Plugs, 100/pack	15.95
48200	12071033	Quick-Punch	16.50



PLASTIC SPIN CLEAN SCREEN FILTER

Spin Clean Filters are unique in that incoming dirty water is forced through a directional nozzle plate onto the inside of the stainless steel screen. The spinning action rotates debris down the screen wall to the large debris holding basin, debris is flushed out via a ball valve.

- Centrifugal action keeps screen clean and extends service intervals
- Plastic construction is lightweight and chemical resistant
- Two-piece threaded housing with O-Ring seal for easy maintenance



Item #	Mfr #	Size	Mesh	GPM Max	Price (\$)
41031	4EH-3/4B-150	¾"	150	9	41.00
41030	4EH-1B-150	1"	150	18	44.00
41029	4EH-1 1/2-150	1 ½"	150	55	231.25
48201	4EH-2P-150	2"	150	110	254.50

Additional mesh sizes 30, 50, 100 and 200 available upon request.

Handi-Reach™ Handle

- Eliminates stretching and stooping associated with hand watering
- Compatible with any Dramm nozzle
- ¾" male & female hose threads

Item #	Mfr #	Length	GPM	Weight	Price (\$) 1-11	Price (\$) 12+
41296	116-G	16"	N/A	4.1 oz	8.50	7.75
41297	124-G	24"	N/A	5.2 oz	9.25	8.50
41298	136-G	36"	N/A	6.6 oz	10.25	9.25
41299	148-G	48"	N/A	8.1 oz	11.00	10.00



BOOMS & BOOMERANGS

Working with Greenhouse Technology Inc. (GTI), Gloeckner can provide a full evaluation of your irrigation needs and develop and build out a Boomerang or Boom system that best fits your business.

For additional information, contact your Gloeckner representative and let's get this project "off the ground."



DRAMM DRIBBLE TUBES

Dribble Tubes provide water directly to the pot, labor costs related to watering greatly. And unlike pressure compensation drip systems, the flow rate is controlled by the diameter and length of the tubing along with the flow and pressure of the total system.



- Low-cost solution provides water directly to the pot with minimal clogging as there are no small openings to foul
- Zinc-aluminum (no lead) SlimWright™ easily slips from the pot during harvest and won't catch in the expanded metal between crops
- Best results are achieved using Dramm's Brass Eyelets and Hand Pick Tool



ON-OFF TUBE WEIGHTS

Features the exclusive on-off feature that saves water and fertilizer when part of the nursery containers are removed from the system for considerable periods of time • Ideal for hanging baskets to prevent the running of water from the overhead tubes without plant

Item #	Mfr #	Length*	Flow**	Price (\$) 100-999	Price (\$) 1,000-9,999	Price (\$) 10,000+
DTS Green, 0.045" ID/0.100" OD						
51741	DTS-12	12"	Up to 8 oz/minute	.51	.48	.45
51742	DTS-18	18"	Up to 8 oz/minute	.53	.50	.47
51743	DTS-24	24"	Up to 8 oz/minute	.55	.52	.49
51744	DTS-30	30"	Up to 8 oz/minute	.57	.54	.51
51745	DTS-36	36"	Up to 8 oz/minute	.59	.56	.53
51746	DTS-42	42"	Up to 8 oz/minute	.61	.58	.55
51747	DTS-48	48"	Up to 8 oz/minute	.63	.60	.57
51748	DTS-60	60"	Up to 8 oz/minute	.65	.62	.59
DTM Brown, 0.060" ID/0.100" OD						
51732	DTM-12	12"	4-16 oz/minute	.51	.48	.45
51733	DTM-18	18"	4-16 oz/minute	.53	.50	.47
51734	DTM-24	24"	4-16 oz/minute	.55	.52	.49
51735	DTM-30	30"	4-16 oz/minute	.57	.54	.51
51736	DTM-36	36"	4-16 oz/minute	.59	.56	.53
51737	DTM-42	42"	4-16 oz/minute	.61	.58	.55
51738	DTM-48	48"	4-16 oz/minute	.63	.60	.57
51739	DTM-60	60"	4-16 oz/minute	.65	.62	.59
DTL Blue, 0.075" ID/0.125" OD						
51723	DTL-12	12"	12-30 oz/minute	.51	.48	.45
51724	DTL-18	18"	12-30 oz/minute	.53	.50	.47
51725	DTL-24	24"	12-30 oz/minute	.55	.52	.49
51726	DTL-30	30"	12-30 oz/minute	.57	.54	.51
51727	DTL-36	36"	12-30 oz/minute	.59	.56	.53
51728	DTL-42	42"	12-30 oz/minute	.61	.58	.55
51729	DTL-48	48"	12-30 oz/minute	.63	.60	.57
51730	DTL-60	60"	12-30 oz/minute	.65	.62	.59

*Custom lengths available upon request. **Flow dependent on length and diameter of tube as well as pressure.

Brass Eyelets

Item #	Mfr #	Description	Price (\$) 100-999	Price (\$) 1,000-4,999	Price (\$) 5,000+
51740	DTMS-E	Eyelet, 0.60" and .045" ID	.029	.026	.024
51731	DTL-E	Eyelet, 0.75" ID	.031	.028	.026

Hand Pick Tool

Item #	Mfr #	Description	Price (\$)
51749	HPT	Universal Hand Pick Tool w/Brass Eyelets	11.50

Item #	Cat. #	Product #	Price (\$) 1-500	Price (\$) 501+
.036" On-Off Tube Weights				
1012126	12771012	EOW36-12	.8735	.8035
1012127	12771018	EOW36-18	.90	.828
1012128	12771024	EOW36-24	.9135	.84
1012129	12771030	EOW36-30	.94	.865
1012130	12771036	EOW36-36	.9735	.895
1012131	12771042	EOW36-42	1.15	.9325
1012132	12771048	EOW36-48	1.06	.9795
1012133	12771060	EOW36-60	1.15	1.05
1012134	12771072	EOW36-72	1.28	1.18
.050" On-Off Tube Weights				
1012135	12771112	EOW50-12	.8735	.8035
1012136	12771118	EOW50-18	.90	.828
1012137	12771124	EOW50-24	.9135	.84
1012138	12771130	EOW50-30	.94	.865
1012139	12771136	EOW50-36	.9735	.895
1012140	12771142	EOW50-42	1.15	.9325
1012141	12771148	EOW50-48	1.06	.9795
1012142	12771160	EOW50-60	1.15	1.05
1012143	12771172	EOW50-72	1.28	1.18
.060" On-Off Tube Weights				
102056	12771212	EOW60-12	.8735	.8035
102057	12771218	EOW60-18	.90	.828
102058	12771224	EOW60-24	.9135	.84
102059	12771230	EOW60-30	.94	.865
102060	12771236	EOW60-36	.9735	.895
102061	12771242	EOW60-42	1.15	.9325
102062	12771248	EOW60-48	1.06	.9795
102063	12771260	EOW60-60	1.15	1.05
102064	12771272	EOW60-72	1.28	1.18
.076" On-Off Tube Weights				
102065	12771312	EOW76-12	.8735	.8035
102066	12771318	EOW76-18	.90	.828
102067	12771324	EOW76-24	.9135	.84
102068	12771330	EOW76-30	.94	.865
102069	12771336	EOW76-36	.9735	.895
102070	12771342	EOW76-42	1.15	.9325
102071	12771348	EOW76-48	1.06	.9795
102072	12771360	EOW76-60	1.15	1.05
102073	12771372	EOW76-72	1.28	1.18

All Tube Weights sold in lots of 100.



TURBULENT TWIN-WALL DRIP IRRIGATION HOSE

Ideal for use over containers or on top of the ground for field flowers or other nursery crops.



- Over 10,000 inlet filter segments in every 100 feet of hose
- A series of inlet orifices provide double inlet protection against clogging
- Patented flow path produces a turbulent flow to reduce the possibility of clogging
- Features pressure compensation characteristics that help to even the flow rate over rough ground or for long rows
- Drops fall directly on the soil and flows in a true drip flow

Item #	Mfr #	Outlet Spacing	GPM Per/1000 Ft	Mil	Roll Length	Price (\$)/Roll
49779	11714072N	2"	2.0	10	1,000'	41.75
49780	11714070N	2"	2.0	10	6,000'	187.50
49781	11713070N	2"	2.0	8	7,500'	189.25
49782	11713071N	2"	2.0	8	3,750'	97.75
49784	11714140N	4"	1.0	10	6,000'	195.25
49785	11703322	4"	0.5	8	3,750'	93.75
49786	11703160	8"	0.65	8	1,000'	30.25
49787	11714760	24"	0.5	10	6,000'	186.50

Twin-Wall is available in many other sizes upon request.



TAPE-LOC

Tape-Loc Fittings make installation quick and easy and makes for a sure no-drip connection.

Item #	Mfr #	Description	Price (\$)
102126	12030017	Tape-Loc x 3/4" MPT Adapter ①	.73
48218	12030081	Tape-Loc x 3/4" MHT Adapter ②	.99
48219	12030022	Tape-Loc Coupling ③	.47
48220	12030131	Tape-Loc Coupling w/ Shut-Off Valve ④	5.12
48221	12030049	Tape-Loc Elbow ⑤	1.57
48222	12030092	Tape-Loc Tee ⑥	1.75
48223	12030072	Tape-Loc x 3/4" FH Swivel Tee ⑦	2.43
48224	12030053	Tape-Loc x Hose Thread Cap ⑧	.94

*In all things of nature there is something marvelous.
~Aristotle*

**1,000s of Greenhouse Grower Supplies
at www.fredgloeckner.com!**

Convenient! Comprehensive! Efficient!



With so many items to choose from, online ordering has never been so easy. We have designed our site to be simple, fast, and easy to navigate. What's more, online orders can be placed on all days, at all hours, assuring the process of executing your PO will start almost immediately.

Convenient

- Open whenever you need to buy
- Mobile friendly
- Easy search; real-time pricing

Comprehensive

- Over 5,000 items currently featured
- More products added constantly
- Cost saving sales and specials; valuable tech info

Efficient

- Complete product ordering history
- Repeat orders seamlessly executed
- Current A/P balances and past accounting ledger

**It's Safe & Easy – Register Today
at www.fredgloeckner.com!**





Great Labor Savings!

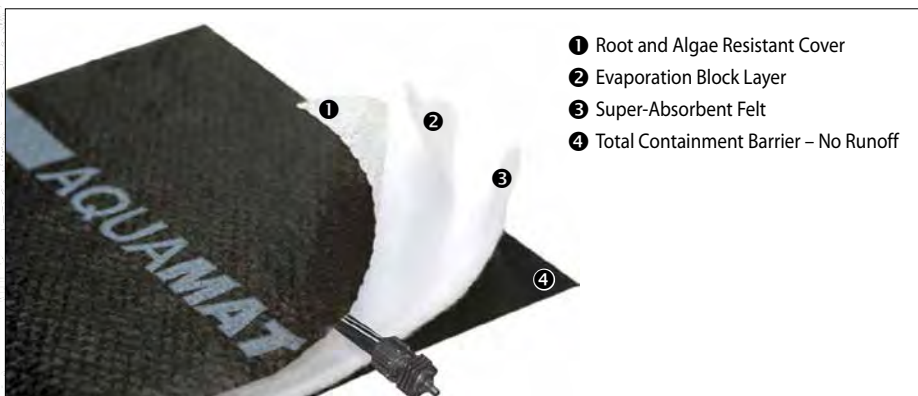

- 1 Root and Algae Resistant Cover
- 2 Evaporation Block Layer
- 3 Super-Absorbent Felt
- 4 Total Containment Barrier – No Runoff

Innovative AQUAMAT® helps today's greenhouses move towards sustainability by using 80% less water than conventional systems. The unique patented system is based on a high-performance, multi-layer textile that allows even distribution of water, prevents surface evaporation and requires considerably less water than hand watering, fixed sprinkler systems or drip irrigation. The key feature of this system is the evaporative block layer placed between the root-proof top layer and bottom layer absorbent felt. This separation keeps the top dry and stops virtually all evaporation from occurring. Also, compare to hand watering, you could expect 60% less labor expenses.

- Stops groundwater contamination by controlling run-offs
- Substantially reduces fertilizer use
- Promotes greater crop uniformity, less crop loss and increased marketability
- Allows even distribution of water to your plants while freeing workers to perform other tasks.
- Stops weed germination
- Less disease or spots foliage

Item #	Standard Widths	Custom Lengths	Price (\$)/Sq. Ft.
Inside Bench Crops			
45983	3', 4', 5', 6', 7', 8', 11'	40'-400'	1.57
	3', 4', 5', 6', 7', 8', 11'	15'-40'	1.83
Heavy-Duty Microfab Top Layer for Ground Cover			
45984	3', 4', 5', 6', 7', 8', 11'	40'-400'	1.71
	3', 4', 5', 6', 7', 8', 11'	15'-40'	1.96

Order includes integrated drip tape of 0.008" thick and 1" wide and barb driplock of 0.25" (Chapin 250 or equivalent).

Please call for system requirements, installation guide and video.

TEXEL BENCH MATTING™ AND BENCH MATTING PLUS™

Innovative Bench Matting and Bench Matting Plus from Texel provides a wealth of benefits to growers of all types and sizes.

- **Labor Savings:** Reduces the hours spent on manual watering by up to 20 times; with its ability to absorb and dispense water, Bench Matting products uniformly irrigate each plant across the entire growing surface
- **Saves Water and Fertilizer:** When watering by sprinkler, nearly 70% of water and water-based fertilizer falls between the pots, much of it seeps into the surface soil and evaporates; Bench Matting products recovers this water and effectively distributes it to plants, thus significantly reducing waste
- **Robust and Durable:** Bench Matting stands up to repeated use and harsh winters; boosts a service life of over 3 years
- **Versatile:** Can be used practically for any type of plant and even lets you rearrange pots

BENCH MATTING

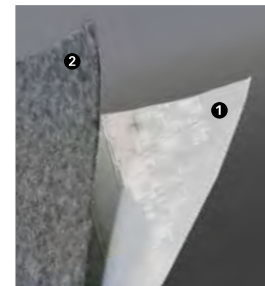

BENCH MATTING PLUS

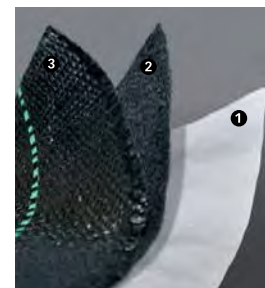

- 1 Impermeable layer underneath (not supplied by Texel, but required for a working solution)
- 2 Water reservoir made of hydrophilic nonwoven material
- 3 Texel TexPro-100 ground cover with green lines for easy pot alignment

Bench Matting

Economical solution • Polyester construction • Grey

Item #	Description	Price (\$)
47297	3' x 100'	94.25
47298	4' x 100'	126.25
47299	5' x 100'	157.75
47300	6' x 100'	189.50

Bench Matting Plus

Ideal for traffic pressure in ground application • Black with green lines at each 30 cm/12" • Polypropylene, polyester, viscose construction • UV protected • Easy to clean and handle • Good tearing and performance resistance

Item #	Description	Price (\$)
47301	3' x 100'	168.25
47302	4' x 100'	224.00
51922	5' x 100'	280.25
47304	6' x 100'	336.25



With Integrated heating tubes, the Aquathermat enhances the core technologies of the Aquamat for improved performance. Ask your Gloeckner representative for additional information.

DRAMM

COLORSTORM™ PROFESSIONAL CUSTOM RUBBER HOISING

Make your own hose lengths quickly and easily with Dramm's ColorStorm Hosing and Hose Crimper Tooling. Available as separate purchases or in handy starter kits.

ColorStorm Bulk Hose

Item #	Description	Diameter	Length	Price (\$)
49069	Yellow	5/8"	Bulk 330'	294.50
49070	Yellow	3/4"	Bulk 330'	363.75



Hose Crimper

Produces a similar fit and finish as larger hose press and factory assembled hoses • No need for ring bands or gear clamps • Easily mounts to bench or table for ease-of-use

Item #	Description	Case Pk	Price (\$)
Unit			
49060	DP-FRAME	N/A	79.00
49061	DP-J625, jaws fit 5/8" ColorStorm Hose	N/A	62.00
49062	DP-J750, jaws fit 3/4" ColorStorm Hose	N/A	62.00
Fittings/Ferrules			
49063	Male set 5/8"	12	4.10/ea
49064	Female set 5/8"	12	4.30/ea
49065	Male set 3/4"	12	5.75/ea
49066	Female set 3/4"	12	7.00/ea
49067	Splice ferrule set 5/8"	12	6.25/ea
49068	Splice ferrule set 3/4"	12	7.25/ea

Custom Home Starter Kits

Item #	Mfr #	Description	Price (\$)
51715	17626	5/8", (2) 330' hose, (1) DP Frame, (1) DP-J625 5/8" Jaws, (12) 5/8" male fittings/ferrules, (12) 5/8" female fittings/ferrules	692.50
51716	17751	3/4", (2) 330' hose, (1) DP Frame, (1) DP-J750 3/4" Jaws, (12) 3/4" male fittings/ferrules, (12) 3/4" female fittings/ferrules	869.25

DRAMM

COLORSTORM™ HOSE

Constructed of EPDM rubber for a "crackless" hose cover that is resistant to abrasion and weathering. This reinforced hose is hexagonal in shape to reduce kinking. The design of the hose allows a user to easily pull free any kinks that may occur. Our hexagonal Sure-Grip™ cover creates a softer surface for a more comfortable grip. Each hose has crush-proof, nickel plated, brass fittings for an exact fit that will survive years of use.



Item #	Description	Diameter	Length	Price (\$)
47225	Yellow	5/8"	50'	50.75
47226	Yellow	5/8"	75'	75.75
47227	Yellow	5/8"	100'	94.50
47228	Yellow	3/4"	50'	71.50
47229	Yellow	3/4"	75'	97.75
47230	Yellow	3/4"	100'	116.50

Orange, red, green, blue, and purple available upon request.



CAPMAT™ II CAPILLARY MATTING

- Made of lightweight, high-strength, non-polyester material
- Gray colored mat is resistant to rotting, shrinking, chemical decomposition and crushing
- Reversible and will not fray after cutting
- Can be used with Agribrom or Zerotel for algae control
- Highly absorbent, permits water to quickly wick to roots
- 1.0 mm mat thickness; 8.0 cm capillary lift



Item #	Description	Price (\$)
45981	4' x 100' roll	160.50
45982	6' x 100' roll	235.50

Custom sizes available, minimum quantities may apply – call for details.



CAPMAT II DISTRIBUTION KITS

- Loc sleeve header fitted with a 3/4" female hose swivel inlet, ells, tees, and fasteners, drip hose and pressure regulator
- 4' or 6' x 100 bench
- Impressive operating pressure at 8-12 PSI
- Complete directions included



Item #	Description	Price (\$)
48230	4' Distribution Kit for 4' wide Capmat II	76.25
48231	6' Distribution Kit for 6' wide Capmat II	98.75



Many New Products for 2018-2019!

Inside Front Cover, pages 92-93

BOSCH/GILMOUR FLEXOGEN HOSES

Flexogen Hoses are the standard by which all hoses are compared to in the greenhouse industry – get yours now.

- 8-ply construction – 500 psi burst strength
- Double tire cord reinforced for strength; kink resistant
- Lightweight, coils and handles easily
- Flow Guard Plus protective collar on 5/8" and 3/4" hoses resists kinks at faucet
- Heavy-duty, crush resistant, Full Flo machined metal couplings on selective sizes
- Polished surface resists minor abrasions, stains, and mildew



Item #	Mfr #	Description	Price (\$)
41250	10-58050	5/8", 50'	36.50
41251	10-58075	5/8", 75'	51.00
41252	10-58100	5/8", 100'	64.50
41246	10-34050	3/4", 50'	53.00
41247	10-34075	3/4", 75'	77.25
41248	10-34100	3/4", 100'	103.50



HI-HOSE WATERING SYSTEM

- Keeps watering hose off of the floor and out of the way
- Turnkey system is labor-saving and cost efficient
- Kits available for 50', 75' and 100' greenhouses
- Hundreds of systems successfully being used globally

Item #	Description	Price (\$)
48232	50 ft kit	169.00
48233	75 ft kit	240.00
48234	100 ft kit	330.00

Each Kit Includes: Coupled 5/8" "Blue Ribbon" hose with anti-kink hangers preinstalled, swivel pulleys, galvanized aircraft cable, wire rope clamps, and a turnbuckle. *Assembly instructions included.*



NOVA 1626T 6-ZONE MIST CONTROLLER

- Sturdy non-metallic enclosure protects against UV rays and resists moisture and chemicals
- Seconds on, minutes off settings
- 1x, 2x, 3x time extender toggle switch
- One easy connection for the common wire
- 24 hour digital clock, with 9 programmable events to turn controller off
- 1 year warranty



Item #	Description	Price (\$)
48235	Unit, includes 24VAC plug-in transformer	639.75



TRIDENT – T3A SINGLE ZONE MIST CONTROLLER

- Sturdy non-metallic enclosure, UV protected, resists moisture and chemicals
- Toggle switch to select ON/OFF time mode, second/minute, minute/minute, and minute/hour
- 2 to 60-second or minute ON time, and 2 to 180-minute or hour OFF time
- Extra bright LEDs show ON/OFF times when programming and controller are in use



Item #	Description	Price (\$)
48236	Unit	310.25

Gloeckner Cares!



WATER PLUS VPD MISTING & WATER CONTROLLER

- 12 independent stations can each be set individually for operation times, watering days, and repeat functions
- Continuous vapor pressure deficit adjustments
- User sets the ON time – seconds or minutes
- The controller determines the off time based on current conditions and VPD value set
- Features night watering disable functions



Item #	Description	Price (\$)
48237	Unit, includes 24V transformer and power cord (24VAC output)	1,348.75



ELECTRONIC LEAF *Ideal for Mist Cuttings!*

- Works on the principle of evaporation; weight of mist on the metal screen controls solenoid operation
- Housing made with durable stainless steel
- Features solid state internal components with no hazardous materials
- Green LED light indicates power is provided to the electric leaf; Blue LED light indicates power is supplied to the solenoid valve
- 24 volt output, 40 VA, 120 volt in
- 24-volt plug-in transformer with 10' cord
- 20' of 18/2 wire for solenoid valve connection also included



Item #	Description	Price (\$)
41349	Unit	275.75

DRAMM

MIST TIME™ CONTROLLER



The Mist Time Controller is perfect for time or temperature-based control of misting valves. With the ability to program each valve independently, the Mist Time offers unmatched flexibility.

- Program each valve independently, controller can operate as a time-based mist controller, pulse-irrigation controller, and a mist cooling controller simultaneously
- Different operation modes work on time, temperature, or both
- Text interface is easy to program
- Pump prestart option
- NEMA 4 housing is durable and water resistant; easy to wire and install

Item #	Mfr #	Description	Price (\$)
51718	MT-10	Unit	849.00

DRAMM

RAINPRO™



- Flexible irrigation controller
- 3-valve base unit – add up to 15 outputs
- Water-tight enclosure
- Water budget feature
- Rain sensor available
- 120V AC power source, 24V AC power output

Item #	Mfr #	Description	Price (\$)
48242	RPIC-03	3-valve	160.00
48243	RPIC-07	7-valve	190.00
48244	RPIC-11	11-valve	224.00
48245	RPIC-15	15-valve	259.00

DRAMM

AUTOVALVE™/MIST AUTOVALVE™

- 9 volt battery operated single valve
- Includes valve
- Three modes: single start, start on select days, up to three start times/day
- Watertight enclosure
- Great for landscaping, outdoor crops or temporary irrigation systems



Item#	Mfr #	Size	Price (\$)
48240	GVMB075	¾"	165.00
48241	GVMB100	1"	165.00

IRROMETER

The IRROMETER operates on the tensiometer principle, which is entirely different from other systems which measure percent of moisture. The IRROMETER consists of a sealed water fill tube equipped with a special vacuum gauge and with a porous ceramic tip that is installed in the ground at the desired root zone depths. In dry soil, water is drawn out of the instrument, reducing the water volume in the instrument and creating a partial vacuum which is registered in the gauge. The drier the soil, the higher the reading, and irrigation will reverse this action. The vacuum created by dry soil draws water back into the instrument from the soil, which in turn results in a lower gauge reading.

The instrument is in effect a dummy root system equipped with a gauge that continuously registers "how hard the roots are working." A gauge reading of 50 indicates that the roots are extracting the same amount of moisture whether the crop is planted in sandy or clay soil.

With each initial order, a Service Unit is required. The primary component in the Service Unit is the Hand Vacuum Pump, used to evacuate all air from the instrument either before installation of in the field thus insuring maximum accuracy and sensitivity at all time.



Service Unit

- Recommended for general use in most soils with row, field and tree crops managed between 10-80 cb (kPa)
- No calibrations are necessary under normal operating conditions
- Hand Vacuum Pump is constructed on durable anodized aluminum

Item #	Description	Price (\$)
41505	Model 106, 6"	78.50
41506	Model 112, 12"	82.00
41507	Model 118, 18"	85.25
41508	Model 124, 24"	88.50
41509	Model 136, 36"	95.00
41510	Model 148, 48"	101.50
41511	Service Unit, includes hand vacuum pump, 25 monthly chart forms, 1 bottle IRROMETER fluid	56.00



ASCO SOLENOID VALVES AND ACCESSORIES

Two-way packless valves are ideal for normally closed operation, (valves closed when de-energized, open when energized).

- Full port opening with snap action
- Monel coil, brass body, stainless steel springs and copper shading coil, core tubes core and plugnet
- Standard voltages – 24, 120 A-C, 60 cycle

Item #	Description	Item #	Description	Price (\$)
2-Way Valve – 24V/60 Cycle, 120V/60 Cycle*				
41035	½" – 11W, 24V	41036	½" – 11W, 120V	107.50
41037	¾" – 11W, 24V	41038	¾" – 11W, 120V	126.75
41034	1" – 6W, 24V	41033	1" – 6W, 120V	177.75
Valve Replacement Coil*				
41553	½", 24V	41556	½", 120V	86.50
41553	¾", 24V	41556	¾", 120V	86.50
41555	1", 24V	41554	1", 120V	77.75
2-Way Rebuilding Kit				
41557	½"			114.00
41557	¾"			114.00
41558	1"			134.00

*Please specify voltage when ordering.
The full-line of ASCO Solenoid Valves are available upon request.



PVC SOLENOID VALVE

High-strength, non-corrosive valves are recommended for irrigation applications in all climactic conditions.

- Diaphragms are constructed of a tough nylon reinforced BUNA-N rubber
- Can be easily installed in any position above or below ground and are easily maintained
- Electrically operated valves, 2-watt solenoid are of normally closed design
- Features a metering rod for self-cleaning; slow opening and closing to reduce water damage to piping



Item #	Description	Price (\$)		
		1-10	11-19	20+
46517	24volt, A-2500TF	26.25	24.25	22.50
Item #	Description	Price (\$)		
41472	Reducing Adapter, 1" x ¾"	.85		

Solenoid valves should be used exclusively for irrigation, not misting systems.



Since 1973, Agra Tech has been delivering extraordinary greenhouses that offer competitive advantages to growers of all sizes, across the country. In fact, Agra Tech has consistently proven to help growers cut operating costs, enhance crop quality and increase productivity – all by selecting the best fit Agra Tech Greenhouse for their business.

- Agra Tech manufactures many greenhouse designs for precise environmental control to shade houses and tunnels and protect your crop and extend your growing season
- Agra Tech's natural ventilation, curtain, and benching systems improve energy and efficiency of your greenhouse
- Service is a hallmark of Agra Tech, from a thorough needs evaluation, through construction and everyday maintenance and troubleshooting



SOLAR LIGHT CLEAR SPAN TRUSS GREENHOUSE

The Solar Light is well known for its value in high volume production facilities. It is the best house for valuable crop production and is used extensively for propagation, research and development, education and retail installations.

- 6:12 roof pitch: Causes condensation that forms on the inside of the roof panels to run down the panels rather than drip onto the crop; increased air mass in the roof keeps the temperature inside the greenhouse cooler in the summer and more stable all year; tall peak makes the Solar Light roof vent very effective at venting the hot air out of the greenhouse
- Solar Light is a “Dry House”: Roof system collects condensation from the inside of the roof and channels it outside the greenhouse, not on your plants; the purlins have a specially formed channel to collect the condensation, from there, the water drops to the special “v” in the top chord and travels down into the gutter
- The Solar Light has the room and strength to take advantage of all the labor and energy saving innovations available: Energy curtains, watering booms, lighting, heating, vent equipment, benching, and transportation systems
- Widths: 18', 24', 30', 36', 42', and 50'; Eave Heights: 8', 10', 12', and 14'
- The Solar Light meets International Building Code (I.B.C.) requirements; Structures are available in agricultural or non-agricultural (i.e. commercial, school, retail) loadings



Specifications	
Standard I.B.C Roof and Wind Loads	12 (live)/85 (wind) C (exposure) AG or 12/90C/35 (snow) # AG; many other load variations available
Columns	Sidewall = 4" SQ. (minimum or 13ga) 12' on center; Interior = 2 7/8" or 2 3/8" diameter, 12' or 6' on center interior (depending on load requirements)
Trusses	12' o/c bolt together
Gutter	11" wide x 5" deep (minimum of 16ga)

For product and pricing information for these or any of the Agra Tech Greenhouses, call the Greenhouse System Design Team direct at 800-345-3787.



RACK & PINION VENTS

Features continuous hinged windows operated by an internal steel rack and pinion drive system. Additionally, the vent may be driven by a chain operated manual gearbox or by an automated vent controller.

- Aluminum extruded hinge, top rail, bottom rail and headers
- Steel rack & pinions 6' on center, strong enough to hold up glass spaced 10' on center
- Shaft hangers with Nylatron bearings;
- 1 3/8"D, 13 gauge drive shaft
- Best possible weather seal (3 points)
- Easy to install

Available for:

- Peak Vents on the Solar Light, Continental and North Slope Greenhouses
- Gutter Roof Vent for the Insulator Greenhouse
- Wall Vents – inside lifting for sides and ends
- Pad Vents – outside lifting for over pad cooling



A capital investment of this nature should be made with great care. Budget, space, plants, weather, ventilation and many more issues need to be evaluated to ensure the best fit greenhouse is purchased for your business. That's why Gloeckner has instituted in conjunction with Agra Tech, the *Greenhouse System Design Team* that offers a complimentary needs analysis and subsequently provides practical greenhouse recommendations that are the best fit for you. In addition, the *Greenhouse System Design Team* will assist you with all steps of the build-out, to everyday maintenance and troubleshooting. Call the Gloeckner *Greenhouse System Design Team* direct at 800-345-3787 for a full evaluation of your needs.



2131 Piedmont Way, Pittsburg, CA 94565
www.agatech.com

Best Value for Dollar Spent — Best Technical Competence
Best Knowledge of Sales Staff — Best Overall Reputation
Best Innovation in Design — Best Service

For product and pricing information for these or any of the Agra Tech Greenhouses, call the Greenhouse System Design Team direct at 800-345-3787.



CONTINENTAL COMMERCIAL GREENHOUSE

Available in 2 Widths – 31'-6" and 39'-4"

Agra Tech's Continental Greenhouse is a Gothic gutter connect structure that can be covered with poly, 8mm twinwalled polycarbonate or corrugated polycarbonate. A ridge vent can be added to provide excellent natural ventilation whether the roof is covered with poly or polycarbonate. Extra large gutters add strength and carry 60% more runoff away from the greenhouse.

You may recognize the name "Continental" that has been absent for a while from our line. Well it is BACK and updated to meet today's new demands. The roof pitch has been lowered just enough to reduce the new IBC wind loads on it, but it still does a wonderful job of natural ventilation and keeping your crops cool below. The bottom chord will be flat (of course unless you want it arched). Curtain can be flat at the bottom chord or slope-flat-slope.

"In the winter, our climate can be really challenging – winds in excess of 90 mph and snowfall. We have had 2-3' of snow in the gutters and they have stayed strong – no bowing or bending. These houses are steady as a rock." (Bowdoinham, ME)

"I have two Continental houses and they have the best growing environment of any greenhouse I have ever been in." (Watsonville, CA)



A Greenhouse for Every Need and Application!



Refer to pages 84-90 for complete information and reference photos.



THE INSULATOR GREENHOUSE SERIES

The Insulator is a versatile and affordable greenhouse for those who want double poly in a gutter connected range. The Insulator can be used as a simple poly structure or outfitted into a high-tech growing system.

- Strong greenhouse that meets most building codes
- Easy to lay out the interior for good space utility and crop movement; has crop hanging capabilities
- Any crop that grows well under poly will thrive with The Insulator
- Roof purlins catch condensation and channel it to the gables before it drips reducing damage to foliage or planting material
- Outfitting with any combination of Roll-a-Roof, roof vents, energy curtains, opening sides, fan and pad cooling, and heating provides unprecedented control over the environment
- Available in 18', 21', 24', 27', 30', and 35' widths and lengths in multiples of 12'

Specifications	
Roof & Wind Loads	10/70B, 20/90B standard; UBC, IBC; Designed to spec
Columns	4" sq. or 4"OD, 12' on center for sidewall; 2 7/8" or 2 3/8" diameter, 12' or 6' on center interior
Arches	1 5/8" to 2 3/8"OD, 6' on center
Bottom Chords & Webs	1 3/8" - 1 7/8" OD, 12' on center (6' o/c optional)
Eave Heights	8', 10' and 12' standard, other sizes available upon request



For product and pricing information for these or any of the Agra Tech Greenhouses, call the Greenhouse System Design Team direct at 800-345-3787.



THE NORTH SLOPE GREENHOUSE

The North Slope is designed to shed snow and allow maximum light into the greenhouse for Northern climates. Additionally, its generous peak makes it easy to cool with natural ventilation so that it excels in mild and hot climates as well.

- **Strength:** The North Slope's unique arch design with no flat spots is stronger and drips less
- **Ventilation:** The North Slope can be fitted with a ridge vent; Optioned with roll-up or drop walls on the sides, the North Slope is an excellent candidate for natural ventilation
- **Hard or Soft Coverings:** The North Slope's flexible design can be covered with hard coverings such as twin walled or corrugated polycarbonate or with soft coverings like poly, shade cloth, or insect screen
- **Code or Non-Code:** The North Slope meets building codes, however, it may be purchased without the tie rods and webs as non-code

North Slope 24

U.B.C. 25# ground snow/90mph exposure B wind load (4' arch spacing with tie bars and webs) • 12# live load and 85mph exposure C wind load (6' arch spacing with tie bars and webs)

Specifications	
Arches	2 3/8" OD 16 ga, 6' or 4' on center
Condensate Controlling Roof Purlins	5-18 ga for poly roof; 6-16 ga & ridge tree for rigid roof
Stubs	2 3/8" OD 16 ga, 6' or 4' on center

North Slope 30

30# ground snow load 100mph exposure C wind load (4' arch spacing with tie bars and webs) • 12# live load and 90mph exposure C wind load (6' arch spacing with tie bars and webs)

Specifications	
Arches	2 3/8" OD 11 ga, 6' or 4' on center
Condensate Controlling Roof Purlins	5-18 ga for poly roof; 6-16 ga & ridge tree for rigid roof
Stubs	2 7/8" OD 12 ga, 6' or 4' on center

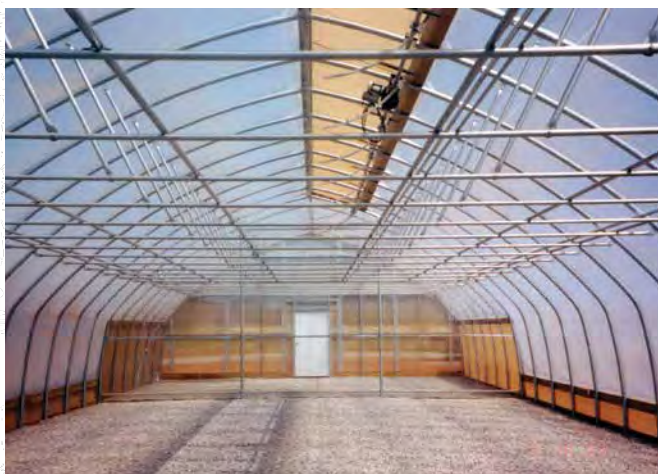

For product and pricing information for these or any of the Agra Tech Greenhouses, call the Greenhouse System Design Team direct at 800-345-3787.



THE COLD FRAME GREENHOUSE

The Economical Choice!

The Cold Frame Greenhouse is best suited for over-winter crop protection for starter houses for new growers. Additionally, The Cold Frame assembles in a snap with the help of an easy to follow instruction booklet.

- Features all galvanized structural steel components
- Easy assembly – holes are pre-drilled, fasteners are included
- Economical over wintering frame – used year round by many growers
- One condensate purlin comes standard with each house

Cold Frame 16

Available in 4' or 6' on center spacing

Cold Frame 20

Arches and stubs are available with 4' or 6' on center spacing • Stubs available in 4', 5', or 6' nominal heights, with an 8'6", 9'6", or 10'6" overall peak heights • Standard structure braces are included – 1 3/8" pipe brace at corner columns, 1 3/8" pipe brace at endwall columns

Endwall Framing Set for poly, twin-wall polycarbonate, or corrugated polycarbonate are available upon request.



For product and pricing information for these or any of the Agra Tech Greenhouses, call the Greenhouse System Design Team direct at 800-345-3787.



DROP WALL VENTILATION SYSTEM*

The Drop Wall provides maximum sidewall natural ventilation to reduce inside temperature and introduce fresh outside air. Drop walls introduce cool air from the eave and may also be used for air pruning or crops.

- Opening from the eave to grade, the Drop Wall aids in the evacuation of heat from upper areas of the house
- Crop roots are not subjected to cooler air immediately
- The Drop Wall can be used for air pruning and access to the crop from the sidewall
- Steel aircraft cable with steel pulley system operates the wall
- Walls can be manually or motor driven – computer control of motor driven wall is optional
- Lengths available up to 240' long; height to 12' tall



ROLL-UP WALL VENTILATION SYSTEM*

The Roll-Up Wall provides maximum sidewall natural ventilation to reduce inside temperature and introduce fresh, outside air. Roll-Up Walls introduce cool air from the ground level and are the most cost effective.

- Opens from grade to eave up to 240' long
- 8' or taller has a center shaft, it opens twice as fast and is more stable in windy conditions
- Retainer bars keep wall in place, 1 3/8" pipe for 8' or taller, cable for quonsets
- Can be used as interior roll up for partition wall
- Agra Tech Roll-Up is adaptable to existing greenhouses to provide cross ventilation
- Walls can be manually or motor driven – computer control of motor driven wall is optional



*Shaft Cap Extrusion is used on both the Drop Wall and the Roll-Up Wall. This allows the poly to be changed without disassembling the wall.

If you don't see the greenhouse you're looking for or require a customized solution, call the Greenhouse System Design Team now.



AGRA BENCH SYSTEMS

Attain maximum flexibility and square footage efficiency with Agra Tech's Bench Systems. Benches are typically topped with 3/4", 13 gauge expanded metal that has been hot dipped after expansion for maximum service life.

Rolling Benches

Unique rolling benches have wider aisles to move crops faster and allow better access for workers and carts.

- Unique bench stop/keeper feature prevents the rolling top from tipping while maintaining structural integrity
- The peaked roll bars allow easier and smoother rolling; the peaks prevent soil, chemical and water build-up that can otherwise interfere with or corrode flat roll bars
- Holds a 200 lb concentrated load on the cantilevered section

Rolling Bench Aisle Widths with Operating Load
5'0" Bench = 18" aisle and 13#/sq. ft.
5'6" Bench = 21" aisle and 12#/sq. ft.
6'0" Bench = 24" aisle and 11#/sq. ft.
6'6" Bench = 27" aisle and 10#/sq. ft.

Stationary Benches

Stationary Benches are designed to meet the highest expectations in strength, durability, and ease of construction.

- Benches are quality constructed with galvanized steel 1 1/2" wide cross bars, 2" ID
- "U" shaped legs, and break formed Z-runner's which run the length of the bench and are point fastened to each bench leg
- Side rails and end rails can be either steel or aluminum

Stationary Bench Widths and Load
3'0" = 22#/sq. ft.
4'0" = 16#/sq. ft.
5'0" = 13#/sq. ft.
5'6" Bench = 12#/sq. ft.
6'0" Bench = 11#/sq. ft.
6'6" Bench = 10#/sq. ft.

Mobil Tray, Ebb and Flow, Caster and T-Rail Benches available upon request.

The following options are available for Agra Bench Systems including: Stabilizer Assembly, Leg Anchors, Under Bench Heating Supports, Retro-Fit, Expanded Metal, and more. Call the Greenhouse System Design Team for more information.

For product and pricing information on any Agra Bench System, call the Greenhouse System Design Team direct at 800-345-3787.



A-V BENCH TOPS

If you have the benches pre-made, we have the right tops to complete your benches. Select from the two convenient sizes below and build your bench system today.

- Polypropylene tops resist weathering, will not rust or decay, are corrosion resistant and UV protected
- Inhibits mold and fungus growth
- Non-conductive
- Easy to clean and assemble

Item #	Description	Price (\$)
43416	18" x 36"	9.25
43417	24" x 48"*	14.50

*Larger size model accommodates tubular heating systems.



FIBERGLASS BENCH FRAMES

A-V offers a complete line of fiberglass bench frames. Models include multi-tier and rolling designs with fixed, folding or removable legs. Call your Gloeckner Greenhouse System Design Team for expert assistance in developing the right solution for your bench system needs.

Please call for product and pricing information.





Attko
Greenhouse, Inc.

Attko Greenhouse is a dynamic company with over 30 years of experience, offering a fresh and distinctive view on greenhouse construction. Attko offers a full scope of gutter connect “Venlo” Wide Span and “Open Roof” greenhouses, all of which can be completed with shade/heat retention systems, unit heaters, or hot water heating systems. Additionally, Attko is prepared to satisfy simple requests through sophisticated turnkey projects.

- Custom engineered to the specific needs of the grower, crop, and local climate
- Hands-on technical assistance to assure the customer selects the solution that best improves their cost efficiency and crop quality
- Greenhouse systems are built to be an excellent investment for years to come



OPEN ROOF GREENHOUSE SYSTEMS



New Listing!

The best of both worlds! Attko's Open Roof Greenhouse takes natural ventilation to the extreme and allows for maximum control of humidity and ambient temperature. This design offers full plant exposure to natural light entering the greenhouse and is ideal for hardening your crops. What's more, when the roof is closed, it offers the same plant protection and environmental control you would expect from a standard greenhouse.

- Standard roof spans are 21'0", 26'3", 31'6", and 42" widths with bay increments of either 10' or 13'
- 100% roof opening is accomplished through continuous vents along the length of the greenhouse that open from the ridge and hinge at the gutter
- Tubular roof subframes in combination with heavy-duty steel rack & pinion drives ensure exceptional storm resistance
- Aluminum extruded gutter hinge profiles feature contact design and control condensation water run-off; aluminum extruded gutters with an integrated hinge are available upon request
- Glazing options include tempered glass, diffused glass, or polycarbonate panels

Please call for a thorough evaluation of your needs and custom pricing.





Attko
Greenhouse, Inc.



VENLO STYLE GUTTER CONNECT GLASS GREENHOUSE SYSTEM

New Listing!

Attko's Venlo Gutter Connect Greenhouse System, with its self-supporting glass roof in combination with standard spans and bay dimensions, is *the most affordable glass greenhouse on the market today.*

- Standard roof spans are 21'0", 24'0", 26'3", 31'6", and 42" widths with bay increments of either 10' or 13'
- Stellar flexibility to accommodate the various types of growing systems available in today's market
- Extruded aluminum roof and wall glazing systems are highly storm resistant; each extrusion is designed for its own specific application and usability
- Pre-fabricated steel components are manufactured with great precision, reducing construction time
- All bearing members are hot-dipped galvanized after fabrication, ensuring long-lasting use
- Roof ventilation options are available from 20%-50% of the roof opening, as well as various sidewall ventilation and cooling installations
- Simple installation; requires minimal maintenance
- Glazing options include tempered glass, diffused glass, polycarbonate, or insulated sandwich panels

Please call for a thorough evaluation of your needs and custom pricing.





SOLAR-STAR QUONSET STYLE GREENHOUSE *New Listing!*

- 17', 20', 22', and 26' widths
- 1.660" OD 14-gauge galvanized pipe; .083" wall thickness on rafters and posts
- 4' rafter spacing
- Gable frame brackets, assembly hardware, and bolts for baseboards included
- 1 ridge, pre-drilled 4' on center included
- 2 purlins and gable end wind bracing included on 20' and larger models



SOLAR-MATE QUONSET STYLE GREENHOUSE *New Listing!*

- Available in 17', 20', 22', and 26' widths
- 12', 14', and 17' models feature 1.315" OD x .058" wall, 17-gauge galvanized pipe rafters and 1.660" OD x .083" wall, 14-gauge galvanized pipe posts
- 20' wide model features 1.660" OD x .06" wall, 16-gauge galvanized pipe rafters and posts
- Standard 4' rafter spacing on all models; includes ridge, pre-drilled 4' on center
- Gable frame brackets included



Please call for a thorough evaluation of your needs and for custom pricing.



NORTHERN STAR GOTHIC STYLE GREENHOUSE *New Listing!*

- Available in 17', 21', 25', 28', 30', and 34' widths
- 1.900" OD 13-gauge galvanized pipe, .095" wall thickness on both rafters and posts on the 28', 30' and 34' models
- 1.660" OD 14-gauge galvanized pipe, .083" wall thickness on both rafters and posts on the 25' model only
- 1 ridge, pre-drilled on center standard all models; 4' rafter spacing standard
- 2 purlins included on most models
- Can accept polyethylene or polycarbonate covering
- Gable frame brackets, gable end wind bracing, assembly hardware, and bolts for baseboards included



CLASSIC GUTTER CONNECTED GREENHOUSE *New Listing!*

Available in 18'-21', 24'-27', and 30' Wide Models!



POLARIS PREMIUM GUTTER CONNECTED GREENHOUSE *New Listing!*

Available in 18'-21', 24'-27', and 30' Wide Models!



Please call for a thorough evaluation of your needs and for custom pricing.



Free-Standing



Gutter-Connect



Curtain Wall

GREENHOUSE VENTILATION CURTAINS

- Enables the widest opening for ventilation across the shortest greenhouse dimension
- Available as two-layer poly with independent inflation system providing superior insulation

Free-Standing Packages

Designed for curved structure profile like hoop houses and high tunnels • Best ventilation efficiency, best ventilation value • Lowest ventilation energy consumption

Please contact your Gloeckner representative for a thorough evaluation of your needs and pricing information.

Gutter-Connect Packages

Designed for straight sidewalls, end walls and evaporative pad systems • Improves roof vent efficiency • Much greater opening, much greater clearance than hinged vent systems

Curtain Wall Packages

Create inviting access for your customers • Convenient thoroughways for material and product movement • Partition sections of your greenhouse for multiple uses

MANUAL CURTAIN OPERATORS

The ideal choice for growers who want to keep operations simple and manage costs.

- Ideal for curtains up to 240' x 5'H
- 13:1 manual gear crank
- Can be used in right or left direction
- Stays attached to Roll-Bar and is held at the desired height by internal brake



Crank Handle Accessories

- Adapters
- Guide Pipe Hardware
- Crank Handles



Item #	Mfr #	Description	Price (\$)
51693	63-GC13-1	13: 1 ratio Gear Crank with guide wheels	145.00
51694	63-GC13-12DSH	13: 1 2D ratio Gear Crank with guide wheels and short handle	195.00

Item #	Mfr #	Description	Price (\$)
51695	65-RBA12-1.3	Roll Bar Adapter, 1/2" square shaft adapts to 1.315" od (1.158" id) roll bar	24.00
51706	65-RBA12-SC	Roll Bar Adapter, 1/2" square shaft adapts to Side Clasp (1.25" SQ) roll bar	38.00
51696	71-GP7A	Guide Pipe Assembly 7' long, w/ chain link hanger	32.50
51708	64-CH2	Crank handle 24" long, with hook for loop input gears	19.00
51697	64-DC2	Drill Crank handle 24" long, with hook for loop input gears	24.00

Volume Discounts Available Upon Request.

ADVANCING ALTERNATIVES **LOW VOLTAGE MOTORS**

- Provides motorized power for greenhouse ventilation curtains
- Single shaft motors are available in 60 NM, 100 NM & 180 NM; Double shaft motors are available in 100 NM and 200 NM
- Available with adapters based on many roll bar diameter/types



Single Shaft Low Voltage Motors

24VDC • 40 rotations

Item #	Mfr #	Description	Price (\$)
51698	61-LVM60-GW	60NM Low Voltage Motor with guide wheel set	275.00
51699	61-LVM100-GW	100NM Low Voltage Motor with guide wheel set	350.00
51700	61-LVM60	60 NM motor only, 20 mm OD single output shaft	225.00
51701	61-LVM100	100 NM motor only, 20 mm OD single output shaft	250.00

Low Voltage Motor Adapters

Adapters fit 20 mm shafts – used for Low Voltage Motors above



Item #	Mfr #	Description	Price (\$)
51702	65-RBA20M-1.3	1.3" (1.158" round) for 60 & 100 NM Motors	10.00
51703	65-RBA20M-SC	Side Clasp (1.25" SQ) for 60 & 100 NM Motors	26.00



VCU2-24



VCU4-24



Aegis TEC



Aegis TEC Plus

Vent Control Units 2 Year Limited Warranty

- Ideal for the unique challenges of greenhouse ventilation
- Control up to 2 or 4 curtains and 2 individual dry contact devices (heaters, fans, etc.)
- Adjustable open and close temperature • Effective temperature compensation
- Optional sensor overrides (unit specific) • Touchscreen & LED digital display, status of operations
- Quick and easy programming; holds program in power outage

Item #	Mfr #	Description	Price (\$)
49854	41-VCU2-24	Vent Control (for 2 24VOLT motors), thermostat, 100' sensor, staged timing, Prewired Box, 24 Volt Transformer, DC Diode, switching relays	850.00
49855	41-VCU4-24	Vent Control – operates four 24VDC motors, includes manual overrides, LED display, 100' temp probe (rain or humidity sensor purchased separately)	1,500.00
51704	41-AEGISTEC	Aegis TEC. Touchscreen thermostatic/timed management of 1 ventilation zone with heating and cooling outputs. Humidity, rain and wind overrides available.	1,250.00
51705	41-AEGISTECP	Aegis TEC Plus. Touchscreen thermostatic/timed management of 2 ventilation zones with heating and cooling outputs. Humidity, rain and wind overrides available.	1,850.00



POLY-VENT NATURAL VENTILATION SYSTEM

Growers with all styles of greenhouses and crops have found this system to be a better alternative to expensive rack and pinion vents and leaky roll-up curtain systems. The new frame has improved water drainage and is now designed to be mounted to most greenhouse sidewalls without modification. Poly-Vent operates using only small blowers that can be thermostatically controlled. Single-stage allows you to fully open or close off your ventilation and two-stage gives you the ability to select different temperatures at which the top and bottom will open or close. When fully inflated, the dead air also acts as an insulator. Available in 24", 36", 48" and 60" heights.



- **Thermostatically Controlled** – Single-staged or two-staged automatic temperature control for optimal control
- **Rugged Construction** – Built tough with a 24-gauge galvanized frame for years of use
- **UV-Stabilized 4-Year Poly** – Clear, long-lasting poly provides excellent light transmission



Poly Vent Tubing Replacement Plastic

Item #		Nominal Size	Working Height	Price/Linear Ft. (\$)
Poly Vent II	Poly Vent III			
44915	44918	3' x 350'	24"-36"	3.80
44916	44919	4' x 350'	34"-46"	4.25
44917	44920	5' x 350'	46"-58"	5.35

Note: \$15 cut charge if less than stock roll. \$32 to cut and seal both ends.

Poly Vent W/Frame Assembly

Item #		Nominal Size	Price/Lineal Ft. Including Frame (\$)		Complete Ends/Pkg-Price Ea. (\$)	
Poly Vent II	Poly Vent III		Poly Vent II	Poly Vent III	Poly Vent II	Poly Vent III
44921	44922	3'	12.75	13.45	282.00	431.00
44923	44924	4'	13.45	14.55	289.00	447.00
44925	44926	5'	14.85	15.95	304.00	462.00

Accessories

Item #	Description	Price (\$)
44906	PT2448 Blower	124.00
44912	3"D, 5' Flex Tubing	16.00
44907	Air Transfer Gasket	.95
44910	Cut & Seal Charge, non-standard lengths	32.00
44911	Cut charge on non-standard lengths	15.00



THREE LAYER GREENHOUSE FILMS

Established in 1985, Poly-Ag Films has become Israel's leading producer of horticultural films and a major supplier to the North American and international markets. Poly Ag's Israel and Mexico based facilities include some of the most advanced multi-layered extruders in the world. These extruders have exceptionally high accuracy levels as well as computerized control interface. What's more, the data entry layouts for the extruders are completely computerized, preventing errors and omissions in the composition of materials. All production is operated by Poly-Ag's highly skilled and experienced production team.



SUNVIEW 4 CLEAR – 6 MIL

- Durable • Excellent top layer performance • 90% light transmission • 25% light diffusion • Superior puncture resistance
- UV stabilized for up to 4 years

Item #	Width	Length	Lbs/Roll	Price (\$)/Roll		Item #	Width	Length	Lbs/Roll	Price (\$)/Roll	
				Under 3,000 lbs	Over 3,000 lbs					Under 3,000 lbs	Over 3,000 lbs
Tubes						Sheets (continued)					
49508	12'	100'	72	201.87	188.42	49645	16'	150'	72	201.60	188.16
49510	12'	150'	108	302.81	282.62	49646	18'	100'	54	151.20	141.12
49511	14'	100'	84	235.52	219.82	49648	18'	150'	81	226.80	211.68
49513	14'	150'	126	353.28	329.73	49649	20'	100'	60	168.00	156.80
49514	16'	100'	96	269.17	251.22	49651	20'	150'	90	252.00	235.20
49516	16'	150'	144	403.75	376.83	49652	21'	100'	63	176.40	164.64
49517	18'	100'	108	302.81	282.62	49654	21'	150'	94	264.60	246.96
49519	18'	150'	162	454.22	423.94	49655	24'	100'	72	201.60	188.16
49520	20'	100'	120	336.46	314.03	49657	24'	150'	108	302.40	282.24
49522	20'	150'	180	504.69	471.04	49658	28'	100'	84	235.20	219.52
49523	21'	100'	126	353.28	329.73	49660	28'	150'	124	352.80	329.28
49525	21'	150'	189	529.92	494.59	49661	32'	100'	96	268.80	250.88
49526	24'	100'	144	403.75	376.83	49492	32'	150'	144	403.20	376.32
49528	24'	150'	216	605.62	565.25	49493	36'	100'	108	302.40	282.24
49529	25'	100'	150	420.57	392.53	49495	36'	150'	162	453.60	423.36
49531	25'	150'	225	630.86	588.80	49496	40'	100'	120	336.00	313.60
Sheets						49498	40'	150'	180	504.00	470.40
49634	10'	100'	30	84.00	78.40	49499	42'	100'	126	388.08	362.21
49636	10'	150'	45	126.00	117.60	49501	42'	150'	189	529.20	493.92
49637	12'	100'	36	100.80	94.08	49502	48'	100'	144	403.20	376.32
49639	12'	150'	54	151.20	141.12	49504	48'	150'	216	604.80	564.48
49640	14'	100'	42	117.60	109.76	49505	50'	100'	150	420.00	392.00
49642	14'	150'	63	176.40	164.64	49507	50'	150'	225	630.00	588.00
49643	16'	100'	48	134.40	125.44						

Custom lengths in increments of 5' available upon request. See chart below for pricing.

Special order 4 Year White 55% shade films that are ideally suited for southern growers are available upon request.

Custom Sizes – SunView 4, 6 Mil and Therm 6 Mil		Custom Sizes – Overwinter 3 Mil	
WEIGHT PER ROLL CALCULATION: Width x Length x .03 = Total Weight		WEIGHT PER ROLL CALCULATION: Width x Length x .019 = Total Weight	
PRICE PER ROLL CALCULATION: Width x Custom Length x .Sq/ Ft. Price = Grower Price			
Item #	Product	Price Per 1,000 Square Feet (\$)	
		Under 3,000 lbs	Over 3,000 lbs
49430	SunView 4, 6 Mil Clear	84.11	78.50
49431	SunView Therm 6 Mil Clear, 30% light diffusion	93.27	87.05
49436	SunView Overwinter 3 Mil White	28.68	26.77
49434	SunView 6 Mil 4 Year White	85.15	79.46





SUNVIEW THERM – 6 MIL

- Energy savings • Minimized condensation • 87% light transmission • Constant plant canopy – 55% light diffusion
- Superior puncture resistance • UV stabilized for up to 4 years

Item #	Width	Length	Lbs/Roll	Price (\$)/Roll		Item #	Width	Length	Lbs/Roll	Price (\$)/Roll	
				Under 3,000 lbs	Over 3,000 lbs					Under 3,000 lbs	Over 3,000 lbs
Tubes						Sheets (continued)					
49577	12'	100'	72	223.85	208.93	49543	16'	150'	72	223.85	208.93
49579	12'	150'	108	335.78	313.39	49544	18'	100'	54	167.89	156.70
49580	14'	100'	84	261.16	243.75	49546	18'	150'	81	251.83	235.04
49582	14'	150'	126	391.74	365.62	49547	20'	100'	60	186.54	174.11
49583	16'	100'	96	298.47	278.57	49549	20'	150'	90	279.81	261.16
49585	16'	150'	144	447.70	417.86	49550	21'	100'	63	195.87	182.81
49586	18'	100'	108	335.78	313.39	49552	21'	150'	94	293.81	274.22
49588	18'	150'	162	503.67	470.09	49553	24'	100'	72	223.85	208.93
49589	20'	100'	120	373.09	348.21	49555	24'	150'	108	335.78	313.39
49591	20'	150'	180	559.63	522.32	49556	28'	100'	84	261.16	243.75
49592	21'	100'	126	391.74	365.62	49558	28'	150'	124	391.74	365.62
49594	21'	150'	189	587.61	548.44	49559	32'	100'	96	298.47	278.57
49595	24'	100'	144	447.70	417.86	49561	32'	150'	144	447.70	417.86
49597	24'	150'	216	671.55	626.78	49562	36'	100'	108	335.78	313.39
49598	25'	100'	150	466.36	435.27	49564	36'	150'	162	503.67	470.09
49600	25'	150'	225	699.54	652.90	49565	40'	100'	120	373.09	348.21
Sheets						49567	40'	150'	180	559.63	522.32
49532	10'	100'	30	93.27	87.05	49568	42'	100'	126	391.74	365.62
49534	10'	150'	45	133.24	123.36	49570	42'	150'	189	587.61	548.44
49535	12'	100'	36	111.93	104.46	49571	48'	100'	144	447.70	417.86
49537	12'	150'	54	167.89	156.70	49573	48'	150'	216	671.55	626.78
49538	14'	100'	42	130.58	121.87	49574	50'	100'	150	466.36	435.27
49540	14'	150'	63	195.87	182.81	49576	50'	150'	225	699.54	652.90
49541	16'	100'	48	149.23	139.29						

SUNVIEW OVERWINTER – 3 MIL

- Excellent harsh winter weather protection • Tri-layered • Durable • Superior puncture resistance • 70% opacity*

Item #	Width	Length	Lbs/Roll	Price (\$)/Roll		Item #	Width	Length	Lbs/Roll	Price (\$)/Roll	
				Under 3,000 lbs	Over 3,000 lbs					Under 3,000 lbs	Over 3,000 lbs
Sheets						Sheets (continued)					
49601	10'	100'	19	28.69	26.77	49618	28'	150'	80	120.48	112.45
49603	10'	150'	29	43.03	40.16	49619	32'	100'	60	91.79	85.67
49604	12'	100'	23	34.42	32.13	49621	32'	150'	90	137.69	128.51
49606	12'	150'	35	51.63	48.19	49622	36'	100'	68	103.27	96.38
49607	16'	100'	30	45.90	42.84	49624	36'	150'	102	154.90	144.58
49609	16'	150'	45	68.85	64.24	49625	40'	100'	76	114.74	107.09
49610	20'	100'	38	57.37	53.55	49627	40'	150'	114	172.11	160.64
49612	20'	150'	57	86.06	80.32	49628	42'	100'	80	120.48	112.45
49613	24'	100'	46	68.85	64.26	49630	42'	150'	120	180.72	168.67
49615	24'	150'	69	103.27	96.38	49631	48'	100'	92	137.69	128.51
49616	28'	100'	54	80.32	74.97	49633	48'	150'	138	206.54	192.77

*30% and 55% opacity also available upon request.

Custom lengths in increments of 5' available upon request. See chart on page 98 for pricing.

Special order 4 Year White 55% shade films that are ideally suited for southern growers are available upon request.



GREENHOUSE FILMS

Freight Prepaid On Orders Over 3,000 Lbs.

IV™ Tri-Level – Clear & White

- High quality PAR (photosynthetic active radiation) film
- Contains UV block and an anti-dust additive
- Retains clarity without discoloration or cracking
- Proprietary manufacturing yields tough sheeting that resists tears, punctures and UV degradation
- Heavy-duty packaging and improved folding makes installation fast and easy

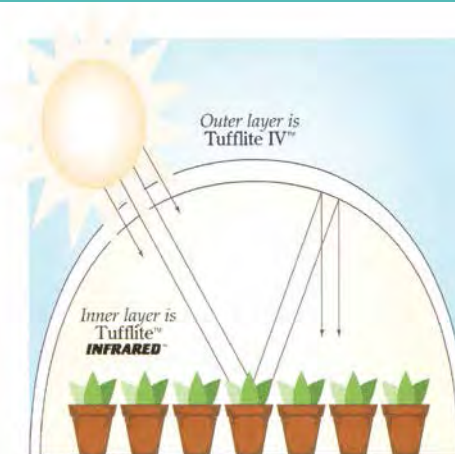

Infrared™ – Clear

- Contains the special additive “Driplless” that helps disperse plant damaging condensation build-up
- Features additional additive that delays the exit of infrared waves from the greenhouse – maintaining heat factors thus improving energy savings
- Improves light diffusion, reduces shadows

Item #	Width	Length	Lbs/Roll	Price (\$)/Roll	
				Under 3,000 lbs	Over 3,000 lbs

4 Mil Clear Tubing – 3 Year					
101151	14' 4"	220'	122	330.56	308.52
101152	15' 4"	220'	131	353.51	329.95

6 Mil Clear Tubing – 4 Year					
101184	14' 4"	220'	190	502.72	469.20
101185	15' 4"	220'	203	537.63	501.79
101153	20'	110'	133	349.11	325.83
101154	20'	150'	180	474.86	443.20
101155	24'	110'	160	418.93	391.00
101156	24'	150'	215	571.27	533.18
101158	25'	110'	165	436.39	407.29
101159	25'	150'	225	595.07	555.40
101160	28'	110'	185	488.75	456.17
101157	28'	150'	252	666.48	622.05

6 Mil Clear Sheeting – 4 Year					
101121	10'	100'	31	79.34	74.05
101122	14'	100'	42	111.08	103.67
101123	16'	100'	48	126.95	118.49
101124	20'	100'	61	158.69	148.11
101125	20'	110'	66	174.55	162.92
101126	20'	150'	90	238.03	222.16
101127	24'	100'	73	190.42	177.73
101128	24'	110'	80	209.47	195.50
101129	24'	125'	91	238.03	222.16
101130	24'	150'	108	285.63	266.59
101131	28'	100'	85	222.16	207.35
101132	28'	110'	93	244.38	228.08

Item #	Width	Length	Lbs/Roll	Price (\$)/Roll	
				Under 3,000 lbs	Over 3,000 lbs

6 Mil Clear Sheeting – 4 Year (continued)					
101133	28'	150'	126	333.24	311.02
101134	32'	100'	97	253.90	236.97
101135	32'	110'	107	279.29	260.67
101136	32'	125'	121	317.37	296.21
101137	32'	150'	144	380.85	355.46
101138	36'	110'	120	285.63	266.59
101139	36'	150'	162	428.45	399.89
101140	40'	100'	121	317.37	296.21
101141	40'	110'	133	349.11	325.83
101142	40'	125'	151	396.71	370.27
101143	40'	150'	180	474.86	443.20
101144	40'	200'	240	634.74	592.43
101145	42'	100'	128	333.24	311.02
101146	42'	150'	188	499.86	466.54
101147	48'	100'	146	380.85	355.46
101148	48'	150'	215	571.27	533.18
101149	50'	100'	152	396.71	370.27
101150	50'	150'	224	595.07	555.40
101186	56'	100'	170	444.32	414.70
101187	56'	150'	252	666.48	622.05

6 Mil White Sheeting – 4 Year					
101162	24'	100'	73	209.45	195.49
101163	24'	150'	108	314.18	293.23
101164	32'	100'	97	279.27	260.65
101165	32'	150'	144	418.90	390.98
101166	40'	100'	121	349.09	325.81
101167	40'	150'	180	523.63	488.72

Item #	Width	Length	Lbs/Roll	Price (\$)/Roll	
				Under 3,000 lbs	Over 3,000 lbs

Infrared Mil Tubing – 4 Year					
101115	20'	110'	132	401.47	374.70
101116	20'	150'	186	547.46	519.96
101117	24'	110'	160	481.76	449.64
101118	24'	150'	215	656.95	613.15

Infrared 6 Mil Sheeting – 4 Year					
----------------------------------	--	--	--	--	--

101102	20'	100'	60	182.49	170.32
101103	24'	100'	73	218.98	204.38
101104	24'	150'	108	328.47	306.58
101105	32'	100'	97	291.98	272.51
101106	32'	150'	144	437.97	408.77
101107	36'	110'	119	361.32	337.23
101108	36'	150'	162	492.71	459.86
101109	40'	100'	121	364.97	340.69
101110	40'	150'	180	547.46	510.96
101111	42'	100'	128	383.22	357.67
101112	42'	150'	189	574.83	536.51
101113	48'	100'	146	437.97	408.77
101114	48'	150'	215	656.95	613.15

*A rose by any other name
still attracts aphids.*

Custom lengths in increments of 5' available upon request. See page 101 for pricing.



GREENHOUSE FILMS

Nursery – Clear & White

- Contains all of the great features of the Tufflite IV
- 55% shade covering
- Now available in white



Black & White – 5 Mil

Tufflite Black & White is ideal for darkening and shade applications.

Item #	Width	Length	Lbs/Roll	Price (\$)/Roll	
				Under 3,000 lbs	Over 3,000 lbs
102127	20'	100'	48	100.00	93.30
102128	24'	100'	58	120.00	112.00
102129	32'	100'	77	160.00	149.30
102130	32'	150'	114	240.00	224.00
102131	40'	100'	96	200.00	186.70
102132	40'	150'	143	300.00	280.00
102133	50'	100'	119	250.00	233.30
102134	50'	150'	179	375.00	350.00
102135	50'	200'	230	500.00	466.70

Item #	Width	Length	Lbs/Roll	Price (\$)/Roll	
				Under 3,000 lbs	Over 3,000 lbs
4 Mil Clear Nursery Film					
101188	8'	220'	35	56.77	52.99
101026	10'	100'	20	32.26	30.11
101189	10'	220'	45	70.97	66.23
101027	12'	100'	24	38.71	36.13
101190	12'	220'	53	85.20	79.50
101191	14'	220'	61	99.35	92.7
101192	16'	220'	70	113.55	105.98
101030	20'	100'	40	64.51	60.21
101031	20'	150'	60	96.77	90.32
101032	24'	100'	49	77.40	72.26
101033	24'	150'	72	116.10	108.40
101034	28'	100'	57	90.32	84.30
101035	28'	150'	84	135.48	126.45
101227	28'	220'	123	198.70	185.46
101036	32'	100'	65	103.22	96.34
101037	32'	150'	96	154.80	144.50
101038	40'	100'	81	129.00	120.43
101039	40'	150'	120	193.50	180.64
101040	42'	100'	85	135.48	126.45

Item #	Width	Length	Lbs/Roll	Price (\$)/Roll	
				Under 3,000 lbs	Over 3,000 lbs
4 Mil White Nursery Film					
101193	8'	220'	35	56.77	52.99
101194	10'	100'	20	32.26	30.11
101195	10'	220'	45	70.97	66.23
101196	12'	100'	24	38.71	36.13
101228	12'	220'	53	85.16	79.48
101197	14'	220'	61	99.35	92.73
101198	16'	220'	70	113.55	105.98
101199	20'	100'	40	64.51	60.21
101200	20'	150'	60	96.77	90.32
101201	24'	100'	49	77.42	72.26
101202	24'	150'	72	116.13	108.38
101203	28'	100'	57	90.32	84.30
101229	28'	150'	84	135.48	126.45
101204	28'	220'	123	198.70	185.46
101205	32'	100'	65	103.22	96.34
101206	32'	150'	96	154.83	144.51
101207	40'	100'	81	129.03	120.43
101208	40'	150'	120	193.54	180.64
101209	42'	100'	85	135.48	126.45

6 Mil Clear Nursery Film					
101041	10'	100'	31	48.40	45.20
101042	12'	100'	36	58.10	54.20
101043	20'	100'	60	96.80	90.30
101044	20'	150'	90	145.20	135.50
101045	24'	100'	73	116.10	108.40
101046	24'	150'	108	174.20	162.60
101047	28'	100'	85	135.50	126.40
101048	28'	150'	126	203.20	189.70
101049	32'	100'	97	154.80	144.50
101050	32'	150'	144	232.30	216.80
101051	40'	100'	121	193.50	180.60
101052	40'	150'	180	290.30	271.00
101053	42'	100'	128	203.20	189.70

6 Mil White Nursery Film					
101210	10'	100'	31	48.39	45.16
101211	12'	100'	36	58.06	54.19
101212	20'	100'	60	96.77	90.32
101213	20'	150'	90	145.16	135.48
101214	24'	100'	73	116.13	108.38
101215	24'	150'	108	174.19	162.58
101216	28'	100'	85	135.48	126.45
101217	28'	150'	126	203.22	189.67
101218	32'	100'	97	154.83	144.51
101219	32'	150'	144	232.25	216.77
101220	40'	100'	121	193.54	180.64
101221	40'	150'	180	290.31	270.96
101230	42'	100'	128	203.22	189.67

CUSTOM LENGTHS ORDERING INFORMATION

Tufflite, Infrared, and Nursery Products

WEIGHT PER ROLL CALCULATION
 4 Mil Width x Custom Length x .02 = Total Weight
 6 Mil Width x Custom Length x .03 = Total Weight

PRICE PER ROLL CALCULATION
 Width x Custom Length x 1000 Sq. Ft. Price = Grower Price

Calculation on tube must be x 2.

Item #	Description	Price/1,000 sq. ft.	
		≤2,999 lbs	≥3,000 lbs
101231	Tufflite III 4 mil	49.15	45.86
101120	Tufflite IV 6 mil	86.38	80.62
101161	Tufflite IV White 6 mil	90.52	84.49
101119	Infrared 6 mil	100.47	93.77
101232	Nursery Clear 4 mil	37.50	35.00
101233	Nursery Clear 6 mil	56.24	52.49
101234	Nursery White 4 mil	37.50	35.00
101235	Nursery White 6 mil	56.24	52.49

We Care!

POLICARB® MULTIPLE WALL COEXTRUDED POLYCARBONATE SHEETS



High-Light Transmission • Virtually Unbreakable • Easily Fabricated • Anti-Drip/Anti-Fog Coating

Polycarbonate twin-wall and triple-wall sheeting is the perfect glazing for any greenhouse application. Its unique properties translate into a wide range of benefits, not the least cost savings compared to alternative greenhouse protection products such as glass.

- The surface of the material is protected from the degradation effects of UV radiation by a proprietary co-extrusion process
- Beneficial infra-red light passes through the material promoting an ideal growth environment
- Resins used have been specially developed for excellent flame retardant properties

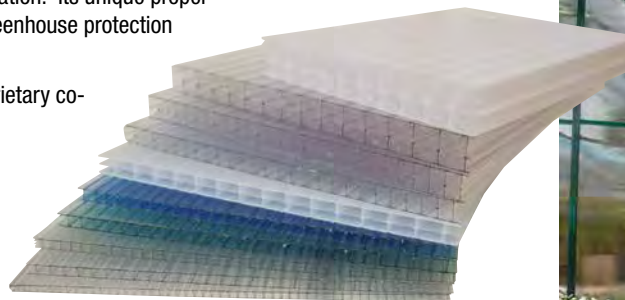

Specifications:	Thickness	Light Transmission	Solar Factor	Shading Coefficient
8 mm Twin-Wall Clear	5/16"	81%	.82	.94
8 mm Triple-Wall Clear	5/16"	76%	.78	.90

Item #	Description	Standard Widths	Price/Sq. Ft. ≤ 3,000 (\$)	Price/Sq. Ft. > 3,000 (\$)
48083	8 mm Twin-Wall, Clear	47 1/4", 48", 71 1/4", 72"	1.13	.96
48084	8 mm Triple-Wall, Clear	47 1/4", 48", 71 1/4", 72"	1.52	1.43

Crate charges are \$12.00 a linear foot based on the longest sheet with an \$80.00 minimum. FOB Wisconsin. Bronze and opal versions available upon request. Two sided UV protection is available upon request. Full 48" and 72" widths with anti-fog condensation is available upon request.

Accessories

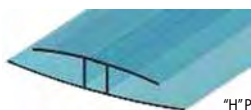

"H" Profile



"U" Profile

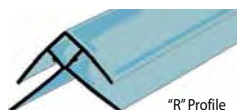

"R" Profile

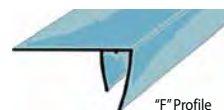

"F" Profile

Item #	Description	Length	Price/Sq. Ft. (\$)
"H" Profiles – Used to connect PolyCarb sheets together			
48085	Profiles "H" UV protected	288"	1.06
"U" Profiles – Used to finish the open ends and edges of the panels • Used in conjunction with tape to keep the panels clean			
48086	Profiles "U" UV protected	288"	.52
"R" Profiles – Used to create ridges, corner or angles • Can be adjusted from 0°- 90°			
48087	Profiles "R" UV protected	288"	2.06
"F" Profiles – Used in flashing for meeting walls and roofs			
48088	Profiles "F" UV protected	288"	1.96

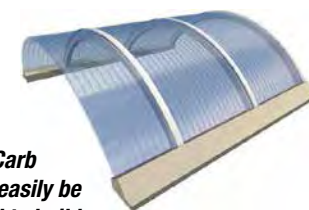

PoliCarb can easily be used to build integral arc structures since it's fluted construction increases the rigidity of the sheet allowing bending along the ribs.

POLISOFT® 8 MM TWIN-WALL DIFFUSED POLYCARBONATE SHEETS

- 100% light diffusion
- Promotes more growth cycles
- Prevents direct sunlight from burning plants
- Reduces solar heat gain



Specifications:	Thickness	Light Transmission	Solar Factor	Shading Coefficient
Twin-Wall Diffused	5/16"	80%	.78	.90

Item #	Description	Standard Widths	Price/Sq. Ft. ≤ 3,000 (\$)	Price/Sq. Ft. > 3,000 (\$)
49750	8 mm Twin-Wall Diffused	47 1/4", 48", 71 1/4", 72"	1.36	1.28

Crate charges are \$12.00 a linear foot based on the longest sheet with an \$80.00 minimum.

Additional Gallina USA items featured on the next page.

GALLINA USA 

ALUMINUM POLI-LOK SYSTEM



Use with Polycarbonate Sheets!

- High-quality materials assure long-life; premium gaskets prevent the penetration of water, dust, and dirt
- Weather resistant aluminum extrusion
- Distributes load pressure to prevent stress on sheets
- Seamless finish with concealed screw covers
- Easy assembly and installation

Call your Gloeckner representative for additional info and pricing.

*Every order comes with gasket for aluminum profile (#2760), thermal brake profile (#2761), upper aluminum profile with hidden screw (#4892), hidden screw profile 2/25 (#4892), Poli-Log plug (#4898), and Gallina Polycarbonate.



GALLINA USA 

POLICARB® POLIJUANA® LIGHT DEPRIVATION SHEETS

100% Light Deprivation!

Ideal for Marijuana Greenhouses, PolyCarb Light Deprivation Sheets feature a UV coating that prevents yellowing as well as heat and light deprivation. What's more, superior insulating qualities accommodate longer growing seasons and strong, durable construction protects against pests, vandals, and harsh weather.

- Lightweight material is easy to install; unbreakable
- Solar metallic grey exterior reduces solar heat gain
- Anti-drip coat; opaque appearance provides security and privacy
- 10-year warranty

Specifications:	Weight	R-Value	U-Value	VLT
8 mm Twin-Wall	0.307 lbs/ft	1.724	0.580	0%

Item #	Description	Standard Widths	Lengths	Price/Sq. Ft. (\$)
51707	8 mm Twin Wall	48"-72"	288"	Call for Price

Custom sizes available upon request.

AGRATECH 
GREENHOUSE MANUFACTURERS

GLAZING BAR & CAP

- Glazing Bar is used to splice 6' (71 ¼"W) panels, the bar is fastened to the frame at each cross member
- Glazing Cap fastens to the Glazing Bar to hold the panels in place
- Available in 8', 10', 12', 20' and 24' lengths

Item #	Size	Price (\$)	Item #	Size	Price (\$)
48328	8'	17.61	48331	20'	45.29
48329	10'	21.73	48332	24'	54.11
48330	12'	25.86			

AGRATECH 
GREENHOUSE MANUFACTURERS

TERMINAL STRIP

- Seals the lower end of the panels and keeps contaminants from being drawn up into the panel cells
- Condensation is kept away from the inside of the panels; weep holes allow condensation to drain to the outside
- Available in 12' lengths

Item #	Description	Price (\$)
43307	Terminal Strip, punched	17.86

Accessories		
43359	Porous Tape (1" x 165' roll)	30.75
43377	Sealing Tape (2" x 150' roll)	19.25
43409	Silicone Sealant Tube	15.00
43405	#12 x ¾" S.D. Tek Screw	.05
43415	#12 x 1" Wood Tek Screw	.06
43404	#10 x ½" S.T. Tek Screw	.03
43407	#12 x 1" S.D. Tek Screw w/neoprene washer	.28
43406	#12 x 1 ½" S.D. Tek Screw w/neoprene washer	.34
43402	#9 x 2" Sur-Grip Tek Screw w/1 ½" neoprene washer	.24

INNOTEC  **POLY-PATCH TAPE™**

Poly-Patch is a rugged patching tape that makes mending fast and easy and enhances the life of your greenhouse covering.

- Highly UV stabilized 6 mil polyethylene backing, mated to a UV stabilized adhesive creates an exceptionally strong bond
- Poly-Patch works to prevent spills in areas of excessive stress such as entrances and corners and in front of inflation blowers

Item #	Description	Price (\$)
41440	4" x 48'	17.25
41441	6" x 48'	25.50
41439	10" x 48'	42.50

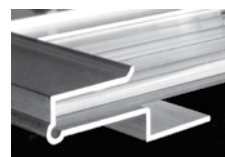
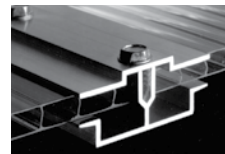

AGRATECH 
GREENHOUSE MANUFACTURERS

AGRA LOCK POLY FASTENER

Agra Lock all aluminum self locking parts feature a 12' base section and easy-to-install 1' or 2' top sections.

- No clips to cut poly and no inserts to lose their shape
- Self shading – protects Poly from UV rays; prevents harmful heat build-up at critical holding points
- Quick and easy installation/removal – no special tools required
- Reusable season after season

Item #	Punch	Price/12' Section (\$)
43214	12'-899'	22.00
	900'-3,599'	20.90
	3,600'-7,199'	19.80
	7,200'-11,999'	18.70
	12,000'+	17.60

For information on Agra Lock Extrusions, call your Gloeckner Greenhouse System Design Team at 800-345-3787.



SPRING LOCK™ FILM & FABRIC FASTENER

Growing Systems, Inc.

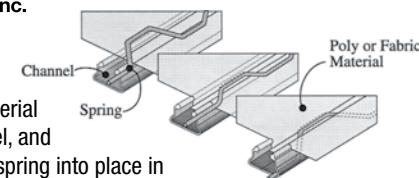

- Fast and easy system works by pulling the material across the channel, and inserting the soft spring into place in the bottom of the channel
- Does not pinch, bind or weaken the material it secures
- Can be formed to top of curved bows
- Can be secured to any structural members
- Can be used to splice poly
- Can be installed around gable-ends by cutting "V's" out of channel
- Channel holds two springs for a stronger grip
- Film can be removed and reinstalled seasonally
- Does not change holding characteristics, even with repeated use
- Can hold any flexible material or combination of materials (from 2 to 20 mil thick)

Item #	Total Feet	Weight (lb)	Case	Price (\$)
44317	120	19	¼	228.00
44319	480	91	1	882.00
	1,920	364	4	878.00
	4,800	910	10	868.00

Replacement Springs				
44316	100	N/A	1	150.00
44318	500	N/A	1	730.00

Macrolux® CORRUGATED SHEET

- **Wider Widths** – Greca Panels come in nominal 50" (1270 mm) width
- **High Impact Resistance** – Impact resistance is 20 times greater than fiberglass and 120 times stronger than glass; can withstand over 235 pounds per inch of impact within a temperature range of -40°F to 250°F
- **Lightweight** – One-eighth the weight of glass, does not need the structural support that glass requires
- **Easy to Install** – Corrugated has been specifically designed for simple and rapid installation
- **Light Transmission** – Clear corrugated sheet transmits visible light – up to 90% to your greenhouse plants
- **Reduced UV Transmission** – Opaque to ultraviolet light and wavelengths below 385 nanometers – protects tender seedlings and greenhouse crops



Crating: A \$14.00 per foot charge based on the longest sheet length (min. \$85.00) will be charged on all orders under 2,000 lbs. An additional incremental crate charge will be incurred on all shipments over 2,000 lbs.
 Cutting: All material charged for full standard width. Length charge is to the next foot up to 24'.

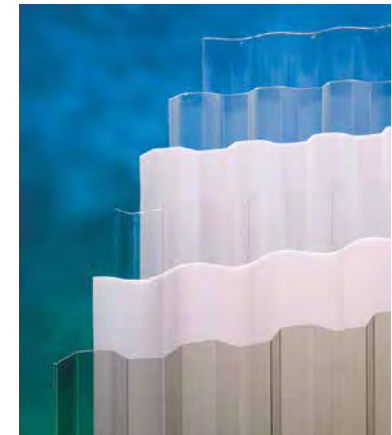

Item #	Description	Price/Sq. Ft. (\$) 1-2,000	Price/Sq. Ft. (\$) 2,001+
43871	Clear Macrolux Greca nominal 50" wide	1.00	0.94

Accessories			
48339	Horizontal Closure (Greca), 36" long		1.30 ea
48340	Vertical Closure (flat), 36" long		1.30 ea

Specifications – Macrolux Greca Clear						
Overall Width	Overall Length	Net Coverage	Pitch	Depth	Thickness	Light Transmission
Nominal 50"	Up to 48"	48"	3"	.76"	0.31"	90%

Ask about HD Soft White – a high diffusion, high light polycarbonate sheet that will help you deliver greater yields and healthier plants.

Macrolux® 8mm TWINWALL SHEET



- **Warranty** – Available with a 10 Year and a 15 Year Non-Prorated Warranty
- **Widths** – Available in 47.25", 48", 71.25", 72", and 82.67" by special order
- **Lengths** – Up to 48'
- **Light Transmission** – Up to 81%
- **No-Drip Feature** – Anti condensate that inhibits the formation of condensation into droplets
- **Accessories** – U & H Polycarbonate profiles for capping off the flutes and the transition between two sheets

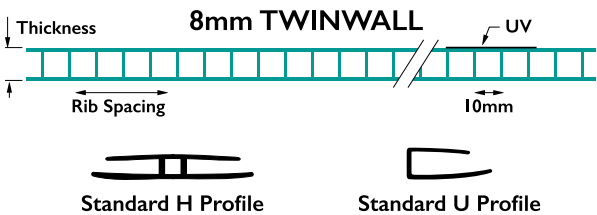

Ask about HD Soft White, Opal, Bronze and IQ Selective as colors also available.

Item #	Description	Price/Sq. Ft. (\$) 1-2,000	Price/Sq. Ft. (\$) 2,001+
48333	Clear Macrolux 8mm Twinwall	1.25	1.16

Accessories			
48336	H Profile		34.50
48337	U Profile		10.75

Specifications – Macrolux Twinwall Clear				
Overall Width	Overall Length	Thickness	Light Transmission	
47.25", 48", 71.25", 72" (82.67" by special order)	Up to 48"	0.31"	90%	

Bronze & opal versions available by special order.

Resolite®'s commitment to quality is a direct result of its ISO 9000 Quality Management System. This rigorous set of international quality standards governs every aspect of Resolite's business to assure its customers not only receive a high-quality product, but an overall experience that exceeds their expectations.





ANTICONDENS

Stop Condensation Drip In Your Greenhouse

To prevent drop formulation on the inside of any type of greenhouse so that:

- The light intensity is increased
- Disease (such as Botrytis) are prevented
- AntiCondens adheres to any type of plastic, glass, or metal
- AntiCondens is harmless to crops during normal usage
- AntiCondens is water soluble and has a neutral pH



Item #	Size	Price (\$)
49110	5 Liter	110.00
49111	25 Liter	735.75

At a recommended dilution ratio of 1:15, 1 liter of AntiCondens is sufficient to cover approximately 300 sq. meters (3,000 sq. ft.) of greenhouse area.

Meet Ricardo Campos, Manager LED Solutions

The best light recipe demands expert evaluation of your current lighting requirements and responsive consultation as to what LED lighting solutions best meet those needs.

Gloeckner's Manager of LED Solutions, Ricardo Campos, lives and breathes LED lighting and can be an invaluable resource to you as you consider the transformative benefits of Philips LED Lighting.



Contact Ricardo at 760-707-7065/rcampos@fredgloeckner.com; you will benefit greatly from his expertise and enthusiasm of LED lighting solutions.



60 CFM Single Kit



GREENHOUSE INFLATION EQUIPMENT

Double poly greenhouses with inflation pressure between layers were first developed at Rutgers University by Dr. Bill Roberts. The air space between the layers of polyethylene provides insulation without blocking sunlight. This innovation has allowed growers in cool regions to extend their growing seasons while saving up to 40% of their energy costs.

- Units are designed to pressurize these greenhouses
- All units have connectors for inserting and attaching to the poly, blower mounting brackets, and 4-foot flexible ducts

Item #	Description	Price (\$)
49082	Unit, single stack, double poly, 148 CFM	174.75
44666	Unit, single stack, double poly, 60 CFM	118.75
44663	Unit, double stack, tee, 148 CFM	196.00
49081	Unit, double stack, tee, 60 CFM	140.00
44664	Jumper Kit	36.00

Replacement items available upon request.



BATTEN TAPE

Batten tape is ideal for securing plastic film to wood frames.

- Tough, white vinyl plastic strip, 3/4" wide and 1/32" thick
- Saves hours of application and removal time
- UV and cold crack resistance



Item #	Description	Price (\$)
41040	500' roll	41.00
	500' roll, 4 rolls/case	36.70
41039	1,000' roll	74.00
	1,000' roll, 4 rolls/case	67.00



INFLATION BLOWERS

Schaefer blowers are an ideal application for circulating air between the first and second layers of poly in temporary houses. Cost effective procedure practically eliminates condensation and forms a good seal to keep the heat in the structure, where it belongs.



Item #	Mfr #	Description	Price (\$)
45177	B60	60 CFM Blower	70.00
45175	B148	148 CFM Blower	85.00



Extends Life of Film Covering!



POLY INFLATION CONTROLLER

- Regulates airflow for twin-film greenhouse blowers to maintain pressure between film layers
- Can run in manual or auto mode based on temperature and wind gusts
- Saves energy by maintaining pressure between films
- Helps prevent damage by over and under inflation
- Offers more stability in windy environments
- Offers local humidity and temperature data on the display
- Features a built in digital manometer

Item #	Description	Price (\$)
49725	Poly Inflation Controller	475.00

We Care!



WINDMASTER FANS

5 Year Warranty on Shaft and Bearing Assembly

ACME Windmaster Fans are renown for their durability and performance – it's no coincidence they've been the fan of choice in the greenhouse market for decades.

- Six-bladed propeller utilizing a cambered – twist blade designed with a unique dihedral tip that results in higher air flow capacities at less horsepower
- Non-overloading design maintains horsepower within catalog range of static pressure, resulting in lower motor load and reduced operating costs
- Improved more efficient drive assembly and super-duty neoprene belts provide longer service life
- Energy efficient totally enclosed motors with shielded ball bearings assure continuous work load
- Built-in thermal overload provides low-line voltage protection on all single phase motors



Single Panel



Double Panel

Model DCA – Slant Wall Housing

Prop and orifice constructed from lightweight all aluminum construction, housing is durable metal.

Item #	Mfr #	Fan Size	HP	RPM	CFM	Price (\$)
48094	DCA24F	24"	1/3	735	4966	613.51
48095	DCA24G	24"	1/2	820	5484	664.77
48096	DCA24H	24"	3/4	949	6793	719.18
48097	DCA30F	30"	1/3	529	6662	691.58
48098	DCA30G	30"	1/2	607	8304	739.68
48099	DCA30H	30"	3/4	686	9092	795.67
48100	DCA36F	36"	1/3	431	8526	767.28
48101	DCA36G	36"	1/2	495	9972	815.38
48102	DCA36H	36"	3/4	575	11852	871.37
48103	DCA36J	36"	1	634	12753	824.06
48104	DCA42G	42"	1/2	385	12888	993.60
48105	DCA42H	42"	3/4	442	14819	1,048.80
48106	DCA42J	42"	1	485	16108	1,001.49
48107	DCA48G	48"	1/2	308	14828	1,085.07
48108	DCA48H	48"	3/4	354	17512	1,140.27
48109	DCA48J	48"	1	384	18777	1,092.17
48110	DCA54J	54"	1	356	23124	1,238.09
48111	DCA54K	54"	1 1/2	405	25629	1,360.29

All fans priced with 115/230/volts 1 phase motors. Other voltages available upon request.

DC Models

All components are made of durable metal with a rust protection metal wash and baked on finish.

Item #	Mfr #	Fan Size	HP	RPM	CFM	Price (\$)
48112	DC24F	24"	1/3	735	5229	585.91
48113	DC24G	24"	1/2	820	5847	634.01
48114	DC24H	24"	3/4	949	6859	692.37
48115	DC30F	30"	1/3	529	7077	649.78
48116	DC30G	30"	1/2	607	8295	701.83
48117	DC30H	30"	3/4	686	9172	755.45
48118	DC36F	36"	1/3	431	8910	720.75
48119	DC36G	36"	1/2	495	10432	769.65
48120	DC36H	36"	3/4	575	12005	814.59
48121	DC36J	36"	1	634	12956	774.38
48122	DC42G	42"	1/2	385	12107	958.90
48123	DC42H	42"	3/4	442	14070	1,007.79
48124	DC42J	42"	1	485	15621	969.15
48125	DC48G	48"	1/2	308	14831	1,128.45
48126	DC48H	48"	3/4	354	17840	1,168.66
48127	DC48J	48"	1	382	19041	1,105.58
48128	DC48K	48"	1 1/2	444	21950	1,218.34
48129	DC54J	54"	1	355	22888	1,194.69
48130	DC54K	54"	1 1/2	398	25100	1,335.84

Two (2) speed fan motors are available upon request.



FLO-MASTER ALUMINUM WALL SHUTTERS

Flo-Master Fans feature precision counterbalanced aluminum blades open easier and wider to permit higher fan capacity.



Motorized

- Corrosion resistant heavy-gauge aluminum frame
- Nylon bearings throughout are corrosion proof to help prevent sticking
- Stainless steel hinge pins will not rust
- All shutter blades are reinforced with polished galvanized steel rods and are equipped with double tie-rods

Motorized Inlet Shutters

- Cam pulley operator provides long-life to motor, corrosion resistant
- Motors draw only 17 watts
- Motors available in 24v, 115v, 230v and 460v

Shutters				
Item #	Mfr #	Overall Dimensions	Sq. Ft. Opening	Price (\$)
43152	WAAC1818	18" x 18"	1.56	79.65
43153	WAAC2626	23" x 23"	3.67	110.40
43154	WAAC3333	30" x 30"	6.25	138.00
43155	WAAC4040	37" x 37"	9.50	140.37
43156*	WAAC6318	63" x 18"	6.25	175.06
43157*	WAAC6340	63" x 40"	15.42	238.15
43158*	WAAC6362	63" x 62"	24.58	274.42

Components		
Item #	Description	Price (\$)
43190	MKCAM 115-3 motor and linkage for single panel	123.81
43185	MKCAM 115V motor only for single panel	85.17
48092*	MKCAM-C-HD 115 motor and linkage for double panel	124.59
48093*	MKCAM HD 115V motor only for double panel	93.05

*Double panel shutters and motors.

DCA & DC Fans priced assembled. Includes Fan/Frame & Orifice in Slant Housing with inlet & outlet guards.
Fan Shutter not included and is sold separately.

Automatic Aluminum Fan Shutters for DCA & DC Fans

Item #	Mfr #	Fan Size	Price (\$)	Item #	Mfr #	Fan Size	Price (\$)
43127	WAA27	24"	110.40	43130	WAA45	42"	173.49
43128	WAA33	30"	108.03	43131	WAA54	48"	209.76
43129	WAA39	36"	126.17	43132	WAA60	54"	238.94



GALVANIZED SLANT & BOX EXHAUST FANS

Ideal for greenhouses where the goal is to exhaust a lot of air at a low cost.

- Heavy gauge galvanized materials
- Heavy-duty, totally enclosed, maintenance free, energy efficient motors
- Cast iron pillow block bearings
- Automatic belt tensioners
- Aluminum shutters
- Fans ship fully assembled
- 2-year limited warranty.



SCHAEFER ALUMINUM SHUTTERS

Exhaust fans require makeup air to function. Schaefer heavy duty aluminum shutters are built tough for long life in demanding environments.

- Constructed of heavy-duty brushed aluminum
- Lightweight for efficiency and easy installation
- Can be used manually, with gravity, or mechanically.

Item #	Description	Blade Type	HP	Volts	CFM @ .05 SP	Price (\$)
48048	24" Direct-drive exhaust fan in slant wall housing	5-wing	1/2	115/230	6600	680.00
48049	24" Belt-drive exhaust fan in slant wall housing	5-wing	1/2	115/230	6100	900.00
48050	30" Direct-drive exhaust fan in slant wall housing	3-wing	1/2	115/230	7200	720.00
48051	30" Belt-drive exhaust fan in slant wall housing	3-wing	1/2	115/230	6720	1,055.00
48052	30" Belt-drive exhaust fan in slant wall housing	5-wing	1/2	115/230	7010	1,025.00
48053	36" Direct-drive exhaust fan in slant wall housing	3-wing	1/2	115/230	9600	800.00
48054	36" Belt-drive exhaust fan in slant wall housing	3-wing	1/2	115/230	9340	1,100.00
48055	36" Belt-drive exhaust fan in slant wall housing	5-wing	1/2	115/230	9520	1,115.00
48056	36" Belt-drive exhaust fan in box housing	3-wing	1/2	115/230	9340	1,080.00
48057	36" Belt-drive exhaust fan in box housing	5-wing	1/2	115/230	9520	1,065.00
48060	48" Belt-drive exhaust fan in slant wall housing	3-wing	1	115/230	9300	1,235.00
48061	48" Belt-drive exhaust fan in slant wall housing	5-wing	1	115/230	18,600	1,315.00
48062	48" Belt-drive exhaust fan in box housing	3-wing	1	115/230	19,300	1,180.00
48063	48" Belt-drive exhaust fan in box housing	5-wing	1	115/230	18,600	1,290.00
49133	48" Belt-drive exhaust fan in slant wall housing	5-wing	1 1/2	208-230	23,100	1,300.00

All models have aluminum shutter and standard hardware cloth guards. Performance at 0.05" static pressure. Performances may vary. OSHA guard options available.

SCHAEFER SHUTTER MOTORS

Increase airflow through shutters by mechanically opening the shutter. Can be used on all the 'WS' aluminum shutters. Shutter will stay open as long as power is on.

- 115/230V motor
- Enclosure is suitable for wet or damp locations
- 0.5 amps at 115 volts; 0.25 amps at 230 volts.

Item #	Description	Shutter Size w/Wind	Shutter Size Against Wind	Price (\$)
48082	SHUTTERMOTOR-SM	48" and under	48" and under	125.00
49132	SHUTTERMOTOR-LG	Over 48"	Over 48"	190.00

HWKIT-LGSHUTTER is available for retrofit applications on shutters over 48" – does not include shutter motor. Using shutter motors on larger shutters than those specified invalidates our warranty.



Item #	Size	A	B	C	D	Price (\$)
48064	12"	12"	12 1/2"	15 1/4"	15 1/2"	55.00
48065	16"	16"	16 1/2"	19 1/4"	19 1/2"	65.00
48066	18"	18"	18 1/2"	21 1/4"	21 1/2"	75.00
48067	20"	20"	20 1/2"	23 1/4"	23 1/2"	95.00
48068	24"	24"	24 1/2"	27 1/4"	27 1/2"	105.00
48069	27"	27"	27 1/2"	30 1/4"	30 1/2"	115.00
48070	30"	30"	30 1/2"	33 1/4"	33 1/2"	130.00
48071	33"	33"	33 1/2"	36 1/4"	36 1/2"	150.00
48072	36"	36"	36 1/2"	39 1/4"	39 1/2"	190.00
48073	39"	39"	39 1/2"	42 1/4"	42 1/2"	220.00
48074	42"	42"	42 1/2"	45 1/4"	45 1/2"	240.00
48075	45"	45"	45 1/2"	48 1/4"	48 1/2"	265.00
48076	48"	48"	48 1/2"	51 1/4"	51 1/2"	285.00
48077	51"	51"	51 1/2"	54 1/4"	54 1/2"	310.00
48078	54"	54"	54 1/2"	57 1/4"	57 1/2"	340.00
48079	57"	57"	57 1/2"	60 1/4"	60 1/2"	385.00
48080	60"	60"	60 1/2"	63 1/4"	63 1/2"	420.00
48081	66"	66"	66 1/2"	69 1/4"	69 1/2"	445.00

A = Frame Width; B = Frame Height; C = Flange Width; D = Flange Height.
Add 1/2" to A and B for rough-in opening.

SCHAEFER THERMOSTATS

Item #	Description	Price (\$)
47086	TF115 1-Speed 115V	65.00
47087	TH109 2-Stage 115V	123.00





**LIGHT TRAP BOX EXHAUST FAN/
LIGHT TRAP PADS**

This type fan is ideal for effectively maintaining optimum humidity and air quality levels, essential for productive growing conditions. The fan and light trap pad combination will create a 100% barrier against natural light, allowing growers to precisely control growth cycles.

- Extended housing to accommodate the use of a light trap with shutter
- Used in conjunction with Schaefer Belt-Drive Light Trap Box Exhaust Fans
- Intake shutter recommended to be larger than exhaust fan



Exhaust Fan

Item #	Mfr #	Fan Size	HP	Volts	Amps	CFM	W x H	Price (\$)
51852	365B1G-LT	36"	1	115/230	9.8/4.9	9890	43" x 43"	1,080.00
51853	365B1G-2-LT	36" (2-Speed)	1	115	12.4/5.4	10,950	43" x 43"	1,080.00
51854	425B112G-LT	42"	1 1/2	208-230	6.8-6.4	14,250	49" x 49"	1,240.00
51855	485B2G-LT	48"	2	230	9.5	20,500	55" x 55"	1,500.00
51856	545B2G-LT	54"	2	230	9.5	31,300	61" x 62"	1,590.00

Breathable Wall Light Trap Fan

Item #	Mfr #	Description	Price (\$)
51913	BW 41.5 X 41.5	For 36" Fan (41.5" x 41.5")	252.00
51914	BW 47.7 X 47.7	For 42" Fan (47.5" x 47.5")	332.00
51915	BW 53.3 X 53.3	For 48" Fan (53.5" x 53.5")	420.00
51916	BW 60.25 X 59.5	For 54" Fan (60.25" x 59.5")	525.50

Shutter for Light Trap Housing

Item #	Mfr #	Size	Housing OD	Rough-In Opening	Light Trap Opening	Price (\$)
51857	SLTH-39-US	39" x 39"	44"W x 44"H x 19"D	44 3/4"W x 44 3/4"H	44 3/4"W x 44 3/4"H	255.00
51858	SLTH-51-US	51" x 51"	56"W x 56"H x 19"D	56 3/4"W x 56 3/4"H	55 3/4"W x 55 3/4"H	315.00
51859	SLTH-57-US	57" x 57"	62"W x 62"H x 19"D	62 3/4"W x 62 3/4"H	61 3/4"W x 61 3/4"H	360.00

Breathable Wall for Shutters

Item #	Mfr #	Description	Price (\$)
51917	BW 43.5 X 43.5	For 39" Shutter (43.5" x 43.5")	277.50
51918	BW 52.5 X 52.5	For 48" Shutter (52.5" x 52.5")	404.00
51919	BW 55.5 X 55.5	For 51" Shutter (55.5" x 55.5")	452.00
51920	BW 61.5 X 61.5	For 57" Shutter (61.5" x 61.5")	554.50

**Need Personal Assistance?
Call 800-345-3787**

**1,000s of Greenhouse Grower Supplies
at www.fredgloeckner.com!**

Convenient! Comprehensive! Efficient!



With so many items to choose from, online ordering has never been so easy. We have designed our site to be simple, fast, and easy to navigate. What's more, online orders can be placed on all days, at all hours, assuring the process of executing your PO will start almost immediately.

Convenient

- Open whenever you need to buy
- Mobile friendly
- Easy search; real-time pricing

Comprehensive

- Over 5,000 items currently featured
- More products added constantly
- Cost saving sales and specials; valuable tech info

Efficient

- Complete product ordering history
- Repeat orders seamlessly executed
- Current A/P balances and past accounting ledger

**It's Safe & Easy – Register Today
at www.fredgloeckner.com!**





VALUE-MASTER HORIZONTAL AIR FLOW FAN

ACME's innovative propeller design provides stellar performance and quiet operation – an ideal option for the greenhouse grower.

- From 1/15 HP PSC to 1/2 HP 3 phase, moisture resistant motors have thermal overload protection and ball bearings
- Two piece wire easy access guard has a white PVC coating to resist corrosion
- Easy to install two piece standard rotational bracket provides a locking tilt adjustment for proper air flow; fans come assembled
- "S" bracket provides two different dimensional mountings
- All single phase motors come with factory wired using either a 6 foot 116 volt or 8 foot 230 volt cord with molded plug



Item #	Mfr #	Fan Size	HP	Volts	RPM	Price (\$)
43162	HAF12A4	12"	1/15	115/1	1566	173.49
43163	HAF20A4	20"	1/15	115/1	1626	190.83
43164	HAF20F4	20"	1/3	115/230/1	1686	259.44
43166	HAF36G8	36"	1/2	115/230/1	808	420.30

Optional standard mounting bracket available upon request.



DEEP GUARD VERSA-KOOL® CIRCULATION FANS



Reduce heat stress and increase productivity with Schaefer circulation fans. The deep guard design allows for greater air movement at very low noise levels.

- Extremely rugged guards and housings for long life
- Patented deep guard spacing and custom engineered blades result in greater air movement at lower noise levels
- Depth of front guard makes fan extremely safe, but not OSHA compliant if mounted below seven feet
- Steel guards are powder coated over zinc for corrosion resistance
- Heavy-duty, totally enclosed, maintenance free motors
- Two-year limited warranty.



Item #	Description	HP	Volts	CCFM	RPM	Price (\$)
Circulation Fans						
45181	12" Fan	1/10	115/230	1470	1725	155.00
48041	12" Fan, galvanized guards	1/10	115/230	1470	1725	155.00
45182	20" Fan	1/3	115/230	5470	1725	225.00
48043	20" Fan, galvanized guards	1/3	115/230	5470	1725	225.00
45183	24" Fan	1/2	115/230	7860	1725	260.00
Pole Mounted Fans						
48045	12" Fan, standard pole mount	1/10	115/230	1470	1725	240.00
48046	12" Fan, twin tube pole mount	1/10	115/230	1470	1725	240.00
48047	12" Fan, channel pole mount	1/10	115/230	1470	1725	240.00

Variable speeds with optional motor speed control.



STEEL FAN-JET AIR DISTRIBUTION SYSTEM

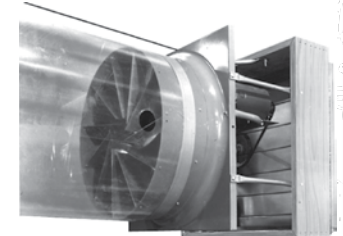

- Low-cost Fan Jet powers more air at less horsepower for best results at low operating costs
- Fan-Jet is made from quality steel and is rust protected with a metal wash process and a baked-on finish
- Quiet motors feature a totally enclosed energy efficient design with shielded ball bearings and thermal overload protection

Item #	Fan Size	HP	RPM	Price (\$)
43021	18"	1/4	1160	445.54
43022	24"	1/3	735	609.57
43026	30"	1/2	607	722.33

Please specify Direct Drive or Belt Drive Models When Ordering.



POLY CONVECTION TUBING

Available in Standard and Custom Punches



- Sold in Linear Foot
- Clear polyethylene is protected with a strong ultraviolet inhibitor
- Each tube is guaranteed to support the cubic feet/minute output of the fan for which it is designed
- 4 mil tubing is guaranteed for 1 year, 6 mil for 3 years
- Ken-Bar provides the proper hole diameter and spacing to conform to each fan manufacturers' specifications

Item #	Description	Weight	Price (\$)
49083	4 mil, 12" Dia	9 lbs/100'	.61
49084	4 mil, 18" Dia	12 lbs/100'	.75
49085	4 mil, 20" Dia	13 lbs/100'	.84
49086	4 mil, 24" Dia	15 lbs/100'	.97
49087	4 mil, 30" Dia	19 lbs/100'	1.14
49088	4 mil, 36" Dia	21 lbs/100'	1.25
49089	6 mil, 12" Dia	13 lbs/100'	.78
49090	6 mil, 18" Dia	16 lbs/100'	1.00
49091	6 mil, 24" Dia	22 lbs/100'	1.30
49092	6 mil, 30" Dia	27 lbs/100'	1.61

Discounts: 10% at 1000', 15% at 1500', 20% at 2000' single roll.



KOOL-CEL EVAPORATIVE COOLING SYSTEM FOR 4" OR 6" PADS

ACME's CSEG 6" and CAEG 4" Evaporative Cooling Systems offer ease of installation and very low maintenance. The gutter's UV protection and rugged stainless steel CSG or aluminum CAEG top provides many years of trouble-free operation.

- Easy-to-install system requires minimal long-term maintenance
- Water tight preformed gutter serves as a storage tank
- Durable stainless steel construction
- Features UV protected gutter
- Pads are continuous through split system

A complete turnkey system can be customized to your unique needs. One complete system includes the following components:

- Kool-Cel System (Frame)
- Submersible Pump
- Kool-Cel Pads
- In Line Tank
- Topaz Water Valve

Please contact your Gloeckner representative for development assistance and custom pricing.



Item #	Description	Price (\$)
48351	CAEG 4" Kool-Cel System (Frame)	Call for Price
48352	CSEG 6" Kool-Cel System (Frame)	Call for Price
48353	Topaz Water Valve 3/4" 50 GPM @ 50 PSI	115.13
48354	In Line Tank Kit	257.86

Units - Pump			
Item #	Description	Voltage	Price (\$)
48347	20S Submersible	115/1	320.95
48348	40S Submersible	115/1	263.38
48349	70S	115/1	434.50
48350	70S	230/1	383.25

Kool-Cel Pads - No Coating							
4" Thick x 12" Wide x Height				4" Thick x 16" Wide x Height			
Item #	Mfr #	Pad Height	Price (\$)	Item #	Mfr #	Pad Height	Price (\$)
43110	KU4-24	24"	11.83	43004	CU6-24	24"	16.56
43111	KU4-36	36"	18.14	43005	CU6-36	36"	25.23
43112	KU4-48	48"	23.66	43006	CU6-48	48"	33.91
43113	KU4-60	60"	29.27	43007	CU6-60	60"	41.79
43114	KU4-72	72"	36.27	43008	CU6-78	78"	50.47

Coated pads available. Call for details and pricing.
 One Tall Pad Support required for every two pads.
 Larger Kool-Cel Pads (84" and 96") are available by combining smaller pads.

Tall Pad Support		
Item #	Description	Price (\$)
43177	Tall Pad Support	8.67



WET WALL EVAPORATIVE COOLING SYSTEM

Ideal for greenhouses. The Schaefer Wet Wall Evaporative Cooling Systems, in conjunction with Schaefer exhaust fans, provide up to 30°F of cooling for large volume greenhouses, from the evaporation of water from Wet Wall pads (evaporative media).

- Long life, no-leak, snap together PVC system components (supply line, spray line and reservoir)
- Up to 5-year pad life with proper maintenance
- Standard Wet Wall lengths: 10' to 60' in 5' increments
- Standard Wet Wall heights: single stacked - 4', 5', or 6'; double stacked - 8' to 12' in 1' increments
- Easy to install, operate and maintain
- Water that does not evaporate is recycled through the pads; no wasted water
- Custom lengths and heights available
- Choice of 4" or 6" pad thickness
- Choice of center-feed and end-feed water supply
- Choice of 1/3 HP or 3/4 HP Gould™ pumps; 110V or 220V
- Single or multi-stage automatic controls available



Call your Gloeckner representative for assistance in designing an Evaporation Cooling System from Schaefer that works for you.



WET WALL PADS/EVAPORATIVE MEDIA

For use in Schaefer Wet Wall Cooling Systems and wet wall systems from other manufacturers.

- Fluted cellulose pads designed for maximum airflow, maximum evaporation, structural strength and long life
- Choice of thicknesses: 4" and 6". Select thin pads for maximum airflow; select thick pads for maximum evaporation and cooling
- Choice of widths: 12" or 24"
- Choice of lengths: 4', 5' and 6"
- Choice of uncoated, 1-side coated and 2-side coated; Edge coating increases strength, permits contact and non-contact pad cleaning, slows algae growth and improves aesthetics



Call your Gloeckner representative for custom, current pricing.



Bartlett instrument Company has been a manufacturer of instrumentation equipment and controls for over 60 years, creating a tradition of providing quality products and excellent support. Bartlett Automated Temperature Controls are widely used in greenhouse operations and are renowned for their consistency, convenience, energy savings and growing advantages.

Bartlett controllers can be divided into two types: controls for houses with louvers and fans (**GHK Models**) and controls for houses with natural ventilation (**RWL Models**).

- DIF, DAY and NITE temperature settings
- Timer/mister output – can be used for lights, mister or fogger
- Dehumidify or humidify option
- Minimum and maximum temperature readings
- Average temperature readings for 7 days
- 1 or 2 zone operation; 2 temperature sensors

GHK Models – For Traditional Greenhouses

Staged heating and cooling with 2 heats and 4 cools for single zone operation • 1 heat and 2 cools per zone to run independent houses in 2 zone operation • Large dead band between heats and cools (over 60°)



Item #	Description	Price (\$)
48355	GHK12X2, base unit	495.00
48356	GHK12X2C, base unit with curtain/vent control	555.00
48357	GHK12x2H, base unit with set point heat and additional sensor	550.00
48358	GHK12X2CH, base unit with curtain/vent control and set point heat and additional sensor	610.00

RWL Models – For Natural Ventilation Greenhouses

2 heat and 2 proportional outputs for roof vents • 1 heat and 1 proportional per zone to run independent houses in 2 zone operation • 5 proportional steps or infinite stepping with “Vent Saver” algorithm • Weather station input for wind or rain alarm



Item #	Description	Price (\$)
48359	RWL11X2, base unit	495.00
49112	RWL11X2-1HAF, base unit w/1 HAF fan control	525.00
49113	RWL11X2-2HAF, base unit w/2 HAF fan controls	555.00

Easy-Wire Combination Controller with Pre-Wired Relay Box

Ideal and affordable combination packages
 • Features 30 Amp relays and an easy connection strip

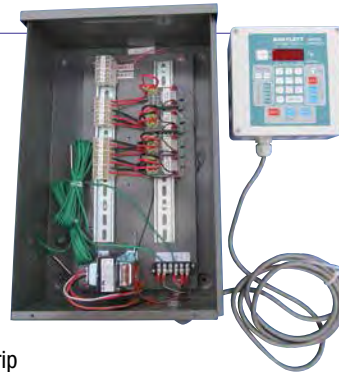

Item #	Description	Price (\$)
48360	Easy-Wire 1 pre-wired to the GHK12X2 unit (2 single speed fans, and pad pumps)	825.00
48361	Easy-Wire 2 pre-wired to the GHK12X2 unit (1 dual speed fan, and pad pumps)	825.00
48362	Easy-Wire RWL pre-wired to the RWL11X2 unit	825.00
49118	Easy-Wire RWL-1HAF pre-wired to the RWL11X2 unit (1 HAF fan control)	905.00
49119	Easy-Wire RWL-2HAF pre-wired to the RWL11X2 unit (2 HAF fan control)	985.00

Custom relay also available – call for quote.

Wind/Rain Alarm

Monitors wind and rain to protect roof vents and plants • Features 3 levels of rain sensor sensitivity • Programmable wind activate set point • Comes with an optical rain sensor



Item #	Description	Price (\$)
49114	Wind/Rain Alarm	715.00

RELAY BOXES

Bartlett Instrument Company manufactures the following high-quality relay boxes that are ideally suited for greenhouse use.



Vent Boss

24VDC power supply • Controls 2, 5A motors for roll up/down walls • Manual and automatic controls • Resettable circuit breakers

Item #	Description	Price (\$)
49115	Vent Boss	375.00

Big Boss

24VDC power supply • Controls 2, 10A motors for roll up/down walls • Manual and automatic controls • Resettable circuit breakers

Item #	Description	Price (\$)
49116	Big Boss	465.00

ARBAM

Relay box for interfacing between the RWL11X2 and 120VAC motors • Controls for 2 different 120VAC motors • Manual and automatic controls • Limit switch connections • Inflation motor control



Item #	Description	Price (\$)
49964	Relay/Switch Box for 2 vent motors (120VAC); (Limit switch connections)	300.00
49965	Relay/Switch Box for 2 vent motors (120VAC); (Limit switch connections and inflation motor control)	365.00

Accessories

Connects multiple greenhouses to a personal computer • Easy to use interface for programming and monitoring • Displays current conditions of greenhouse • Data may be collected for later viewing or graphing • Monitor and program up to 50 controllers from a personal computer • Email & Text alerts

Item #	Description	Price (\$)
49120	Radio Link + C.I.S. – software/hardware necessary to wirelessly connect one controller (Windows XP with Service Pack 3 or higher)	700.00
49966	Radio Link: In Controller Radio (one per controller)	175.00
48366	Humidity Sensor Assembly, includes 8' cable	125.00

Link4 CORPORATION



Model 800



Model 800 Integrated Panels



MODEL 800 CONTROLLERS

- Ideal for small or medium sized greenhouses
- 8 outputs (expandable to 32 outputs), 9 stages; Operate up to 8 different pieces of equipment, including exhaust fans, pad louvers, fan jets, pad pumps, HAF fans, heaters, and more
- Monitors energy use of each piece of equipment, allowing you to adjust and save money as needed
- USB port allows you to easily transfer your data history to your computer
- Install iGrow 800 Controllers with the Standard Contactor Panel (#970-3108-09)

Item #	Description	Price (\$)
iGrow 800 Model 990-0800-02		
Features VC for controlling vents and curtains, as well as the S module which allows you to monitor from your computer, smartphone or iPhone app.		
48462	iGrow 800 (8 outputs, 9 stages w/VC & S-Communication Module)	1,295.00
iGrow Integrated Panel Model 970-3108-09		
Controller and UL approved contactor panel in one convenient system • Pre-wired units eliminate wiring errors in the field • Reduces installation costs and time		
51950	iGrow Integrated Panel with Link4 Standard Panel 3x22 Amp Contactor Modules	2,995.00

iGROW 1800 CONTROLLER

- Ideal for medium to large greenhouses
- 12 outputs (expandable to 36 outputs) with manual overrides, five micro zones, and two alarm outputs for added security
- Control capabilities include alarm auto-dialer option/interface, bench or soil heating systems, CO₂ injectors, exhausts and HAF fans, fog systems, gas heaters, lighting, irrigation systems, pad pumps and louvers, radiant heating, retractable shading systems, vents, and more
- Includes indoor digital temperature and humidity with 100' cable; Measures -30°F–150°F and 0%–95% relative humidity
- Features 4-line backlit display for programming, SmartCool™ predictive cooling, heat boost dehumidification and NEMA 4 lockable enclosure
- Compatible with iPonic Alert Systems (sold separately)
- Install iGrow 1800 Controllers with the Standard Contactor Panel with temp sensor (Model 970-3118-12)
- Optional Advanced Digital Integrated Sensor Module (ADISM): Aspirated sensor measures light, temperature, humidity, and CO₂



Item #	Description	Price (\$)
51949	iGrow 1800 Model 990-1800-02	4,999.00

Delta T Solutions

Engineering, Integrating, Innovating Systems

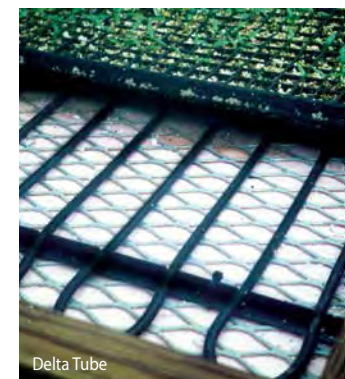

Delta Tube

Hot Water Heating Systems

Delta T hot water systems use the physics of heat to efficiently grow plants. Placing heat provides a more constant temperature, resulting in better plant quality, reduced heating bills and more sustainable energy use.

Delta Tube™ SD

This system provides the best environment for young plants and general growing. Healthy, more uniform plants and at least 20% fuel savings make this system the grower's choice. Quality synthetic tubing used will not break down under UV rays.



Delta-Fin

Delta-Fin™ TF 1 & 2

Heating the greenhouse from below the bench, this system allows for maximum temperature control and accelerated plant growth. The reduced BTUs per foot and added material result in even heat being transmitted to plants. Delta-Fin TF 1 & 2 features low water volume, high efficiency, aluminum construction, with no rusting for long life.

Call for pricing on these or any other Delta T products.

One Call – Plants/Plugs, Seeds, **Bulbs**, and Supplies

- #1 worldwide source for Flower Bulbs, Seasonal Bulb Crops, and year round production schedules
- Programmed Lilies: Hybrid and Easter Lilies
- Programmed Iris: Greenhouse and outdoors
- Dutch Flower Bulbs: Tulips, Hyacinths, Narcissus, and more
- Calla Lilies
- Specialty Bulb Crops: Ranunculus, Anemone, Paperwhites, Amaryllis, Oxalis, Sandersonia, and more



Call 800-345-3787 for a copy of the latest catalog or go to www.fredgloeckner.com to order online.

HEATMASTER CLASSIC OIL HEATERS

- All controls are wired for installation
- Electric welded steel construction
- Alumina-Silica refractors
- Adjustable air shutter for better combustion efficiency
- High fuel efficiency blower motor
- Easily serviced by local home service professional



Item #	Model	Motor	BTU	Top Opening	Weight	Price (\$)
45225	HM203	¾ HP	200,000	3 x 12"	640 lbs	5,684.00
45227	HM303	¾ HP	300,000	4 x 12"	840 lbs	6,353.00
45229	HM404	1 HP	400,000	4 x 12"	1,000 lbs	7,451.00

Standard Equipment

- 55° thermostat
- Single stage oil pump
- 12" heat distribution elbows
- Shielded cad cell flame sensor
- Summer fan switch
- Breaker disconnect box
- Flame retention burner
- Barometric damper

QUANTUM OIL HEATERS

- All controls are wired for installation
- Stainless steel baffling
- Adjustable air shutter on burner provides better operational efficiency
- Innovative design delivers high fuel efficiency
- Home quiet blower

Item #	Model	Motor	BTU	Weight	Price (\$)
45230	QT210	½ HP	210,000	620 lbs	4,672.00

Standard Equipment

- 55° thermostat
- Single stage oil pump (10' lift)
- Fan and limit control switch
- Cad cell flame sensor
- Adjustable outlet louvers
- Breaker disconnect box
- Finger protective fan guard
- Hanger adaptable hooks on case
- 24" 4-blade "Quiet Quiet" fan

Oil Heaters Accessories

Item #	Description	Price (\$)
47423	Low Temperature thermostat (30°-100°) – Adder	102.00
47424	2-Stage Fuel Pump (21' lift)	13.20



ROYAL OIL HEATERS

- All controls are wired for installation
- Stainless steel baffling
- Alumina-Silica refractors
- Adjustable air shutter on burner provides better operational efficiency
- Innovative design delivers high fuel efficiency
- Home quiet blower



Item #	Model	Motor	BTU	Weight	Price (\$)
45231	RO240	¾ HP	240,000	740 lbs	5,436.00
45232	RO320	1 HP	320,000	860 lbs	5,919.00

Standard Equipment

- 55° thermostat
- Single stage oil pump (10' lift)
- 12" heat distribution elbows
- Cad cell flame sensor
- Summer fan switch
- Breaker disconnect box
- Barometric damper
- Fully guarded blower assembly
- Energy efficient fan motor



HEAT RECLAIMER



The Heat Reclaimer delivers to your furnace 5% better fuel efficiency and up to 150° reduction in stack temperature. The bottom line cost savings over the course of a lifetime is substantial, far beyond the cost of the Heat Reclaimer.

- 120V operation, connects to existing furnace controls
- Heavy-duty construction – 12 gauge shell, 14 gauge tubes
- 12" industrial fan
- Low amp draw
- Installs in minutes, mount between furnace and draft diverter

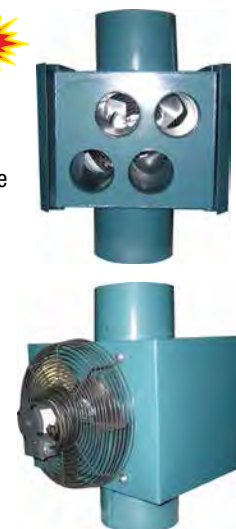

Item #	Mfr #	Description	Price (\$)
51692	002HRECLAIM	Unit	1,355.00

ROYAL GAS HEATER

- Jet/Vortex combustion design
- Easy-out burner service tray
- Jets are easily cleaned to ensure no plugging
- Horizontal air flow pattern in large buildings
- Can be used for under bench heating



Item #	Model	Motor	BTU	Gas	Weight	Price (\$)
45218	RH240	¾ HP	240,000	NAT	640 lbs	5,140.00
45217	RH240	¾ HP	240,000	LP	640 lbs	5,140.00
45220	RH360	1 HP	360,000	NAT	780 lbs	6,019.00
45219	RH360	1 HP	360,000	LP	780 lbs	6,019.00

Standard Equipment

- Draft diverter
- Stainless steel baffling
- ¾ or 1 HP energy efficiency motor

Since 1910, Siebring Manufacturing has designed and built top quality products that make producers' jobs easier.

HEATMASTER CLASSIC OIL HEATERS

- All controls are wired for installation
- Electric welded steel construction
- Alumina-Silica refractors
- Adjustable air shutter for better combustion efficiency
- High fuel efficiency blower motor
- Easily serviced by local home service professional



Item #	Model	Motor	BTU	Top Opening	Weight	Price (\$)
45225	HM203	¾ HP	200,000	3 x 12"	640 lbs	5,289.00
45227	HM303	¾ HP	300,000	4 x 12"	840 lbs	6,353.00
45229	HM404	1 HP	400,000	4 x 12"	1,000 lbs	7,451.00

Standard Equipment

- 55° thermostat
- Single stage oil pump
- 12" heat distribution elbows
- Shielded cad cell flame sensor
- Summer fan switch
- Breaker disconnect box
- Flame retention burner
- Barometric damper

QUANTUM OIL HEATERS

- All controls are wired for installation
- Stainless steel baffling
- Adjustable air shutter on burner provides better operational efficiency
- Innovative design delivers high fuel efficiency
- Home quiet blower

Item #	Model	Motor	BTU	Weight	Price (\$)
45230	QT210	½ HP	210,000	620 lbs	4,259.00

Standard Equipment

- 55° thermostat
- Single stage oil pump (10' lift)
- Fan and limit control switch
- Cad cell flame sensor
- Adjustable outlet louvers
- Breaker disconnect box
- Finger protective fan guard
- Hanger adaptable hooks on case
- 24" 4-blade "Quiet Quiet" fan

Oil Heaters Accessories

Item #	Description	Price (\$)
47423	Low Temperature thermostat (30°-100°) – Adder	75.75
47424	2-Stage Fuel Pump (21' lift)	37.20



ROYAL OIL HEATERS

- All controls are wired for installation
- Stainless steel baffling
- Alumina-Silica refractors
- Adjustable air shutter on burner provides better operational efficiency
- Innovative design delivers high fuel efficiency
- Home quiet blower



Item #	Model	Motor	BTU	Weight	Price (\$)
45231	RO240	¾ HP	240,000	740 lbs	4,884.00
45232	RO320	1 HP	320,000	860 lbs	5,465.00

Standard Equipment

- 55° thermostat
- Single stage oil pump (10' lift)
- 12" heat distribution elbows
- Cad cell flame sensor
- Summer fan switch
- Breaker disconnect box
- Barometric damper
- Fully guarded blower assembly
- Energy efficient fan motor



HEAT RECLAIMER

The Heat Reclaimer delivers to your furnace 5% better fuel efficiency and up to 150° reduction in stack temperature. The bottom line cost savings over the course of a lifetime is substantial, far beyond the cost of the Heat Reclaimer.



- 120V operation, connects to existing furnace controls
- Heavy-duty construction – 12 gauge shell, 14 gauge tubes
- 12" industrial fan
- Low amp draw
- Installs in minutes, mount between furnace and draft diverter

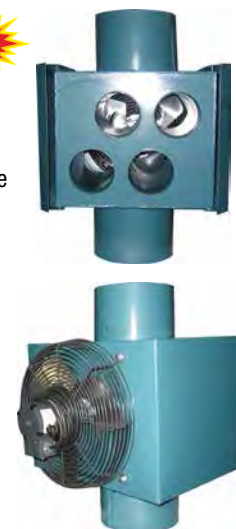

Item #	Mfr #	Description	Price (\$)
51692	002HRECLAIM	Unit	1,355.00

ROYAL GAS HEATER

- Jet/Vortex combustion design
- Easy-out burner service tray
- Jets are easily cleaned to ensure no plugging
- Horizontal air flow pattern in large buildings
- Can be used for under bench heating



Item #	Model	Motor	BTU	Gas	Weight	Price (\$)
45218	RH240	¾ HP	240,000	NAT	640 lbs	4,610.00
45217	RH240	¾ HP	240,000	LP	640 lbs	4,610.00
45220	RH360	1 HP	360,000	NAT	780 lbs	5,642.00
45219	RH360	1 HP	360,000	LP	780 lbs	5,642.00

Standard Equipment

- Draft diverter
- Stainless steel baffling
- ¾ or 1 HP energy efficiency motor

Since 1910, Siebring Manufacturing has designed and built top quality products that make producers' jobs easier.



GAS-FIRED, SEPARATED COMBUSTION, HIGH-EFFICIENCY CONDENSING HEATER

Up to 97% efficient with all models at a minimum of 93%.

- Ten model sizes available ranging from 55,000-310,000 BTU/hr
- Blowers available on models 215-310 for more robust air distribution
- Energy stat standard on all units
- All sizes are separated combustion
- Can be vented as either two-pipe or concentric vent system with 3" and 4" PVC



Propeller Unit

	Model PTC Sizes						Price
	135	155	180	215	260	310	
Btu/Hr Input*	135,000	155,000	180,000	215,000	260,000	310,000	
Btu/Hr Output*	125,550	144,150	167,400	199,950	241,800	288,300	
Condensate Production (Gal./Hr.)	1.0	1.1	1.3	1.6	1.9	2.3	
Entering Airflow (CFM) @ 70°F***	2160	2510	3020	3865	4585	5400	
Air Temp. Rise (°F)	54	53	51	48	49	49	
Max. Mounting Height (Ft.)***	14	17	15	17	20	19	
Heat Throw (Ft.) @ Max. Mtg. Ht.	51	59	53	60	70	67	

Call for current pricing information.

Also available in 55, 65, 85, and 110 BTU models. Blower units are available upon request.

GAS-FIRED UNIT HEATERS, VERTICAL POWER VENTED

Modine's time-tested PDP power vented unit heaters send all combustion products outside of the greenhouse, protecting sensitive plants from poisonous toxins. They are inexpensive to install, easy-to-use, and offer excellent in-service economy.

- 82% thermal efficiency
- A 100% shut-off, intermittent pilot-ignition system with continuous retry, *at no extra charge*



Model HD



Model PDP

Propeller Unit

	Model HD Sizes						Model PDP Sizes						Price	
	30	45	60	75	100	125	150	175	200	250	300	350		400
Btu/Hr Input*	30,000	45,000	60,000	75,000	100,000	125,000	150,000	175,000	200,000	250,000	300,000	350,000	400,000	
Btu/Hr Output*	24,600	36,900	49,200	61,500	82,000	102,500	123,000	143,500	164,000	205,000	246,000	287,000	328,000	
Entering Airflow (CFM) @70°F	505	720	990	1160	1490	1980	2180	2550	2870	3700	4460	4870	5440	
Air Temp. Rise (°F)	44	46	45	48	50	47	51	51	52	50	50	53	54	
Max. Mounting Height (Ft.)**	10	10	12	14	12	16	16	17	15	19	21	20	19	
Heat Throw (Ft.) @ Max. Mtg. Ht.**	25	27	36	38	42	56	55	59	51	67	74	70	69	

Call for current pricing information.

Blower Unit

	Model HDB Sizes				Model BDP Sizes							Price
	60	75	100	125	150	175	200	250	300	350	400	
Btu/Hr Input*	60,000	75,000	100,000	125,000	150,000	175,000	200,000	250,000	300,000	350,000	400,000	
Btu/Hr Output*	49,200	61,000	82,000	102,500	123,000	143,000	164,000	205,000	246,000	287,000	328,000	
Entering Airflow Range (CFM)	635-1111	794-1389	1140-2116	1235-2058	1587-2778	1852-3241	2116-3704	2646-4630	3175-5556	3704-6481	4233-6584	
Air Temp. Rise (°F)	40-70	40-70	35-65	45-75	40-70	40-70	40-70	40-70	40-70	40-70	40-70	
Max. Mounting Height (Ft.)**	7-13	7-16	8-19	8-17	14	15	13	16	18	19	19	
Heat Throw (Ft.) @ Max. Mtg. Ht.**	20-45	24-57	27-68	27-59	49	52	47	58	64	67	68	

Call for current pricing information.

GAS-FIRED UNIT HEATERS, HORIZONTAL POWER VENTED



The PTP line of heaters have been specifically designed and manufactured for the heating and air circulation needs of the commercial greenhouse grower. The PTP includes all of the benefits of the HD, and the following:

- Stainless steel heat exchanger comes *standard* on all units to withstand corrosive combustion air found inside a greenhouse
- 10-year heat exchanger warranty is *standard*

Propeller Unit

	Model PTP Sizes							Price
	150	175	200	250	300	350	400	
Btu/Hr Input*	150,000	175,000	200,000	250,000	300,000	350,000	400,000	Call for current pricing information.
Btu/Hr Output*	123,000	143,500	164,000	205,000	246,000	287,000	328,000	
Max. Mounting Height (Ft.)**	15	14	15	18	19	18	21	
Heat Throw (Ft.) @ Max. Mtg. Ht.**	51	50	54	62	69	65	74	



HORIZONTAL TYPE STEAM/HOT WATER HEATERS (60°F Entering Air)

Ideally suited for greenhouse applications, heaters feature horizontal air deflector blades • Vertical deflector blades are optional for complete directional control • Horizontal units are available with top/bottom (Model HSB) or side inlet/outlet (Model HC) piping connections • Available up to 340,000 BTUs per hour

Please contact your Gloeckner representative for additional product and pricing information.



VERTICAL TYPE STEAM/HOT WATER HEATERS (60°F Entering Air)

Designed for *overhead* and out-of-the-way mounting • Four deflector types are available for various air distribution patterns from high, jet-like beam to low, broad, and gentle cone • V Models have copper tubes, VN Models have cupro-nickel tubes • Available up to 952,000 BTUs per hour

Please contact your Gloeckner representative for additional product and pricing information.



GAS-FIRED, SEPARATED COMBUSTION HEATERS **Full 10-Year Warranty on Heat Exchanger**

The separated combustion models HDS/HDC and PTS/BTS draws 100% of its combustion air from outside to ensure that the unit will always have plenty of fresh, clean air to breathe. This fresh-air supply reduces common concerns about maintenance, performance, and durability in dusty, dirty or humid applications. In addition, by drawing the combustion air from the outside, the overall heating efficiency is increased. In short, the separated combustion units give you the added advantages of:

- 82% thermal efficiency for fuel savings
- A sealed compartment protects the combination gas valve, ignition control, manifold, and burner from the environment
- External gas connections
- Uses natural or propane gas (field convertible from natural to propane gas)
- Lightweight, easily installs 1" from ceiling with only two angle brackets (standard on 30-75, accessory for 100-125)
- Install quickly and easily with knockouts for quick access to gas and electricity
- Standard power exhaust simplifies side-wall or roof venting with small-diameter vent pipe
- Horizontal or vertical two-pipe or concentric venting options

Please contact your Gloeckner representative for additional product and pricing information.



Model HDS



Model PTS

Gloeckner's With You Every Step of the Way

Our interest in you and your crops by no means ends with the sale. We are more than anxious to have the materials we sell grow and prove profitable to you.



THERMA GROW™ HEATERS

Unmatched 10 Year Warranty!

Therma Grow Heaters are advanced, direct fired models that offer 20% better fuel efficiency than traditional heaters.

- 10 YEAR WARRANTY against heat chamber and case corrosion
- Completely enclosed and protected components – years of trouble-free heating
- Dependable, fuel efficient hot surface ignition
- Quick response, on-demand heat
- Units can be mounted either inside or outside; giving growers flexibility and the ability to free up grow space
- Easy integration with building controls
- Only CSA certified approved greenhouse heater on the marker
- Therma Grow Plus models provide enhanced heat management
- Doubles as CO2 generator for enriched environment



HEATER VENTILATION SYSTEMS

The Therma Grow™ line requires 2.5 CFM per 1000 BTU/h of air exchange. For a 220 model, this translates to 550 CFM of air exchange for an indoor installation, and 220 square inches of exit area for an outside mount. Similarly, a 120 model requires 300 CFM per indoor mount, and 120 square inches of exit area per outdoor mount. To make installation easy, L.B. White offers the following several preassembled kits that include application specific mounting and ventilation equipment.

Specifications:	120	120 Plus	220	220 Plus
Btu/h Rating:	120,000	65,000 & 120,000	220,000	120,000 & 220,000
Heater Configuration				
Hot Surface Ignition:	Yes	Yes	Yes	Yes
Centrifugal Blower Fan:	Yes	Yes	Yes	Yes
Air Movement (cfm):	1,100	1,100	1,750	1,750
Heat/Air Circulation Switch:	-	Yes	-	Yes
Inlet Gas Supply Pressure				
Propane min/max (in w.c.):	11/13.5	11/13.5	11/13.5	11/13.5
Natural Gas min/max (in w.c.):	7/11	7/11	7/11	7/11
Fuel Consumption (max)				
LP Gas (lbs/hr):	6.8/3.0	6.8/3.0	6.8/3.0	6.8/3.0
Natural Gas (cu. ft/hr):	117.0/63.0	117.0/63.0	215.0/117.0	215.0/117.0
Electrical Requirements*				
Requirements:	115/60/1	115/60/1	230/60/1	230/60/1
Starting/Continuous Amps:	11.8/4.5	11.8/4.5	17/7 or 6.7/2.6	17/7 or 6.7/2.6
Combustion Air Requirements				
Indoor Installation (cu. ft/min):	300	300	550	550
Outdoor Installation (in ² of exit area):	120	120	220	220
Dimensions				
Length:	30.75	30.75	35.5	35.5
Width:	21.0	21.0	25.5	25.5
Height:	28.5	28.5	30.0	30.0
Steel Case Materials:	Galvanized	White Tri-Shield**	Galvanized	White Tri-Shield**

Item #	Description	Price (\$)
Indoor Installation Kit		
48341	Therma Grow 120 Kit: includes Motorized Inlet Shutter, Shuttered Exhaust Fan, Air Inlet Hood, Eyebolts and Chains	563.50
48342	Therma Grow 220 Kit: includes Motorized Inlet Shutter, Shuttered Exhaust Fan, Air Inlet Hood, Eyebolts and Chains	567.75
Outdoor Installation Kit		
48343	Therma Grow 120: includes Exhaust Shutter, Outdoor Mount Kit	183.00
48344	Therma Grow 220: includes Exhaust Shutter, Outdoor Mount Kit	244.50
Accessories		
48345	Thermostat Kit, Nema 4X	62.75
48346	Thermostat Kit, 2 Stage Nema 4X (use with Plus models)	105.50

Item #	Description	Price (\$)	Item #	Description	Price (\$)
44684	120 LP Gas	874.50	44680	120 Plus, LP gas	1,003.50
44686	120N natural gas	874.50	44681	120N Plus, natural gas	1,003.50
44685	220 LP gas	1,094.50	44682	220 Plus, LP gas	1,181.50
44687	220N natural gas	1,094.50	44683	220N Plus, natural gas	1,181.50

*Please specify which voltage when ordering Therma Grow 220 units. **Tri-Shield coating consists of three unique protective layers including: a non-corrosive hot-dipped galvanized steel, an open-cured epoxy primer and a baked, thermosetting polyester.

1,000s of Grower Supplies and Equipment at www.fredgloeckner.com!



STEAM-FLO STEAM GENERATOR

The Sioux Steam-Flo Steam Generator is a portable unit designed for sterilizing soil in greenhouses and nurseries. It is excellent for sterilizing potting soil, bench soil, propagating sand, ground beds inside the greenhouse for vegetables, ground beds outdoors for flowers, vegetables, and nursery stock as well as pots, flats, and benches.

- Outputs 370-680 lbs. of steam per hour; Produces saturated steam in minutes
- Flexible usage – can be mounted on a trailer with 15" pneumatic wheels and pin hitch and can be towed by a tractor to an indoors or outdoors location
- After initial start-up, steam is available continuously for unlimited time periods
- Efficient unit can sterilize a 5' x 50' bench in only two hours
- Steam-Flo is constructed of heavy-duty ¼" plate steel with brass and black iron fittings
- Safety features include steam pressure relief valve, pressure control, and automatic water feeder



SF-11 with Non-Highway Trailer

Specifications	Model SF-11	Model SF-20
Fuel	Oil, LP, Natural Gas	Oil
Boiler HP	10.7 BHP	19.7 BHP
Steam Output	370 lbs/Hr	680 lbs/Hr
Firing Rate (#2 fuel Oil)	3.05 GPH	5.65 GPH
Firing Rate (LP Gas, GPH)	4.66 GPH	N/A
Firing Rate (Natural Gas, CFH)	427 CFH	N/A
Oil Fuel Tank Capacity	36 gallons	65 gallons
Boiler Volume	55 gallons	135 gallons

Item #	Description	Price (\$)
45242	SF-11 Skid Mounted Oil Fired	18,412.25
45243	SF-20 Skid Mounted Oil Fired	24,090.00
51686*	SF-11 with Non-Highway Trailer	19,762.50
51687*	SF-20 with Non-Highway Trailer	25,830.00

*Includes 15" Pneumatic Tires, Oil Fuel Tank.

Larger units and a variety of custom options are available. Call for pricing on gas fired units. Above accessories prices are for oil fired only.

PRO-GROW ELECTRIC SOIL STERILIZER

This handy item is an economical, safe and fast method to eliminate weeds and disease from soil or any other growing medium.

- Fast and accurate – the sterilizer shuts off when selected temperature is reached
- Safe – No worries regarding hazards from hot steam or dangerous chemicals
- Economical – Sterilize soil for as little as pennies on a batch
- Easy to use – Just fill with soil, set thermostat to correct temperature, wait for the indicator goes off, allow a brief cool down period, and remove the sterilized soil
- Standard Models (SS) have aluminized steel exterior and interior with stainless steel tubes
- Custom Models (SST) have aluminized steel exterior with stainless steel interior and stainless steel tubes



Item #	Mfr #	Soil Capacity	24 Hr Capacity	Dimensions	Rating	Therm ADJ	Price (\$)
Standard Models (SS)							
44967	SS60	½ cu. yd.	4 cu. yds.	61" x 32" x 16"	25 amps@240v, 50/60 HZ AC	100-200°F	3,080.00
44965	SS30	¼ cu. yd.	2 cu. yds.	33" x 32" x 16"	12 amps@240v, 50/60 HZ AC	100-200°F	2,420.00
44963	SS15	⅛ cu. yd.	1 cu. yds.	33" x 17" x 16"	12 ½ amps@120v, 50/60 HZ AC	100-200°F	1,936.00
Custom Models (SST)							
44966	SST60	½ cu. yd.	4 cu. yds.	61" x 32" x 16"	25 amps@240v, 50/60 HZ AC	100-200°F	3,740.00
44964	SST30	¼ cu. yd.	2 cu. yds.	33" x 32" x 16"	12 amps@240v, 50/60 HZ AC	100-200°F	2,956.00
44962	SST15	⅛ cu. yd.	1 cu. yds.	33" x 17" x 16"	12 ½ amps@120v, 50/60 HZ AC	100-200°F	2,296.00

STEAM STERILIZATION COVERS – 4 MIL POLYETHYLENE

The Economical Choice!

House brand poly steam sterilization cover is constructed of high-density polyethylene material with additives than can withstand higher temperatures. What's more, steam cover is lightweight, easy to maneuver and snag resistant.



Item #	Description	Price (\$)/Sq. Ft.	
		≤20'W	24'-40'W
45441	Black	.19	.21

Stock roll widths: 8', 12', 16', 20', 24', 28', 32', and 36'. Custom 40' available upon request.

CANVAS STERILIZING HOSE

The Thomas Method of steam sterilization is recognized as the simplest, and most efficient way to sterilize flower beds.



- 4" diameter Canvas Sterilizing Hose distributes the steam evenly and completely throughout the entire bed from end to end
- Its easy – merely soak the canvas tubes in detergent water, lay out the center of the bed, attach to steam outlet, tie off end of hose, cover with plastic and start the steam

Item #	Description	Price (\$)
43873	100' w/eyelets every foot	260.00
43874	100' w/o eyelets	236.00

One Call – Plants/Plugs, **Seeds**, Bulbs, and Supplies

Call 800-345-3787 for a copy of the latest catalog or go to www.fredgloeckner.com to order online.





GALVANIZED WELDED WIRE FLOWER SUPPORT

Ideal as a fabric support for long stem cut flowers, this handy item is a terrific time saver for the greenhouse grower compared to traditional methods.

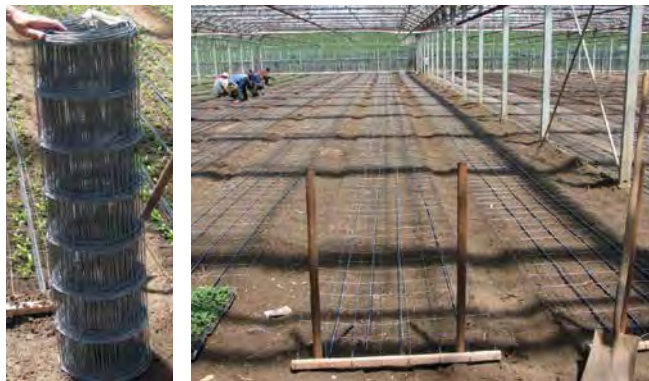

- 14 gauge wire, 6" x 8" spacing
- Easily applies as needed
- Sizes are available as follows: 36" x 100', 36" x 200', 42" x 100', 42" x 200', 48" x 100', 48" x 200'

Please call for custom pricing, bulk skid volume discounts available.

Welded Wire Flower Support is manufactured by special order only. Please allow a minimum of eight (8) weeks for delivery.



C-FLEX/CINTOFLEX C DEER FENCES

C-Flex and Cintoflex C Deer Fences come in a variety of models ranging from applications recommended in areas which experience light to moderate deer traffic. Premium versions are ideal for areas that experience moderate to heavy deer traffic.



- Black color virtually invisible against the landscape
- Can be used to enclose the perimeter of your property or smaller areas such as gardens

Item #	Description	Mesh Size	Rolls/Pallet	Price (\$)
C-Flex – For light to moderate deer traffic.				
48372	6' x 100'	1.77" x 1.97"	20	95.25
48373	6' x 330'	1.77" x 1.97"	20	240.75
48374	7.5'H x 100'L	1.77" x 1.97"	20	113.25
48375	7.5'H x 330'L	1.77" x 1.97"	20	259.75
C-Flex P (Premium) – For moderate to heavy deer traffic.				
49124	7.5'H x 330'L	1.77" x 1.97"	25	332.25
48376	7.5'H x 164'L	1.77" x 1.97"	25	211.75
C-Flex HD (Heavy Duty) – For areas with large deer traffic.				
48377	8'H x 100'L	1.77" x 1.97"	N/A	211.75
48378	8'H x 165'L	1.77" x 1.97"	N/A	313.75
Cintoflex C				
48379	10'H x 330'L	1.77" x 1.97"	20	483.25
48380	15'H x 330'L	1.77" x 1.97"	20	588.25



HORTONOVA CROP SUPPORT NET

Tenex Hortonova is a strong, versatile polypropylene mesh specially designed for more efficient and economical cold fusion of vegetables and flowers. Tenex Hortonova fully satisfies the requirements for a variety of growing techniques, both vertical and horizontal.



- Reduces installation labor costs
- Provides better exposure to light and air
- Is resistant to UV rays and chemical agents; Rot and rust proof
- Is aseptic, reducing pesticide costs
- Maximizes cultivation density
- Usage results in higher crop yields
- Size of the mesh squares is 5.9" x 6.7"

Item #	Description	Size	Price (\$)
Hortonova SM			
41214	7SM	36" x 328'	42.25
45727	7SM	36" x 3280'	228.50
41216	8SM	42" x 328'	46.50
45729	8SM	42" x 3280'	274.50
41218	9SM	48" x 328'	50.75
45731	9SM	48" x 3280'	320.00
Hortonova LM			
49121	10LM	59" x 328'	64.00
45732	10LM	59" x 3280'	411.50
51952	11LM	67" x 328'	69.25
48133	11LM	67" x 3280'	457.25
49122	13LM	78" x 328'	78.00
45733	13LM	78" x 3280'	548.75



DEER NET FOLDED

Tenex's Deer Net is the inexpensive choice for enclosing areas which need protection when a year-round fence is not necessary.



- Can also be used to cover plants as a deer deterrent
- Easy up and easy down, and is reusable from year to year
- Product folds in half for easy handling and merchandising

Item #	Description	Mesh Size	Price (\$)
48369	Deer Net, 7' x 100' rolls	.063" x 0.75"	62.75
51951	NEW! Kit*	.063" x 0.75"	129.75

*Kit includes: (1) 7' x 100 Deer Net Folded, (10) Adjustable Poles, (20) Sod Staples, (50) Small Green Ties.



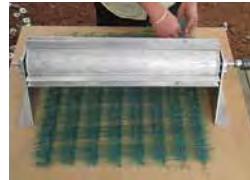
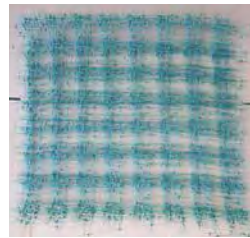

GRO-LINK GREEN MUM NETTING

Mum netting is the best and least expensive method to eliminate shrink in production and retail on large garden mums.

- Specifically designed with large 3" x 3" hole size that allows branches to grow through the netting without raising it to the top of the plant canopy
- Netting will remain in the middle of the plant canopy and blend well with green foliage
- Plants supported with Mum Netting ship and sell better, last longer in landscaping

Item #	Description	Price (\$)
49251	17" size, for use on 10" or less containers, yields 2,200 pieces	133.50
49252	23" size, for use on 11" or more containers, yields 1,700 pieces	153.50
50026	17" x 17" (pre-cut), 2,200/case	205.50
50027	23" x 23" (pre-cut), 1,700/case	176.00
49253	Net Cutting Tool	550.00



LOW TUNNELS HOOP SUPPORTED ROW COVER

Low Tunnels are ideal from the early production of a wide variety of crops.

- Slits or perforations provide daytime ventilation, eliminating the need for manual venting
- Low Tunnels are generally used in conjunction with black plastic mulch for weed control and enhanced soil warming
- Frost control or 2°F to 4°F is provided by the cover, additionally, growth is enhanced by the daily increments of solar heating
- For best results, plants should be covered for 3-4 weeks



Item #	Description	Size	Weight	Price (\$)
48406	Slitted Clear, .8 mil (2 rows of slits)	6' x 500'	15 lbs	53.50
48407	Slitted Clear, .8 mil (2 rows of slits)	6' x 1000'	27 lbs	108.00
48408	Perforated Clear, 1 mil (3/8" holes, 4.5" space)	6' x 500'	15 lbs	44.00
48409	Perforated Clear, 1 mil (3/8" holes, 4.5" space)	6' x 1000'	27 lbs	84.00
48410	Wire for hoops, #10 galvanized, 100/bundle	76"	38 lbs	104.00



PLANT SUPPORT NETS

Free Sample Upon Request!

Innovative support net is almost invisible to the eye, yet this small investment adds great value to your end product. The Nets come in several different sizes and can be adapted to any plant size (chrysanthemums, argyranthemums, ivy geraniums, poinsettias, princess lilies just to name a few).



- Nets adapt spontaneously to the shape of the plant
- Due to the small size of the mesh, the Nets do not damage the plant
- Plants will not be damaged during handling and transport with the Nets in place
- Nets give plants (especially chrysanthemums) a lovely, natural and pleasing hemispherical shape
- Once in place, the Nets are secure and will not blow away under windy weather conditions
- Nets are user-friendly and easy to use
- No additional staking or plant supports are required when using the Nets

Item #	Size	Case Pk	Price/1 cs (\$)	Price/2 cs (\$)	Item #	Size	Case Pk	Price/1 cs (\$)	Price/2 cs (\$)
47207	14" x 14"	400	40.49	N/A	47220	30" x 30"	1000	229.24	183.40
47216	14" x 14"	1000	87.99	70.39	47212	34" x 34"	400	119.90	N/A
47208	18" x 18"	400	50.24	N/A	47221	34" x 34"	1000	279.23	223.39
47217	18" x 18"	1000	115.78	92.62	47213	38" x 38"	400	144.10	N/A
47209	22" x 22"	400	63.74	N/A	47222	38" x 38"	1000	327.08	261.66
47218	22" x 22"	1000	151.25	121.00	47214	42" x 42"	400	171.88	N/A
47210	26" x 26"	400	83.38	N/A	47223	42" x 42"	1000	390.34	312.27
47219	26" x 26"	1000	189.75	151.80	47215	46" x 46"	400	202.40	N/A
47211	30" x 30"	400	103.21	N/A	47224	46" x 46"	1000	459.00	367.92

How to Choose the Right Net

Dia of your Chrysanthemum Finished Plant	Dia Of Chrysanthemum as You are About to Fit the Net	Size of Net to Use
14" (35cm)	10" (25cm)	14" x 14" (35x35cm)
18" (45cm)	12" (30cm)	18" x 18" (45x45cm)
20" (50cm)	14" (35cm)	22" x 22" (55x55cm)
22" (55cm)	16" (40cm)	22" x 22" (55x55cm)
24" (60cm)	18" (45cm)	26" x 26" (65x65cm)
26" (65cm)	20" (50cm)	30" x 30" (75x75cm)
28" (70cm)	22" (55cm)	30" x 30" (75x75cm) or 34" x 34" (85cm)
30" (75cm)	24" (60cm)	34" x 34" (85x85cm)
32" (80cm)	26" (65cm)	38" x 38" (95x95cm)
34" (85cm)	28" (70cm)	42" x 42" (105x105cm)
36" (90cm)	30" (75cm)	42" x 42" (105x105cm) or 46" x 46" (115x115cm)
38" (95cm)	32" (80cm)	46" x 46" (115x115cm)

To view an instructional video on our mum nets, either visit our Facebook page at www.facebook.com/FredGloeckner or the Fred Gloeckner channel on YouTube.com.



TYPAR CROP COVERS



Typar Crop Covers provide excellent protection from wind and insects yet let the sun and rain in. With wide covers sewn with double seams these crop covers are the strongest covers on the market. Typar Crop Covers are available in a wide variety of sizes and come folded or on rolls for roll crops.

AG06 – .6 oz/sy Pointbond

Standard widths – 6', 12', 24', 36'; standard lengths – 20', 50', 100', 150', 200', 250', 300' • General use lightweight floating row cover that transmits 70% sunlight • Durable enough for multiple uses in one season or several years with care • Increases temperature 3° to 4° at night and up to 10° during the day • Protects against insects when edges are buried • Ideal for organic gardening

Item #	Description	Price (\$)
51770	Custom (standard widths/lengths above)	.035/sq ft
51769	Bulk 6' x 2,550 ft	453.50/roll

AG09 – .9 oz/sy Pointbond

Standard widths – 6', 10', 20', 30'; standard lengths – 20', 50', 100', 150', 200', 250', 300' • Keeps heat in, bugs out and is a good windbreak for transplants • Transmits 70% sunlight and does not block rain • Provides frost protection down to 28°

Item #	Description	Price (\$)
51772	Custom (standard widths/lengths above)	.039/sq ft
51771	Bulk 6' x 2,550 ft	560.25/roll

AG125 – 1.25 oz/sy Pointbond

Standard widths – 6' wide 2, 10' wide 3, 20' wide 4, 30' wide 2; standard lengths – 20', 50', 100', 150', 200', 250', 300' • Ideal for extending growing season into early spring and late fall • Transmits 60% sunlight and does not block rain • Provides frost protection down to 24° • May need hoops for support

Item #	Description	Price (\$)
51774	Custom (standard widths/lengths above)	.0465/sq ft
51773	Bulk 6' x 2,550 ft	689.50/roll

PROGRO SHADE CLOTH

Woven

Black woven polypropylene is designed to provide years of use and is ideal for controlling sunlight and giving optimum growing opportunities.

- Minimal shrinkage of approximately 1%
- Panels are custom made to customer specifications
- Most orders shipped in less than two weeks

Item #	Shade %	Standard Widths	Price/Sq Ft (\$)
44979	30%	6', 10', 12'	.1585
44980	47%	6', 10', 12'	.164
44981	55%	6', 10', 12'	.1725
44982	63%	6', 10', 12'	.185
44983	73%	6', 10', 12'	.20
44984	80%	6', 10', 12'	.2625
44985	95%	6', 12'	.3175

Knitted

Black, monofilament knitted shade features tough Lockstitch knitted construction and is UV stabilized for long-life.

- Shade levels remain constant during product life.
- No edge taping and minimal sewing required
- Can be cut and fabricated on-site with no harmful effects

Item #	Shade %	Standard Widths	Price/Sq Ft (\$)
48381	30%	6', 10', 12'	.1675
48382	50%	6', 10', 12'	.215
48383	60%	6', 10', 12'	.22
48384	70%	6', 10', 12'	.2825



Fabrication service charge of \$10.00 per panel on all fabricated panels under 200 sq. ft. and \$20.00 for orders under \$20.00. Call for volume discount pricing on orders over 7,500 sq. ft.

Custom Fabrication and Supplies	Price (\$)
<i>Sewing Reinforcing Tape to Edges or in Body of Panel</i>	
Price per linear ft. of tape (30% thru 80%)	.19
Price per linear ft. of tape (95%)	.21
<i>Seaming Includes Taped Seams for Longer Life</i>	
Price per linear ft. of tape (30% thru 80%)	.19
Price per linear ft. of tape (95%)	.21
Slitting per linear ft.	.17
#2 grommets (5/16" hole) installed in taped edges (to your specified spacing)	.15

PROGRO GROUND COVERS

Black polypropylene fabric has been designed to prevent weed growth, yet still allow water and nutrients to pass through.

- Eliminates unsightly and hazardous water puddles
- UV stabilized for extended outdoor life
- A non-chemical solution for weed infested growing areas
- Weight is 3.0 oz/sq. yd.

Item #	Width	Length	Weight	Price (\$) 1-9	Price (\$) 10+
44973	3'	300'	25 lbs/roll	63.00	58.75
44974	4'	300'	32 lbs/roll	82.75	73.50
44975	6'	300'	50 lbs/roll	120.00	112.00
44969	10'	300'	75 lbs/roll	195.75	182.75
44970	12'	300'	88 lbs/roll	232.75	217.50
44972	15'	300'	110 lbs/roll	285.75	266.75

Accessories	
44977	Steel Ground Staples, 2" x 6", 1000/case 45.75



GROUND COVER

Dewitt offers a full line of durable Woven Ground Cover products to meet the needs of professional greenhouse growers, and nursery markets. A powerful alternative to black plastic, the fabric allows air moisture to reach the soil, saving water.



Sunbelt

3.2 oz Polypropylene, which resists tearing, puncturing, and weak penetration • Approved for most government applications • Striped every 12" to aid in plant alignment • UV-stabilized to last even in direct sunlight

Item #	Width	Length	Weight	Price (\$)
49692	3'	300'	23 lbs/roll	70.63
49693	4'	300'	27 lbs/roll	94.19
49694	6'	300'	46 lbs/roll	145.81
49695	6'	500'	75 lbs/roll	235.43
49696	10'	300'	73 lbs/roll	239.97
49697	12'	300'	92 lbs/roll	297.22
49698	15'6"	300'	112 lbs/roll	371.93



UltraWeb3000

Superior UV-treated Ground Cover for less than the cost of common 6-mil black plastic • Woven Polypropylene is ideal for safe weed control and water conservation

Item #	Width	Length	Weight	Price (\$)
49699	3'	600'	30 lbs/roll	100.38
49700	4'	600'	40 lbs/roll	133.85
49701	6'	600'	60 lbs/roll	200.75
49702	8'	600'	80 lbs/roll	267.67
49703	12' (Folds to 6')	300'	60 lbs/roll	200.75
49704	16' (Folds to 8')	300'	80 lbs/roll	267.67
49705	32' (Folds to 8')	150'	80 lbs/roll	249.25
49706	40' (Folds to 8')	120'	80 lbs/roll	249.25



White

3.2 oz white woven Polypropylene fabric • Strong, heavy fabric, which allows it to be more resistant to tearing, puncturing, and weed penetration • Can be used as an alternative to a Frost Blanket • Permeable, allowing water and nutrients to pass through • Excellent for rose growing operations

Item #	Width	Length	Weight	Price (\$)
49707	3'	300'	26 lbs/roll	81.28
49708	6'	300'	51 lbs/roll	157.10
49709	12'	300'	102 lbs/roll	314.22
49710	15'	300'	128 lbs/roll	285.49

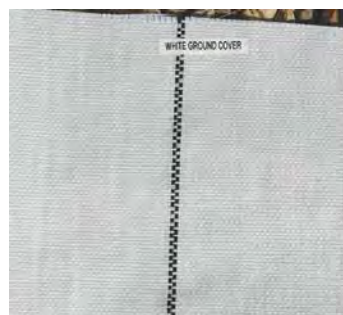

N-SULATE FROST PROTECTION BLANKET

N-Sulate is ideal for protecting flowering annuals, bedding, plants and vegetables from severe cold and freezing temperatures.

- Medium weight (1.5 oz), permeable, UV treated fabric
- Protects from freeze by raising the temperature beneath the fabric by 6°F–8°F
- Installs quickly using Dewitt Repins or Anchor pins and is reusable

Item #	Description	Price (\$)
48404	12' x 250' bulk folded to 6'	130.59
48405	12' x 500' bulk folded to 6'	253.40



Magnified



SHADE CLOTH

Armed with the largest custom sewing features in the country, Dewitt Shade Cloth products are designed to provide high quality sun and screen protection in a variety of strengths for different applications.

Knitted

100% UV stabilized Polypropylene, lightweight • Unique lock stitch construction allows customers the ability to cut the fabric with scissors without further unraveling • Zip ties can be used



Item #	Shade %	Color	Standard Widths	Price (\$)
44109	30%	Black	6', 10', 12', 14', 20', 26', 32'	.135
44110	40%	Black	6', 8', 10', 12', 20', 26', 32'	.1375
44111	50%	Black	6', 8', 10', 12', 20', 26', 32'	.1475
44113	60%	Black	6', 8', 10', 12', 20', 26', 32'	.2025
44115	70%	Black	6', 8', 10', 12', 15', 20', 26', 32'	.2425
44119	80%	Black	6', 8', 10', 12', 20', 26', 32'	.255
44122	90%	Black	6', 8', 10', 12', 20', 26', 32'	.26
44114	60%	Green	6', 10', 12', 20', 26'	.2475

Additional colors available upon request.

Woven

Made of 100% Polypropylene monofilament strands • UV stabilized to hold up under the most extreme solar conditions • Heavy and strong



Item #	Shade %	Color	Standard Widths	Price (\$)
49711	30%	Black	10', 12'	.195
49712	47%	Black	6', 10', 12', 15'	.165
49713	55%	Black	6', 10', 12', 15'	.175
49714	63%	Black	6', 10', 12', 15'	.215
49715	73%	Black	4', 6', 7.5, 10', 12', 15'	.2375
49716	80%	Black	6', 10', 12', 15'	.2675

Custom Fabrication and Supplies	Price (\$)
<i>Sewing Reinforcing Tape to Edges or in Body of Panel</i>	
Price per linear ft. of tape (30% thru 80%)	.30
<i>Seaming Includes Taped Seams for Longer Life</i>	
Price per linear ft. of tape (30% thru 80%)	.30
Slitting/cut down price per linear ft.	.21
#2 grommets (5/16" hole) installed in taped edges (to your specified spacing)	.26



Green.tek ALUMINET® SCREENS

Aluminet® Thermal Screens offer superior year round climate protection for flowers, potted plants and vegetables. Featuring *double-sided reflection*, Aluminet Screens reflect sun radiation at night, increasing plant temperature and reducing risk of freezing. Moreover, the screens prevent condensation on leaves. What's more, the use of special additives and the multifaceted reflection of the twisted Aluminet Strips contribute to efficient diffusion of incoming radiation, creating uniform light throughout the greenhouse.

Saves Energy – Aluminet Screens have been tested and proved to save over 50% of heating energy, which means direct reduction of operational costs

Increases Yields – Better temperature control, together with optimized light management, ensures maximum yield from your greenhouse • Aluminet screens raise plant temperatures at night, avoid overheating in the day and improve photosynthesis by increasing the amount of scattered light

Protects Against Frost – Aluminet Screens installed on light-frame shade houses protect crops from frost, wind, and heat stress, increasing both crop quality and productivity

Warranty – Aluminet Screens carry a long-term guarantee on product quality • All company activities are conducted under ISO 9001 and IQNet standards

Item	Shade %	Size	Price/Sq Ft (\$)
44245	30%	6 1/2', 13', 19 1/2', 26'	.305
44246	40%	7', 14', 21', 28'	.305
44247	50%	7', 14', 21', 28'	.305
44248	60%	7', 14', 21', 28'	.335
44249	70%	7', 14', 21', 28'	.38

Accessories

Item #	Description	Price (\$)
48391	Plastic Grommets, black (clip-on)	.25

Custom Fabrication

Brass Grommets installed	.23 ea
Taped edges*, black	.23/Lin. Ft.
Seams* (piece two pieces together)	.28/Lin. Ft.

*Allow additional dimensions to compensate for taped edges and seams.



Green.tek ANTI-INSECT SCREENS

Green-Tek's Anti-Insect Screens prevent insect penetration, yet provide maximum air flow, essential for optimal crop yields.

- Made of high tensile strength round polyethylene filaments
- UV stabilized and transparent
- Lightweight and easy to install
- Unique screen structure results in maximum air circulation
- Strong weave – screen keeps its strength and stability
- Easily cleaned with power sprayers by back flushing

Item #	Description	Price/Sq Ft (\$)
50 Mesh Net – Anti-Virus Screen		
For blocking whiteflies, aphids, and leafminer.		
48388	Widths – 39", 78", 118", 137", 177", 196"; 0.78 x 0.25 mm hole size	.51
75 Mesh Net – No Thrip Screen		
For blocking whiteflies, aphids, and thrips in greenhouses with forced air systems		
48389	Widths – 134"; 0.18 x 0.25mm hole size	.8025
OptiNet 50 Dual Insect Net – No Thrip Screen		
Net contains non-toxic additive that bind and repel the insects before they reach the net • Optical properties of the net are not reduced over time and are maintained throughout the nets' life cycle		
48390	OptiNet50; Widths – 39", 78", 137", 157", 196"; 0.78 x 0.25 mm hole size	.325

TYNE SHEET PEGS

- Easy-to-use, simply drive the peg into the soil every two meters
- Made from durable plastic and are reusable



Item #	Mfr #	Description	Case Pk	Price (\$)
49799	SP2EP	7.87" prong	100	66.25
51972	SP2	7.87" prong	250	143.50



CLIP-ITS

Clip-Its are a quick and ideal alternative to old brass grommets and can be used on virtually any type of screen or mesh type fabric.

- Easily installs on-site without any special equipment
- Made from environmentally friendly 100% recycled plastic



Item #	Description	Case Pack	Price (\$)
41499	Clip-It	Each	.25
48394	Clip-It bulk	300	43.54

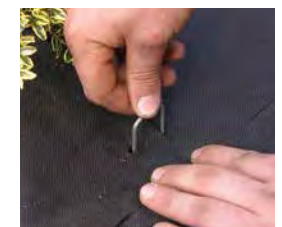

ANCHOR PINS

Primarily used for securing erosion blankets, filter fabric, landscape fabric, and grass sod to the ground.

- Wire diameter: 11 gauge = .116 inches ; 8 gauge = .157"
- All wire diameters are subject to a tolerance of +/- .002"
- Wire tensile strength: 11 gauge and 8 gauge = 90,000-110,000 psi
- Wire type is hard drawn steel wire

Item #	Description	Case Pack	Price (\$)
48395	6" x 1" x 6" 11 GA bulk	500	20.01
48396	6" x 1" x 6" 11 GA bulk	1000	37.36
48397	6" x 1" x 6" 11 GA bulk pallet	500, 108 cs/pallet	2,096.00
48398	8" x 2" x 8" 11 GA bulk	1000	75.62
48399	8" x 2" x 8" 11 GA bulk pallet	1000, 50 cs/pallet	3,667.50
48400	8" x 2" x 8" 8 GA bulk	500	68.90
48401	8" x 2" x 8" 8 GA bulk pallet	500, 50 cs/pallet	3,341.50
48402	10" x 2" x 10" 8 GA bulk	500	86.43
48403	10" x 2" x 10" 8 GA bulk pallet	500, 50 cs/pallet	4,192.00

TYNE NO RUST PEGS

Ideal for holding down ground cover. No Rust Pegs are made of durable plastic, and feature a wide head and shank for maximum hold. For best results, gently hammer into the ground every two feet.

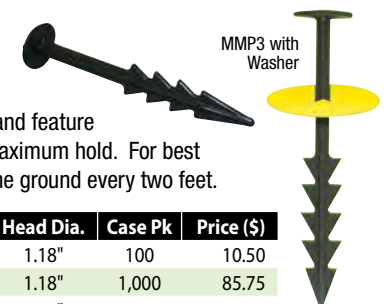

Item #	Mfr #	Length	Head Dia.	Case Pk	Price (\$)
51973	MMP2EP	5.90"	1.18"	100	10.50
49800	MMP2	5.90"	1.18"	1,000	85.75
51974	MMP3EP	7.48"	1.57"	100	12.00
49801	MMP3	7.48"	1.57"	1,000	100.00
51975	WASHER	N/A	1.97"	500	38.50



SHADING SYSTEMS

Mardenkro offers greenhouse growers a complete *shading system* to protect plants and to minimize spoilage from excessive and unpredictable heat. Additionally, an integral component of the Mardenkro Shading System is ReduClean® which easily and inexpensively washes away the shading agents and cleans the greenhouse.

ReduHeat® Liquid Greenhouse Shading

ReduHeat is a coating that contains a pigment that has the properties to transmit growth light (PAR) while increasing the reflection of heat radiation (NIR).

- More photosynthesis, therefore more growth
- Improved light penetration due to diffuse light
- Reduced use of screen shades
- Requires less ventilation, resulting in a higher CO2 content inside the greenhouse
- Improved water management, less watering required
- Applies easily to glass, acrylate, plastic and polycarbonate
- Highly wear resistant



ReduSol® Liquid Greenhouse Shading

Easily Removed With ReduClean!

ReduSol is a liquid shading product that can be used for applying a homogeneous, wear-resistant coat that protects against solar radiation. ReduSol can be applied in both thin and thick coats to glass, acrylate, polycarbonate and plastic film.

- Up to 80% shading capability
- White, even shading coat for proper reflection
- Easy to apply
- Highly resistant to frost and rain
- Increased light transmission during rain
- Diffuses light



Application Rates for ReduHeat

Ratio of ReduHeat/Water	# of Containers/ReduHeat	# of Gallons/Water	Coverage/Sq. Ft.	Shading %
1:2	1	8	2,222	40%
1:2.5	1	10	2,666	36%
1:3	1	12	3,076	32%
1:4	1	16	4,000	28%
1:5	1	20	4,444	22%

Application Rates for ReduSol

Ratio of ReduSol/Water	# of Containers/ReduSol	# of Gallons/Water	Coverage/Sq. Ft.	Shading %
1:2	1	8	2,664	80%
1:4	1	16	4,444	70%
1:6	1	24	5,712	60%
1:8	1	32	6,664	50%
1:10	1	40	8,000	40%

Item #	Size	Price (\$) 1-9	Price (\$) 10-43	Price (\$) 44+
42000	15 liter	199.75	189.75	179.75

Item #	Size	Price (\$) 1-9	Price (\$) 10-43	Price (\$) 44+
42004	15 liter	85.75	78.75	74.00

ReduClean® Cleaning Agent

Easily removes ReduHeat or ReduSol with the next rain or with an immediate rinsing.

- Applies easily to glass, acrylate, plastic and polycarbonate
- Highly effective and economical



Application Rates for ReduClean

Size	Ratio of ReduSol/Water	# of Gallons/Water	Coverage/Sq. Ft.
25 Liter	1:7	46	10,750

Item #	Size	Price (\$) 1-5	Price (\$) 6-31	Price (\$) 32+
42002	25 liter	160.00	148.50	138.50

REDUFUSE®/REDUFUSE® IR

ReduFuse Coatings diffuse light when entering the greenhouse and with the IR formulation, reduces heat radiation in addition to diffusing the light.

- High light transmission
- An evenly balanced climate due to light diffusion
- Less stress in the crop
- More photosynthesis, also in the lower leaves
- Lower leaf temperature
- Highly wear-resistant



ReduFuse®

Proven successful when applied to vegetable crops and highly light-dependent flowers and plants • Transparent during rainfall • Exclusively for glass roofs

ReduFuse® IR

High reflection of heat radiation (infrared) • Easy to remove with ReduClean • Suitable for glass, acrylate, polycarbonate, and plastic film

Item #	Size	Price (\$)
51976	15 Kg	<i>Call for prices and minimum order.</i>

Item #	Size	Price (\$)
51977	15 Kg	<i>Call for prices and minimum order.</i>

Please note: Always apply ReduSol and ReduHeat on dry and clean surfaces (for new plastic allow “non stick layer” to wear off). ReduClean should be applied on a dry ReduSol or ReduHeat layer.



F-2 ORIGINAL PRUNER



This is the original FELCO design that has remained unchanged for over sixty-five years and has set the tone for superior FELCO workmanship over the years.

- Solid forged metal alloy handles are complemented by a Swiss precision made cutting blade and anvil blade with a sap groove
- A hardened bolt and nut assure exact adjustment of both the cutting and anvil blades
- Rubber cushion and shock absorber provide smooth working and soft closing of this pruner

Item #	Description	Price (\$) 1-11	Price (\$) 12+
41459	F-2, 8 1/2"L, weighs 8.5 oz	60.50	56.50

Replacement Parts

41173	2-3 Blade	15.75	
41188	2-91 Spring Pack (2)	4.65	
41172	2-4 Anvil Blade	13.45	
41177	2-8 Center Bolt	5.60	
41178	2-9 Center Nut	4.90	
41190	2-12 Thumb Catch	2.20	
41189	2-13 Spring/Catch	.50	
41185	2-14 Screw	.75	
41176	2-15 Catch Plate	2.20	
41181	2-16 Locking Segment	1.60	
41186	2-17 Screw for Lock	.98	



F-5 PRUNER



The ideal selection for the budget minded professional.

The Economical Choice!

- Made from solid steel
- Simplified construction – low maintenance
- No cushion stop, sap groove or wire-cutting notch

Item #	Description	Price (\$) 1-11	Price (\$) 12+
41460	F-5, 9"L, weighs 11 oz	32.25	30.25



HOLSTER

FELCO's most popular holster for use on the belt or pocket.

Features a secure, high tension metal clip on back, heavy-duty grain leather, waxed threads, and extra riveting for long-use.



Item #	Description	Price (\$) 1-11	Price (\$) 12+
41458	F-910	11.25	10.50



F-6 PRUNER



Designed for those with smaller hands who may prefer a smaller, lighter pruner. Ideal for small pruning work such as grape vines, shrubs, and young trees.

- Comfortable to use, yet sturdy and powerful
- Anvil blade is screw mounted
- Shorter blades facilitate closer cutting to the stem of the plant

Item #	Description	Price (\$) 1-11	Price (\$) 12+
41461	F-6, 7 1/4"L, weighs 7.5 oz	56.00	52.25



F-8 PRUNER



The FELCO F-8 features light alloy handles that act as an extension on the forearm for the ergonomically minded grower.

- Anvil blade handle is designed to prevent the pruner from sliding through the hand
- Hardened steel blade features a wire-cutting notch
- Blades are set on dowel pins for easy maintenance and replacement

Item #	Description	Price (\$) 1-11	Price (\$) 12+
41462	F-8, 8 1/4"L, weighs 8.7 oz	58.25	54.25



LOPPERS

Two-hand pruning shears with a

straight cutting head are renown for Swiss precision quality and reliability.

- Lightweight aluminum handles; Blade and screw-mounted anvil blade made of high-quality hardened steel for clean and precise cuts
- Efficient design features easy, durable cutting adjustment, slimline cutting head, and grooved anvil blade for better grip
- Non-slip coated handles and shock absorbers protect wrists and arms
- All parts are replaceable



Item #	Description	Price (\$) 1-11	Price (\$) 12+
48386	200A-40, 15.7"L, weighs 23 oz	92.25	86.50
48387	200A-60, 23.6"L, weighs 28 oz	105.75	98.75



BP 3160



BP 3180



FORGED CLASSIC CUT® BYPASS PRUNERS

- Maximum strength forged technology
- Resharpenable bypass blade
- Slant-ground, narrow profile hook
- Sap groove

Item #	Description	Price (\$) 1-11	Price (\$) 12+
48392	BP 3130, cuts up to 1/2"	19.50	17.50
41455	BP 3160, cuts up to 3/4"	20.50	18.50
41456	BP 3180, cuts up to 1" (includes wire-cutting notch)	24.00	21.50



FORGED BYPASS PRUNER



- Lightweight forged aluminum handle
- High-carbon steel blade and hook
- Ergonomically angled head for less bending of the wrist
- Bypass allows for close, cleaner, and healthier cuts
- Practical design and component manufacturing keeps tool affordable

Item #	Description	Price (\$) 1-11	Price (\$) 12+
48393	BP 4250, cuts up to 1"	23.00	20.75



FORGED THINNING SHEAR



- Forged steel alloy construction
- Scissor cutting action
- Suitable for left and right hand use
- Resharpenable, straight, narrow blades for tight spaces
- Cushioned, non-slip grips

Item #	Description	Price (\$) 1-11	Price (\$) 12+
41457	FS 4350, 1 3/4" blade	19.50	17.50



BARNEL USA CLASSIC HEAVY-DUTY PRUNER

Ideal for Small Hands!

Features the patented two position lock that activates at the flick of the thumb. This exciting innovation enables the user to change the pruner to a smaller cutting capacity, allowing for a narrower hand spread resulting in relief of hand strain and stronger cuts.

- Drop forged aluminum handles/body
- Self oiling center bolt for ease of maintenance
- Ergonomic thermoplastic rubber (TPR) non-slip grips

Item #	Description	Price (\$) 1-11	Price (\$) 12+
41449	B200 Pruner, 5/8"	15.75	14.25



BARNEL USA STAINLESS STEEL SCISSORS

A must-have, multi-purpose snipper ideal for floral applications and more.

- AUS8 hardened stainless steel blades
- Soft gelled handles, all scissors
- Serrated blade sections (SERR)

Item #	Description	Price (\$) 1-11	Price (\$) 12+
41451	B3300 SS Scissors, 5/16"	20.75	18.75



BARNEL USA NEEDLENOSE PRUNING SHEARS

This needlenose pruner is perfectly designed for picking fruit, cutting buds, gathering vegetables, and picking flowers. Lightweight and comfortable tool can be used for extended periods.

Item #	Description	Price (\$) 1-11	Price (\$) 12+
41450	A3000 Needlenose	18.00	16.50



V3000



V3100S

BARNEL USA CLASSIC STRAIGHT NEEDLE NOSE

- High carbon tool steel twin blade (V3000 only) with straight pointed tip, for high performance
- Precision double ground blade edge, slices through the cut without crushing the capillary
- Steel body and handles, strong to support cuts of multiple applications
- Powder coated finish repels dirt, sap and fluids
- Vinyl coating of handles for easier handling

Item #	Description	Price (\$) 1-11	Price (\$) 12+
48760	V3000, Carbon 1" blade, 6 1/2"L, cutting dia. 1/4"	9.25	8.25
48761	V3100S, Stainless 1" blade, 6 1/2"L, cutting dia. 1/4"	10.00	9.00

BARNEL USA FLORAL STEM CUTTER

Add to your productivity with the handy Floral Stem Cutter.

- Mechanism slides blade horizontally when lever is moved up or down
- Optional table mounting hardware
- Arched stainless steel cutting blade, replaceable



Item #	Description	Price (\$) 1-11	Price (\$) 12+
41545	B798S Stem Cutter, blade 13 1/4"	134.75	121.25

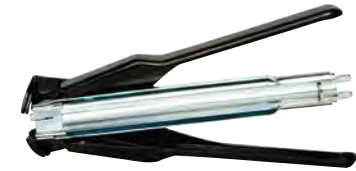

BOSTITCH P7 COLLARED RING PLIER

- Spring-loaded magazine feed
- Case hardened steel components for extreme durability
- Easy one hand operation
- Automatic feed system for ease of use and productivity

Item #	Description	Price (\$)
41413	P7	42.00
41542	616G50B blunt staples, 2500/box	17.00

BOSTITCH P6C-8P PLIER STAPLER



- Bearing system allows an easy squeeze action across operating sequence creating a quicker, tighter clinch with less strain
- P-pointed blade to penetrate cartons to clinch staple
- Coated top-load magazine permits faster, smoother staple loading

Item #	Description	Price (\$)
41412	P6C-8P (Pointed blade)	38.00
41411	P6C-8 (Blunt)	31.00
41544	STCR 5019 3/8" staples, 5000/box	18.50



Transformative!



**WE AREN'T GROWERS
– BUT WE KNOW YOUR BUSINESS.**

MasterTag, now a 4th generation business started in 1949. Our founder, Lou Schmidt, invented the plastic horticulture tag as we now know it. We share a common experience with our customers and have remained 100% devoted to horticulture throughout our 68 year history.

Providing practical and affordable solutions for growers, retailers, and consumers!

**MULTI PACKAGING SOLUTIONS
(Formerly John Henry Tags)**

To order any of the 1,000s of Multi Packaging Tags or to receive a complementary copy of their latest Catalog/Price List, please call 800-345-3787.



POLLINATOR IDENTIFYING TAG

Supporting the health of pollinators is gaining momentum with consumers, satisfy this need and do your part with these Pollinator Identifying Tags.

- The attractively designed tag identifies pollinator-friendly plants
- Easy to order in low quantities

Sizes: Round Tag, 3.5" x 3.5"; Gardener's XL Tag, 1.95" x 3.5"



BUZZ OFF! TAG

Mosquito repelling Citronella! Citronella produces a strong, lemony scent that mosquitos avoid, great for any greenhouse or garden.

Size: Gardener's XL Tag, 1.95" x 6"



POPCORN PLANT TAG

Attract an audience with a flower that looks and smells like popcorn.

Size: Gardener's XL Tag, 1.95" x 6"



XL HANG TAG

Dual purpose. Hang it on a basket or use it on a stick. Consistent look. More printable space than other hang tags.



EZ HANDLE PLUS

EZ TO RECYCLE!

Made from #5 recycle plastic. Easiest and most accepted plastic for consumer recycling.

EZ TO DISPLAY!

A longer, heavier, more robust handle ensures an upright arch for greater display presentation and easier handling.

EZ TO SEE!

Up to 40% more usable design space than other handles on the market!



Size: 1.36" x 19.75"



MASTER TAG®

The classic Master Tag labels are perfect for automatic tagging machines and for use in greenhouse production. We have the most complete stock tag listing in the industry. Includes all major breeder lines. Many exclusive! In stock and ready to go.



MID XL™ – SPECIALTY ANNUAL

For your vegetative specialty annual labeling needs, choose the convenience of the Mid-XL™ locking label. This tag draws consumers to your 4" potted annuals. Label works easily as a non-locking or locking label.

Ordering Information

If you're ordering a season's worth of tags or just need fast fill in orders, the process is easy and hassle free with Gloeckner. Here's how:

- If you have a MasterTag catalog, fill out your order and either fax to 914-698-0848 or scan and e-mail to info@fredgloeckner.com
- If you don't have a catalog, call 800-345-3787 and Gloeckner will send you a supply shortly thereafter
- If you need immediate assistance, contact your local representative (see pages 2 & 3 for territory listings of reps) or call the home office at 800-345-3787
- If you would like to order online, call 800-345-3787, and a Gloeckner representative will assist you in setting up a safe and secure account.

GARDENERS XL™

The Gardener's XL stake tag includes a large, dramatic size, edge to edge printing, and gloss coating for brighter graphics.



TYNE T-LABELS

T-Labels are designed to use where a larger label is needed. Select from the straight style or the angled style.



Item #	Mfr #	Description	Case Pk	Price (\$)
Straight T-Labels				
48432	SL135W	White, 1 1/2" x 2"W, 5 1/4"L	500	47.50
48433	SL135Y	Yellow, 1 1/2" x 2"W, 5 1/4"L	500	47.50
41417	SL250W	White, 2 1/2" x 4"W, 10"L	100	38.50
48434	SL250W	Bulk White, 2 1/2" x 4"W, 10"L	1,000	292.50
48435	SL250Y	Yellow, 2 1/2" x 4"W, 10"L	100	33.75
48436	SL250BK	Black, 2 1/2" x 4"W, 10"L	100	33.75
48437	SL250BK	Bulk Black, 2 1/2" x 4"W, 10"L	1,000	292.50
49967	SL300W	White, 2" x 4"W, 7 1/2"L	100	37.50
48438	SL340W	White, 2 1/2" x 4"W, 10 1/2"L	100	47.50
48439	SL340Y	Yellow, 2 1/2" x 4"W, 10 1/2"L	100	47.50
49968	SL445W	White, 3 1/4" x 4 3/4"W, 14 3/4"L	50	52.50
49139	SL545W	White, 3 1/2" x 5 1/2"W, 17 1/2"L	50	52.50
49140	SL735Y	Yellow, 4 1/2" x 7 1/2"W, 24"L	50	40.00
Angled T-Labels				
48440	SL190W	White, 2" x 3"W, 6"L	50	21.75
41418	SL275W	White, 3" x 5"W, 10 1/2"L	50	29.50
48441	SL275W	Bulk, White, 3" x 5"W, 10 1/2"L	500	256.25
48442	SL275Y	Yellow, 3" x 5"W, 10 1/2"L	50	29.75
41419	SL400W	White, 2 1/2" x 4"W, 15"L	50	30.75
48443	SL400W	Bulk, White, 2 1/2" x 4"W, 15"L	500	277.25
48444	SL400Y	Yellow, 2 1/2" x 4"W, 15"L	50	29.75
48445	SL400BK	Black, 2 1/2" x 4"W, 15"L	50	29.75
48446	SL400BL	Blue, 2 1/2" x 4"W, 15"L	50	29.75
48447	SL400R	Red, 2 1/2" x 4"W, 15"L	50	29.75
49142	SL440W	White, 3" x 5"W, 17 1/2"L	50	30.00
41420	SL500W	White, 4" x 6 1/2"W, 21"L	25	35.00
48448	SL500W	Bulk, White, 4" x 6 1/2"W, 21"L	250	300.00
48449	SL500Y	Yellow, 4" x 6 1/2"W, 21"L	25	35.00
48450	SL500BK	Black, 4" x 6 1/2"W, 21"L	25	35.00
49144	SL650W	White, 4" x 6 1/4"W, 25 1/2"L	25	43.75
48451	BASE	Black Label Base	25	37.75

TYNE INFO STICKS

Info Sticks hold picture labels either vertically or at 45°. Label easily clips into position and is securely held and will not spin, be blown or pulled out. What's more, the label pivots on a prong allowing the customer to read the back of the label without pulling the stick out of the soil.

Item #	Mfr #	Description	Case Pk	Price (\$)
48457	IF6	6", green	100	5.00
48458	IF11	11", green	100	6.00
48459	IF15	15", green	100	9.25
48460	IF24	24", green	100	11.75



"PYLON" PLANT MARKERS

Indoors or out, the most popular plant marker because of its easy marking and affordable price.

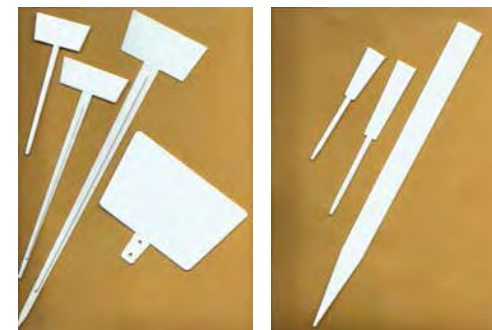

Item #	Description	Case Pk	Price (\$)
45040	M-5-B, 5"L x 2"W top	250	33.00
45041	M-8-B, 8"L x 2 1/2"W top	100	36.50
45037	M-12-B, 12"L x 3"W top	100	54.60
45038	M-13-B, 13"L x 3"H x 5"W top	100	91.00
45039	M-35-B, 3"H x 5"W	100	64.00
45007	EX-10-B, 10"L extensions	100	28.00
45043	S-4.5-B, 4 1/2"L x 3/4"W top	1000	53.50
45044	S-6-B, 6"L x 1/2"W top	500	62.25
45042	S-12-B, 12"L x 1"W top	100	44.75
45045	T-1-B Tag, 3"W x 1"H, white, wire included	500	53.75

"PYLON" POT LABELS

Sturdy Pylon Pot Labels come in a wide variety of colors to satisfy your need for form and function.

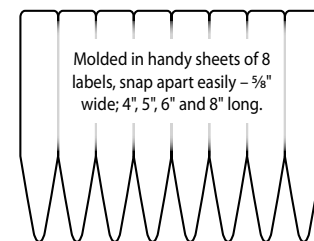

Item #	Description	Case Pk	Price (\$)
45014	L-4, 5/8"W x 4"L	1,000	39.25
45021	L-5, 5/8"W x 5"L	1,000	45.50
45028	L-6, 5/8"W x 6"L	1,000	56.25
45035	L-8, 5/8"W x 8"L	500	43.25

Only available in white.

Tyne Cares!



ECONOMY PLASTIC PLANT LABELS

Terrific plastic plant labels are die-cut from high impact recycled styrene which gives them the smoothest writing surface available.

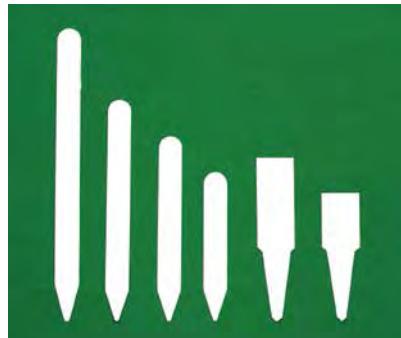

- Can be marked with soft pencils, weatherproof pencils and rubber stamps
- Markings will not come off with weather, fertilizers, soils or water
- DP's Garden Marker (see below) features UV resistant, waterproof ink and is easily removable with rubbing alcohol when used with these plant labels

Item #	Mfr #	Size	Thickness	Case Pk	Price (\$)
41423	TC458M	4"L x 5/8"W	.024"	1,000	32.50
41424	TC558M	5"L x 5/8"W	.024"	1,000	38.00
41422	TC658M	6"L x 5/8"W	.030"	1,000	43.75
41425	TC858M	8"L x 5/8"W	.030"	1,000	60.50
48430	SL351M	3 1/2"L x 1"W	.015"	1,000	20.50
48431	SL451M	4 1/2"L x 1"W	.015"	1,000	23.75

Please note that 1" wide labels are sold in rolls, 5/8" wide labels are packaged loose.



GARDEN MARKERS

Finally a line of Garden Markers that will last! Multi-purpose markers write on wood, plastic, metal, glass, porcelain, and many other materials.

- Garden Markers are fast drying, waterproof and contain ultraviolet filters for maximum fade resistance
- Environmentally friendly markers are xylene free

Item #	Description	Price (\$)	Price (\$)	Price (\$)
41407	Aluminum barrel, 0.8 mm tip	3.25	3.00	2.75



WOOD LABELS

DP Wood Labels are made from New England Birch veneer, a hardwood which offers an excellent writing surface and stellar durability.

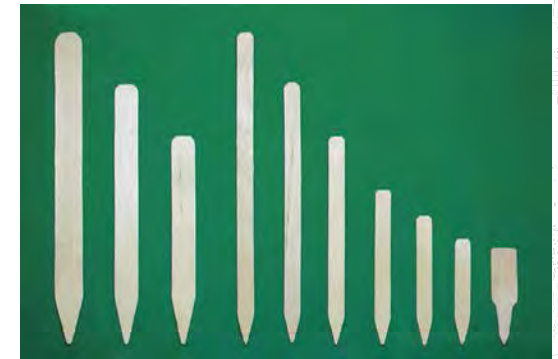

Item #	Mfr#	Size	Case Pk	Price (\$) 1CS	Price (\$) 10CS	Price (\$) 50CS	Price (\$) 100CS
Natural Color (Plain)							
48418	PL458M	4"L x 5/8"W	1000	41.50	33.00	29.85	25.75
48419	PL558M	5"L x 5/8"W	1000	36.00	28.65	26.15	22.40
44075	PL658M	6"L x 5/8"W	1000	40.50	32.50	29.50	25.40
44076	PL858C5	8"L x 5/8"W	500	41.50	33.00	29.85	25.75
44072	PL1058C5	10"L x 5/8"W	500	42.25	34.00	30.40	26.25
44074	PL1258C5	12"L x 5/8"W	500	63.50	50.75	45.75	39.65
48420	GL878C5	8"L x 7/8"W	500	44.00	35.20	32.00	27.40
48421	GL1078C5	10"L x 7/8"W	500	69.25	55.35	50.00	43.00
44073	GL12118C2	12"L x 1 1/8"W	250	45.50	36.50	33.00	30.25
White Color (Treated)							
48422	TPL458M	4"L x 5/8"W	1000	39.25	31.35	28.40	24.40
48423	TPL558M	5"L x 5/8"W	1000	42.50	33.90	30.80	26.40
44080	TPL658M	6"L x 5/8"W	1000	47.75	38.15	34.50	29.75
44081	TPL858C5	8"L x 5/8"W	500	34.25	27.35	24.80	21.25
44077	TPL1058C5	10"L x 5/8"W	500	49.75	39.90	36.15	31.00
44079	TPL1258C5	12"L x 5/8"W	500	72.75	58.25	52.95	45.50
48424	TGL878C5	8"L x 7/8"W	500	55.25	44.25	40.00	34.50
48425	TGL1078C5	10"L x 7/8"W	500	69.25	55.35	50.00	43.00
44078	TGL12118C2	12"L x 1 1/8"W	250	52.75	42.15	38.15	32.75
Color Coated Best Sellers							
48426	ORG12118C2	Orange, 12"L x 1 1/8"W	250	45.50	36.50	33.00	30.25
48427	ORG858C5	Orange, 8"L x 5/8"W	500	34.25	27.35	24.80	21.25
48428	YEL12118C2	Yellow, 12"L x 1 1/8"W	250	45.50	36.50	33.00	30.25
48429	YEL858C5	Yellow, 8"L x 5/8"W	500	34.25	27.35	24.80	21.25

All other sizes for color coated wood labels are available upon request.

It is apparent that no lifetime is long enough in which to explore the resources of a few square yards of ground.

~Alice M. Coats



AGRITAPE ROOT ZONE HEATERS

An ideal solution for propagation and bench aids, Agritape allows optimum bottom heat distribution at a cost far more attractive than wire type heaters or other space heating methods.

- High heat transfer efficiency results in minimal use of electricity – conventional greenhouse heating systems can be run in the 50°F–55°F range
- Tape is made of tough Mylar sheets in which copper strips and the heat generating film are embedded
- All units are completely sealed for long-life

Item #	Description	Price (\$)
Agritape Heat Mats Custom		
48411	11"W x 10'L	73.50
48412	11"W x 12'L with grounding screen	88.20
48413	11"W x 16'L with grounding screen	117.60
48414	11"W x 20'L with grounding screen	147.00
48415	11"W x 25'L	183.75
44656	Custom lengths under 25'	7.35/ft.

Heat Mats		
Provides supplemental bottom heat for maximum germination • Raises soil temperature up to 20°F over ambient air temperature		
49764	11"W x 4'L with grounding screen	37.50
49765	11"W x 10'L with grounding screen	65.50
49766	11"W x 25'L with grounding screen	166.75
49767	22"W x 4'L with grounding screen	69.50
49768	22"W x 8'L with grounding screen	104.00
49769	22"W x 10'L with grounding screen	124.00
49770	44"W x 6'L with grounding screen	126.75
49771	44"W x 8'L with grounding screen	149.00
49772	44"W x 10'L with grounding screen	185.50

Grounding Screen		
44657	11 mil wire mesh aluminum screen	1.20/sq.ft.

AT-1 Temperature Controller		
For up to 20 amp service • Unit has multiple receptacles and dial adjusting thermostat		
44659	Unit	145.50

AT-JR Temperature Controller		
The AT-JR is a smaller version of the AT-1 • Rated at 13 amps and will operate 80 linear feet of Agritape or 8 Agritape Heat Mats		
44651	Unit	132.00

PRO-GROW PROPAGATING MATS AND THERMOSTATS

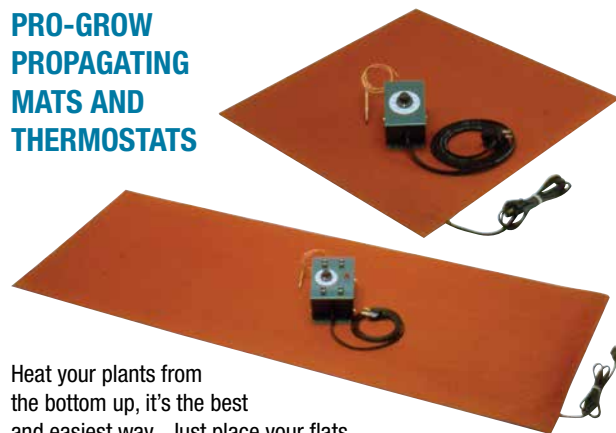

Heat your plants from the bottom up, it's the best and easiest way. Just place your flats directly on this heavy rubber mat and you'll get even bottom heat for starting seeds and cuttings. 100 watts @ 120 Volts.

Item #	Description	Price (\$)
41445	22" x 60"	176.00
48417	22" x 46"	135.00
48416	22" x 22"	85.00

Gro-Control Thermostats

Select from the following thermostats to get the best performance out of your propagating mats.

Item #	Description	Price (\$)
Model GC-1		
For use with 2 mats with plug adapter • 6ft cord with series tap plug • 120V-720W-8A RES, 1/HP IND. • Heavy-duty construction		
41254	Unit	85.00
Model GC-2		
Has 2 grounding receptacles for 2 mats, cables or other devices • 6ft cord with grounding plug • 120V-1500W-12.5A RES, 1/HP IND. • Heavy-duty construction with pilot light		
41255	Unit	139.00
Model GC-4		
Has receptacles for 4 mats • 6ft cord with grounding plug • 120V-1500W-12.5A RES, 1/HP IND. • Heavy-duty construction with pilot light		
41256	Unit	131.00

One Call – Plants/Plugs, Seeds, Bulbs, and Supplies, only at Gloeckner!

OLSON PRODUCTS LOW WATT PROPAGATION MAT

The Low Watt Propagation Mat from Olson is a great way to jump start your seedlings, and do so energy efficiently.



- Sprouts seeds in as little as 2 days; Particularly ideal for difficult seeds
- Mat uses less than 20 watts per square foot and are more energy efficient than electric cables and higher wattage mats
- Provides uniform heat, resulting from the continuous sheet heater and non-coiled wires imbedded in the mat
- One-year limited warranty

Item #	Description	Price (\$)
44825	22"x 14" 30 watts	44.00
44826	22"x 22" 60 watts	60.75
44823	22"x 44" 120 watts	74.50
44824	22"x 96" 240 watts	117.25
50454	22"x 120" 300 watts	153.50

Trays, seed and soil not included.

Thermostat for Low Watt Propagation Mats

The ideal solution for precise temperature control of germination and propagation systems. 60°F–100°F.



Item #	Description	Price (\$)
44829	FT-7, 1,000 watts max. capacity	56.25
44828	FT-15, 2,000 watts max. capacity	81.75

To plant a garden is ... to believe in summer, to have faith in tomorrow, to have hope in the future.

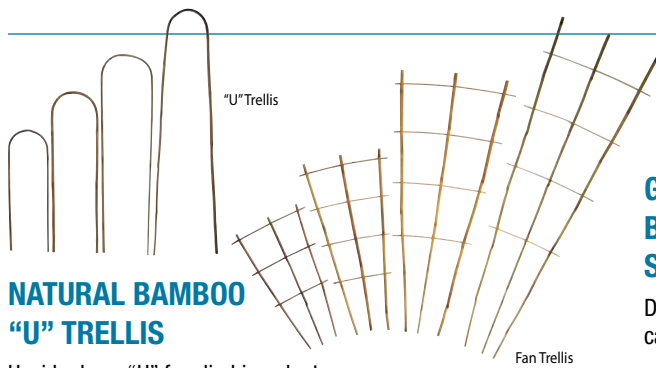

NATURAL BAMBOO "U" TRELLIS

Upside down "U" for climbing plants.

Item #	Length	Bale Qty.	Price (\$)
43466	18"	100	38.67
43467	24"	100	42.67
43468	30"	100	53.33
43469	36"	100	58.67
43470	42"	100	68.00
43471	48"	100	97.33

NATURAL BAMBOO FAN TRELLIS

An attractive way to display your climbing plants.

Item #	Length	Bale Qty.	Price (\$)
47960	18"	50	32.00
47961	24"	50	40.00
50020	30"	50	54.67
47962	36"	50	76.00
47963	48"	50	93.33

NATURAL BAMBOO TRIPOD TRELLIS

Item #	Length	Bale Qty.	Price (\$)
47964	24"	50	42.27
47965	36"	50	49.60
47966	48"	50	64.00



WIRE "S" HOOK

10 gauge galvanized steel used to extend hanging baskets – will hold up to 30 lbs.

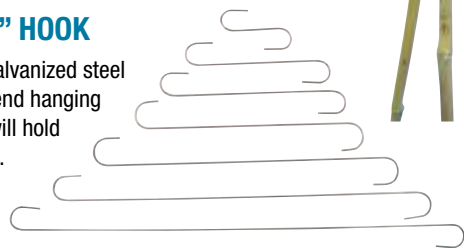

Item #	Length	Case Qty.	Price (\$)
43478	6"	25	0.23
43472	12"	25	0.28
43474	18"	25	0.33
43475	24"	25	0.37
43476	30"	25	0.41
43477	36"	25	0.47

GREEN DYED BAMBOO STAKES

Dyed forest green for camouflage.



Item #	Length	Diameter	Bale Qty.	Price (\$)
47943	1 1/2'	3/16"	2000	94.40
47944	2'	3/16"	1000	62.00
47945	2 1/2'	1/4"	1000	78.13
47946	3'	5/16"	1000	98.67
47947	4'	3/8"	500	80.00
47948	5'	7/16"	250	58.53
47949	6'	7/16"	250	65.73

GREEN DYED SPLIT POINTED BAMBOO

Round solid bamboo stakes with points.

Item #	Length	Diameter	Bale Qty.	Price (\$)
47950	8"	5/32"	5000	44.53
47951	12"	3/16"	5000	82.53
47952	16"	3/16"	5000	108.13
47953	18"	3/16"	5000	121.07
47954	24"	7/32"	2500	100.40

NATURAL BAMBOO FLAIR TRELLIS

Natural bamboo flair trellis with 2 vertical stakes.



Item #	Length	Bale Qty.	Price (\$)
47957	18"	100	45.33
47958	24"	100	56.00
47959	30"	100	72.00

NATURAL BAMBOO LADDER TRELLIS (Not pictured)

Natural bamboo ladder trellis with hooks on legs to fit in drain holes on 3 gallon pot for easy transport.

Item #	Length	Fits Container	Bale Qty.	Price (\$)
47956	36"	1 gallon	50	85.35



BAMBOO SUPPLY STAKES AND TRELLISES

Bamboo Supply has been supplying bamboo stakes and trellises to the nursery and greenhouse market for over 20 years.

NATURAL BAMBOO STAKES

The natural way to stake your plants.



Item #	Length	Diameter	Bale Qty.	Price (\$)
47918	2'	5/16"	1000	58.40
47919	2 1/2'	3/8"	500	46.40
47920	3'	3/8"	500	60.27
47921	3'	1/2"	250	42.00
47922	4'	3/8"	500	79.73
47923	4'	7/16"	250	50.27
47924	4'	1/2"	250	62.40
47925	5'	3/8"	500	90.53
47926	5'	7/16"	250	61.87
47927	5'	1/2"	250	79.87
47928	5'	5/8"	100	43.60
47929	6'	1/2"	200	75.60
47930	6'	5/8"	100	49.07
47931	6'	3/4"	100	75.60
47932	7'	1/2"	100	41.20
47933	7'	5/8"	100	54.80
47934	7'	3/4"	100	83.73
47935	8'	3/4"	50	47.07
47936	8	7/8"	50	58.80
47937	8'	1"	50	72.00
47938	9'	1"	50	81.33
47939	10'	1 1/8"	25	45.06
47940	12'	1 1/4"	25	65.73
47941	12'	1 3/8"	25	73.60
47942	15'	1 1/2"	20	46.67

Bale orders 8' or less can be shipped FedEx.



PLANT SUPPORT RINGS
(Used With Injection Pots)

- Features clip on fingers and will not rotate to sides
- Keeps the full uniform look of all plants and works with plant sleeves



Item #	Size	Dia/Depth	Color	Case Pk	Price (\$)
44672	4"	4 x 2 3/8"	Green	1680	207.00
44673	5"	5" x 3 1/4"	Green	1000	137.90
44674	6"	6" x 3 3/8"	Green	1500	179.90
44675	7"	7" x 3 3/8"	Green	1250	153.70
44676	8"	8" x 4 1/4"	Green	1250	159.30
44677	9"	9" x 4 5/8"	Green	500	78.00
44669	10"	10" x 5 1/4"	Green	500	81.70
44670	12"	12" x 7"	Green	450	175.40
44671	14"	14" x 9"	Green	400	160.10

*Leg Length dimensions.



THERMOFORM POT RINGS

- Features clip on fingers and will not rotate to sides
- Keeps the full uniform look of all plants and works with plant sleeves



Item #	Size	Dia/Depth	Color	Case Pk	Price (\$)
47399	6"	6" x 3 3/8"	Green	1400	191.00
47400	7"	7" x 3 3/4"	Green	1250	174.30
47401	8"	8" x 4 1/4"	Green	1250	179.90
48783	9"	9" x 4 5/8"	Green	500	86.20
48784	10"	10" x 5 1/4"	Green	500	90.00

*Leg Length dimensions.

TYNE PLANT RINGS

- Adjusts up or down the cane as required
- Circumference of the ring is in segments making it much easier to adjust plant stems as they are growing and to prevent damage



Item #	Mfr #	Description	Case Pk	Price (\$)
49795	PS62	6" dia.	50	29.50
49796	PS62	6" dia.	1000	256.50
49797	PS10	10" dia.	50	37.25
49798	PS10	10" dia.	1000	324.00



CUSTOM POLYETHYLENE PLANT RINGS & STAKES

Ker Plant Rings offer a significant savings over comparable metal or bamboo products.

- Made of 100% high density polyethylene for added rigid support
- Plant rings are available in a wide variety of sizes to choose from



Item #	Description	Case Pack	Price (\$)
Rings			
44849	4"D	1,000	82.75
44850	5"D	1,000	85.50
44851	6"D	1,000	86.75
44852	7"D	1,000	158.75
44853	8"D	1,000	249.50
44854	9"D	1,000	252.00
Stakes			
44855	12"L	7,500	360.00

TYNE CLIP-ON TRELLIS

The handy Clip-On Trellis slips easy onto the rim of most pots without interfering with the roots. The Clip-On will not clip onto rolled rim pots, but may be inserted directly into the soil. Measures 20" above pot.



Item #	Mfr #	Description	Case Pk	Price (\$)
41080	PS11G	Trellis, green	50	58.50

COUNTRY CRAFT WOOD TRELLIS

The Country Craft Wood Trellis is ideal for keeping vines contained, what's more, they make a nice presentation.

- Glued stapled and manufactured from pressure treated pine
- Clematis, Honeysuckle and Mandevilla are some of the most popular vines used
- Competitively priced, great for grower's of all sizes



Item #	Mfr #	Size	Case Pack	Price (\$)
43875	G-1	12"H x 6"W	100	.96
43876	G-2	24"H x 6"W	100	1.44
43877	G-3	36"H x 8"W	100	1.68
48530	G-2W	24"H x 10 5/8"W	100	1.74
48531	G-3W	36"H x 12 5/8"W	100	1.86

Custom sizes available upon request.

Gloeckner – 80 Plus Years and Still “Growing” Strong!

COTTON TWINE CONES

You can never have enough Cotton Twine in your greenhouse when the need arises – and it always does, be prepared.



Item #	Description	Price (\$)	
		1-9	10+
41431	Green, 4 ply, 2 lbs	20.00	18.00

HYACINTH STAKES

Select from the following sizes of round, green stained, pointed, northern hardwood stakes. Orders are sold in bundles of 1,000 stakes.



Item #	Description	Price (\$)		
		1,000	6,000-11,000	12,000+
41304	12"	40.75	36.75	32.50
41305	15"	45.75	41.00	36.50
41306	18"	53.00	47.75	42.50

One Call – Plants/Plugs, *Seeds*, Bulbs, and Supplies

- *Technical Expertise* – Gloeckner field reps possess a high level of valuable expertise to offer as a result of many years of industry and greenhouse production experience
- *Highest Seed Quality* – Proven quality with the latest enhancements available in the commercial flower industry
- *Wide Variety of Seeds* – Over 7,000 products available in-stock and more available upon request
- *Microgreen & Salad Greens* – Over 50 microgreens and salad greens for your Grown Local program
- *Fast Delivery, Great Service, Competitive Pricing* – For over 80 years, Gloeckner has been a valued business partner for the commercial growing community worldwide



Call 800-345-3787 for a copy of the latest catalog or go to www.fredgloeckner.com to order online.

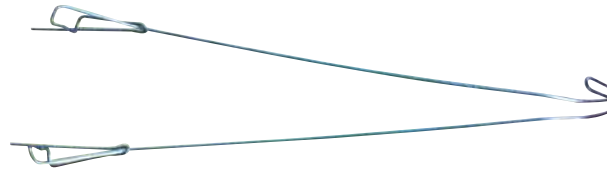

UNIVERSAL SNAP ON HANGER

This innovative product is an excellent way to save on valuable bench space. Made of quality galvanized steel, these pot hangers will hold up to an 8" diameter container, depending on the type and weight.

Item #	Size	Case Pk	Price (\$) 1-3 Cases	Price (\$) 4+ Cases
44839	19"L	250	276.75	231.25



STEM-CLIPS

Ideal for Staking Hydrangeas

The reusable Stem-Clip is easy to apply and will expand with the growth of the plant.

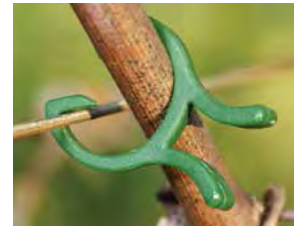

- No tools or training needed
- Saves time and labor

Item #	Description	Price (\$)			
		1M	5M	10M	50M
46474	Green, 3/4"	35.00	32.25	29.50	25.50

TWIST-EMS® TIES

Handy green paper covered plant ties feature wire running through the tape that makes them virtually unbreakable.



Item #	Size	Price (\$)/M				
		1,000	5,000	10,000	25,000	50,000
41429	4"L*	–	4.35	3.85	3.45	3.15
41430	8"L	9.25	8.25	7.45	6.75	5.20
41427	12"L	13.35	12.25	11.00	10.00	9.25
41428	16"L	18.50	16.35	14.75	13.40	12.25

*4" Twist-Ems sold in lots of 5,000. All other sizes sold in lots of 1,000.

See page 131-132 for more trellises and other plant supports.

TYNE CANE SUPPORTS

Cane Supports are designed to grip and hold canes upright and steady in pots, which helps prevent damage to plants. Cane Supports are not affected by wind and will stay vertical in all types of weather. Moreover, Cane Supports are so strong, the pots can be lifted by the cane!



Item #	Mfr #	Description	Case Pk	Price (\$)
49793	CBS1EP	Cane Supports	1,000	165.25
48452	CBS1	Cane Supports	100	18.75

TYNE CANE CAPS

- Made from a durable rubber material and will fit most sizes of canes
- Protects eyes and spectacles from injury and damage



Item #	Mfr #	Description	Case Pk	Price (\$)
49794	CC4EP	Green, fits all cones	250	28.75

TYNE CAP 'N' GROW

Soft rubber cap holds three bamboo stakes firmly in place to create a natural appearing teepee for training your plants. The versatile Cap 'N' Grow will support stakes from 2'-6' in length.



Item #	Mfr #	Description	Case Pk	Price (\$)
48453	PYR2	Cap 'N' Grow	100	16.25
49802	PYR2	Cap 'N' Grow	1000	142.75

1,000s of Grower Supplies and Equipment at www.fredgloeckner.com!

**ADVANTAGE®
200LS
RESPIRATOR**



Features a lighter, softer and more pliable combination of rubber and plastic materials for a secure and comfortable fit.

- AnthroCurve™ sealing surface reduces pressure points from the face seal area for improved comfort
- Design and materials assure added stability so the facemask will not collapse

Item #	Description	Price (\$)
41495	Unit	18.50
41061	Cartridge GME-P100, (2/pack)	31.25

**ADVANTAGE® 3200
RESPIRATOR**



Enhances worker performance through an innovative design that allows low breathing resistance.

- Standard nose cup reduces fogging in low temperatures or high humidity conditions
- Soft, pliable silicone facepiece lens has a scratch resistant coating and is engineered to be optically correct, giving the user superior visibility and peripheral vision

Item #	Description	Price (\$)
41496	Unit	181.95
41061	Cartridge GME-P100, (2/pack)	31.25

**COMFO CLASSIC®
RESPIRATOR**



Features SoftFeel® faceplate material for maximum comfort and protection.

- SoftFeel material is an exclusive formulation that improves the pliability and softness of the silicone used in the Comfo Classic Respirator
- Unique facesal design gives wearers an exceptional fit

Item #	Description	Price (\$)
41487	Unit	56.00
41060	Cartridge GMA-P100, (6/pack)	119.25

**NITRILE SOLVENT
RESISTANT GLOVES**



- Provides superior chemical resistance to many solvents
- Protects against abrasions, cuts, snags and punctures
- Features curved fingers, contoured palm and embossed grip for superior performance

Item #	Description	Price (\$) 1-11	Price (\$) 12+
41494	Pair	5.00	4.00

NEOPRENE FLOCK LINED GLOVES



- Provides high resistance to acids, alkalis, oil and grease
- Long lasting, flexible with high tensile strength

Item #	Description	Price (\$) 1-11	Price (\$) 12+
41493	Pair	7.50	6.50

**THE SAFETY ZONE
DISPOSABLE LATEX GLOVES**



- Ideal for handling flowers and plants where insecticide residues are present
- Lightly powdered for easy on, easy off
- Ambidextrous
- Ultra thin and super sensitive

Item #	Description	Case Pack	Price (\$) 1-9	Price (\$) 10+
41486	M/L*	100/box	10.25	9.25

*Fits sizes 7 1/2-9.

TYVEK SOFTWARE COVERALLS



Protective coveralls are ideal for greenhouse applications where chemical applications are widely used.

- Protective zippers on front hood, elastic wrists, and ankles
- Stops microporous particles better than other reusable garments
- Breathable fabric allows body heat to dissipate more readily in warm climates

Sold by the case only.

Item #	Size	Case Pack	Price (\$)
47065	Small	25	157.25
47066	Medium	25	157.25
47067	Large	25	157.25
47068	Extra Large	25	158.00

KASCO PROF 88 PROTECTIVE HELMET

The PROF 88 respirator is ideal for the protection of workers against agricultural processes which produce dusts, fumes, mists /organic vapors or during the spraying of toxic chemicals.



- Helmet features built in blower, batteries, filters, Lexan visor, polyamide collar, adjustable head-band, and a fiberglass shell with 3 coats of paint, the last coat being polyurethane
- Lightweight, comfortable and features wide visibility
- Innovative design sucks in air which is then purified for safe breathing and expired through the valves

Item #	Description	Price (\$)
45438	Self-contained Helmet Kit*	934.00
45424	Battery Charger (required)	184.00
Replacement Parts		
45425	Filters #ZA1/P3	45.50
45434	Battery #NC120/3x3	157.00
45428	Collar# 0309/79	69.25

*Includes helmet, 2# ZA1/P3 filters, dash-mount socket and cable, battery charger not included.

KASCO K80S-T8N

The helmet of choice when spraying pesticides inside a greenhouse and other areas where a 12-volt tractor system is not available.



- N.I.O.S.H approved for use in greenhouses
- Comes complete with Ontario (Canada) Hydro approved transformer charger
- Powerful 6-volt battery worn at the waist supplies power

Item #	Description	Price (\$)
45437	Helmet Kit*	924.00
45426	Replacement Filter #ZA2/PS	49.50

*Includes helmet, hose, fan-motor unit, belt, 2 #ZA2/P3 filters, batteries and charger.

FASTWRAPS

Quantity Discounts Available Upon Request.

The Fred C. Gloeckner Company is pleased to offer this new line of plant wraps in the catalog to complement our current representation of sleeves. DecoWraps are flexible and creative in providing bold designs for the new generation of the floral industry.



Metallic Fastwraps

The "go to" pot cover, versatile for any occasion.

Item #	Description	Case Pk	Price (\$)
Shiny Finish			
49809	4"	1,000	107.70
49810	4 1/2"	1,000	130.80
49811	6" Azalea	1,000	192.30
49812	6 1/2"	1,000	200.00
49813	8"	500	176.90
49814	8 1/2" Azalea	500	176.90
49815	10" PN	300	124.60
Satin Finish			
49816	4 1/2"	1,000	130.80
49817	6" Azalea	1,000	192.30
49818	6 1/2"	1,000	200.00
49819	8"	500	176.90
49820	8 1/2" Azalea	500	176.90
49821	10" PN	300	124.60

Please select from the following color choices: Silver, Evergreen, True Red, Gold, and Purple.



Kraft Fastwraps

A durable, thicker, heavier weight pot cover in vibrant colors • Offered in spring/summer, and fall/winter colors

Item #	Description	Case Pk	Price (\$)
Natural			
49822	4"	1,000	115.40
49823	4 1/2"	1,000	136.90
49824	6" Azalea	900	180.00

Please select from the following color choices: Purple, Natural, Dark Green, Basil Green, Orange, and Red.

Item #	Description	Case Pk	Price (\$)
White			
49825	4"	1,000	115.40
49826	4 1/2"	1,000	136.90
49827	6" Azalea	900	180.00

Please select from the following color choices: Lime, Yellow, Lavender, and Light Pink.



Edge Fastwraps

Unique registered design • Works great with bulb plants

Item #	Description	Case Pk	Price (\$)
49832	4 1/2"	1,000	152.30
49833	6" Azalea	1,000	236.90

Please select from the following color choices: Pink, Yellow, Green, Red, Purple, and Orange.

Allure Fastwraps

The premium pattern, complements any décor • Classical monochromatic design that allows you to style your everyday flowers

Item #	Description	Case Pk	Price (\$)
49828	4 1/2"	1,000	164.60
49829	6" Azalea	1,000	261.50

Please select from the following color choices: Yellow, Basil, Orange, Red, Purple, Light Pink, and Hot Pink.



Chevron Fastwraps

Classic sophistication, stylish simplicity • Soft geometric pattern and monochromatic soft colors makes this an ideal choice from spring to summer

Item #	Description	Case Pk	Price (\$)
49830	4 1/2"	1,000	156.90
49831	6" Azalea	900	250.80

Please select from the following color choices: Purple, Medium Pink, Orange, Yellow, and Basil.



Holiday Fastwraps

Fun, seasonal prints • Great for when an upgraded cover is needed

Item #	Description	Case Pk	Price (\$)
49834	Dotty Easter*, 4 1/2"	1,000	146.20
49835	Dotty Easter*, 6" AZA	1,000	230.80
49836	Glitter Hearts**, 4 1/2"	1,000	163.10
49837	Glitter Hearts**, 6" AZA	1,000	255.40
49838	Trail of Leaves, 4 1/2"	1,000	158.50
49839	Trail of Leaves, 6" AZA	1,000	260.00
49840	Dazzling Snowfall, 4 1/2"	1,000	163.10
49841	Dazzling Snowfall, 6" AZA	1,000	255.40

*Please select from the following colors: Pink, Lime, Yellow, and Lavender.

**Please select from the following colors: Red, Hot Pink.



STANDARD SPEED COVERS®

Plant covers from Highland Supply are a cost-effective and efficient way of creating superior value for your customers. There are many distinct sizes and flares available in the Speed Cover® line, suitable for just about every plant imaginable.

- It's so simple to create a professional look – just drop the plant in
- Covers require a minimum of storage space because they are nestable

Interior Color White

Item #	Mfr #	Description	Weight (lbs)	Case Pk	Price (\$)
44415	SC4-*1	4" Standard Flare	3.84	400	73.75
44416	SC45-*1	4 1/2" Standard Flare	4.6	400	73.75
45976	SC5-*1	5" High Flare	5.72	400	89.25
47243	SC5B-*1	5" Bulb Pan	3.84	400	89.25
44421	SC6-*1	6" Standard Flare	5.75	250	55.75
44420	SC6H-*1	6" High Flare	5.625	250	55.75
44422	SC6SH-*1	6" Short High Flare	5.075	250	55.75
44423	SC6TH-*1	6" Tall High Flare	7.2	250	55.75
47242	SC6B-*1	6" Bulb Pan	3.8	250	55.75
46469	SC6A-*1	6" Azalea	5.075	250	55.75
44425	SC65-*1	6 1/2" Standard Flare	5.75	250	55.75
44424	SC65H-*1	6 1/2" High Flare	6.325	250	55.75
44426	SC7-*1	7" High Flare	5.925	150	64.50
47244	SC8B-*1	8" Bulb Pan	4.26	150	71.50
44427	SC8-*1	8" High Flare	5.61	150	76.00
44419	SC10-*1	10" High Flare	8.46	150	90.00
47245	SC10B-*1	10" Bulb Pan	6.72	150	76.25
44418	SC10A-*1	10" Azalea	8.265	150	90.00
47246	SC10FH-*1	10" Foliage	6.27	100	60.00
47247	SC01H-*1	1 Gallon High Flare	5.145	150	56.50
47248	SCT1-*1	T1 Squat Pot	4.665	150	56.50

Stock colors available for immediate delivery include: Moss, Sherwood Green, and True Red. The following colors are available in limited sizes: Bittersweet, Emerald, Lavender, Nile, Orchid, Burgundy, Rose Pink, Pink, Sky Blue, Sunflower, Sunshine, and Wisteria.

Quantity discounts available upon request. Call for details.

Speed Covers Selection Guide	
Standard:	Recommended for (but not limited to) Cinneraria, Begonia
Bulb Pan:	Recommended for (but not limited to) Tulip, Hyacinthe, Daffodil
Short High Flare:	Recommended for (but not limited to) any low growing foliage plant
High Flare:	Recommended for (but not limited to) Azalea, Spath, Chrysanthemum
Tall High Flare:	Recommended for (but not limited to) Easter Lily, Asiatic Lily
Cushion Flare Size:	Recommended for (but not limited to) Mini Rose, Pothos, Philodendron

BRITE® SPEED COVERS® – Silver Interior

Item #	Mfr #	Description	Weight (lbs)	Case Pk	Price (\$)
44401	SC4-*SI1	4" Standard Flare	4.12	400	73.75
44402	SC45-*SI1	4 1/2" Standard Flare	5.206	400	73.75
44403	SC5-*SI1	5" High Flare	5.92	400	89.25
49890	SC5B-*SI1	5" Bulb Pan	4.12	400	89.25
44410	SC6-*SI1	6" Standard Flare	6.575	250	55.75
44408	SC6H-*SI1	6" High Flare	6.45	250	55.75
44409	SC6SH-*SI1	6" Short High Flare	5.525	250	55.75
44411	SC6TH-*SI1	6" Tall High Flare	7.725	250	55.75
44404	SC65-*SI1	6 1/2" Standard Flare	6.575	250	55.75
44412	SC65H-*SI1	6 1/2" High Flare	7.425	250	55.75
44405	SC7-*SI1	7" High Flare	4.665	150	64.50
44406	SC8-*SI1	8" High Flare	5.55	150	76.00
44400	SC10-*SI1	10" High Flare	9.675	150	87.50
47239	SC10B-*SI1	10" Bulb Pan	5.445	150	76.25
47240	SC01H-*SI1	1 Gallon High Flare	5.31	150	56.50
47241	SCT1-*SI1	T1 Squat Pot	4.89	150	56.25

Stock colors available for immediate delivery include: Moss, Gold, Purple Passion, and True Red. The following colors are available in limited sizes: Blue, Copper, Pink, and Silver.

EMBOSSED FOILS

Highland's sensational embossed foils are a beautiful and unique way to turn your everyday plants into premium gifts.

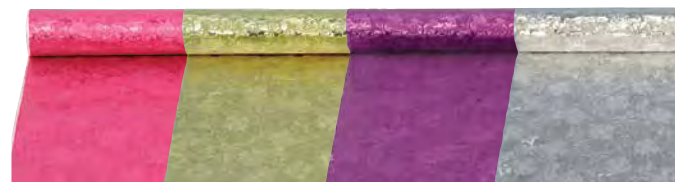

- Tear resistant; Holds their shape, even after wrapping
- Features a rich embossed surface texture

Camelot™ Embossed Foil – Backed in Silver

Item #	Description	Case Pk	Price (\$)
46496	20" x 50'	25 rolls/cs	114.50

Please specify from the following colors: Azalea, Black, Cranberry, Crystal Blue, Emerald, Flaming Fuscia, Gold, Lavender, Mallard, Moss, Navy, Pink, Purple, Red, Sage, Silver, Sonia, White, and Yellow.

Sold by the case only. Add \$12.50 for mixed colored cases.

Camelot™ Plastifoil®

Item #	Description	Case Pk	Price (\$)
46497	20" x 30'	25 rolls/cs	125.75

Please specify from the following colors: Exterior/Interior – Azalea, Black, Cranberry, Crystal Blue, Eggplant, Emerald, Flaming Fuscia, Gold/Gold, Lavender, Mallard/Mallard, Moss, Navy, Pink, Purple, Red/Red, Sage, Silver, Sonia, White, and Yellow. Backing color is Light Moss, unless otherwise indicated above.

Freight Prepaid on Orders Over 500 Lbs!

EARTH COVERSTM

Highland Supply's line of paper covers is a perfect "look" for today's marketplace.

- Paper materials are easy to work with and display just great
- Uses environmentally friendly based water based inks

7", 8", and 10" sizes available upon request.



Item #	Mfr #	Description	Wt (lbs)	Case Pk	Price (\$)
Highlight Color Outside (see below), Brown Interior					
Please specify color when ordering: Brick Red, China Glow, Chocolate, Cream, Green, Light Pink, Hot Pink, Purple, Bittersweet, Brown, Sherwood, or Yellow.					
47264	PSCD4-*BRN1	4" Standard Flare	7.16	400	98.50
47265	PSCD45-*BRN1	4 1/2" Standard Flare	9.64	400	98.50
47266	PSCD6-*BRN1	6" Standard Flare	11.325	250	76.75
47267	PSCD6H-*BRN1	6" High Flare	11.2	250	76.75
47268	PSCD6SH-*BRN1	6" Short High Flare	9.375	250	76.75
47269	PSCD6A-*BRN1	6" Azalea	9.625	250	76.75
47270	PSCD6TH-*BRN1	6" Tall High Flare	10.755	225	76.75
47271	PSCD65-*BRN1	6 1/2" Standard Flare	11.325	250	76.75
47272	PSCD65H-*BRN1	6 1/2" High Flare	9.775	250	76.75

Item #	Mfr #	Description	Wt (lbs)	Case Pk	Price (\$)
Highlight Color Outside (see below), Cream Interior					
Please specify color when ordering: Blue Ice, Lavender, Pink, Green, or Yellow.					
47273	PSCD4-*CM1	4" Standard Flare	7.16	400	98.50
47274	PSCD45-*CM1	4 1/2" Standard Flare	9.64	400	98.50
47275	PSCD6-*CM1	6" Standard Flare	11.325	250	76.75
47276	PSCD6H-*CM1	6" High Flare	11.2	250	76.75
47277	PSCD6SH-*CM1	6" Short High Flare	9.375	250	76.75
47278	PSCD6A-*CM1	6" Azalea	9.625	250	76.75
47279	PSCD6TH-*CM1	6" Tall High Flare	10.755	225	76.75
47280	PSCD65-*CM1	6 1/2" Standard Flare	11.325	250	76.75
47281	PSCD65H-*CM1	6 1/2" High Flare	9.775	250	76.75

Item #	Mfr #	Description	Wt (lbs)	Case Pk	Price (\$)
Meadow Flowers Print, Brown Interior					
51878	PSC4-MFR/BRN1	4" Standard Flare	7.16	400	123.00
51879	PSC45-MFR/BRN1	4 1/2" Standard Flare	9.64	400	123.00
51880	PSC6-MFR/BRN1	6" Standard Flare	11.325	250	92.25
51881	PSC6H-MFR/BRN1	6" High Flare	11.2	250	92.25
51882	PSC6SH-MFR/BRN1	6" Short High Flare	9.375	250	92.25
51883	PSC65-MFR/BRN1	6 1/2" Standard Flare	11.325	250	92.25
51884	PSC65H-MFR/BRN1	6 1/2" High Flare	9.775	250	92.25
51885	PSC7-MFR/BRN1	7" Standard Flare	11.22	150	90.00
51886	PSC8-MFR/BRN1	8" Standard Flare	10.095	150	108.50
51887	PSC10-MFR/BRN1	10" Standard Flare	12.15	150	129.25

Item #	Mfr #	Description	Wt (lbs)	Case Pk	Price (\$)
Jute Natural Print, Brown Interior					
51888	PSC4-JTNT/BRN1	4" Standard Flare	7.16	400	123.00
51889	PSC45-JTNT/BRN1	4 1/2" Standard Flare	9.64	400	123.00
51890	PSC6-JTNT/BRN1	6" Standard Flare	11.325	250	92.25
51891	PSC6H-JTNT/BRN1	6" High Flare	11.2	250	92.25
51892	PSC6SH-JTNT/BRN1	6" Short High Flare	9.375	250	92.25
51893	PSC65-JTNT/BRN1	6 1/2" Standard Flare	11.325	250	92.25
51894	PSC65H-JTNT/BRN1	6 1/2" High Flare	9.775	250	92.25
51895	PSC7-JTNT/BRN1	7" Standard Flare	11.22	150	90.00
51896	PSC8-JTNT/BRN1	8" Standard Flare	10.095	150	108.50
51897	PSC10-JTNT/BRN1	10" Standard Flare	12.15	150	129.25

Item #	Mfr #	Description	Wt (lbs)	Case Pk	Price (\$)
Patriotic Print, White Interior					
51898	PSC4-PAT/W1	4" Standard Flare	7.16	400	123.00
51899	PSC45-PAT/W1	4 1/2" Standard Flare	9.64	400	123.00
51900	PSC6-PAT/W1	6" Standard Flare	11.325	250	92.25
51901	PSC6H-PAT/W1	6" High Flare	11.2	250	92.25
51902	PSC6SH-PAT/W1	6" Short High Flare	9.375	250	92.25
51903	PSC65-PAT/W1	6 1/2" Standard Flare	11.325	250	92.25
51904	PSC65H-PAT/W1	6 1/2" High Flare	9.775	250	92.25
51905	PSC7-PAT/W1	7" Standard Flare	11.22	150	90.00
51906	PSC8-PAT/W1	8" Standard Flare	10.095	150	108.50
51907	PSC10-PAT/W1	10" Standard Flare	12.15	150	129.25



FLEXIBLE FLOWER NET

The Flexible Flower Net is a great and inexpensive way to protect your plants.



Item #	Box Pack	Price (\$)		
		1-4 Boxes	5+ Boxes	Bulk (10,000)
41203	2,000	49.00	44.00	N/A
41202	10,000	N/A	N/A	190.00

SPEED SHEETS®

Clear, crisp, pressure sensitive floral wrap ideal for dried, fresh, and silk bouquets.



- One size sheet adjusts to different size bunches
- Seals with a pressure sensitive adhesive strip that remains secure even in water; nothing to remove or discard

Item #	Mfr #	Description	Weight (lbs)	Case Pk	Price (\$)
51908	SS2014Q1-C5	20" x 14" Clear	31.6	4,000	453.75
51909	SS2024Q1-C5	20" x 24" Clear	27.4	2,000	369.50
51910	SS715Q-C5	7" x 15" Clear	15	5,000	256.50





VERTPAC has been manufacturing high quality plant sleeves for the nursery trade for decades. With its cutting-edge operational facilities, VERTPAC has been able to offer the widest selection of sleeves in the industry.



Paper Sleeves

The Original Plant Sleeve!

- Paper is still the preferred choice for its rigidity, durability and protective qualities
- Made with heavy-duty kraft wet strength paper and strong, non-toxic glue
- Available in the traditional nested, unnested or in a system style with a wooded header



Item #	Pot Size	Bottom Width	Top Width	Height	Case Pk	Price/M (\$)
45096	4" - 4 1/2"	5 1/2"	10"	12"	250	89.00
45097	4" - 4 1/2"	5 1/2"	12"	15"	250	94.00
45098	4" - 4 1/2"	5 1/2"	13"	18"	250	100.00
47130	4" - 4 1/2"	5 1/2"	15"	18"	250	111.40
47131	5" - 5 1/2"	6"	18"	18"	250	131.50
47132	5" - 5 1/2"	6"	18"	24"	250	135.70
47133	5" - 5 1/2"	6"	22"	24"	250	161.40
47134	5" - 5 1/2"	6 1/2"	19"	30"	250	154.30
47136	6" - 6 1/2"	8"	14"	16"	250	109.00
45102	6" - 6 1/2"	8"	14"	18"	250	113.00
45104	6" - 6 1/2"	8"	16"	18"	250	124.00
47137	6" - 6 1/2"	8"	18"	18"	250	134.30
47138	6" - 6 1/2"	8"	18"	20"	250	137.10
45108	6" - 6 1/2"	8"	20"	20"	250	140.00
45105	6" - 6 1/2"	8"	16"	21"	250	124.00
45103	6" - 6 1/2"	8"	16"	24"	250	134.00

Item #	Pot Size	Bottom Width	Top Width	Height	Case Pk	Price/M (\$)
47139	6" - 6 1/2"	8"	18"	24"	250	142.90
45107	6" - 6 1/2"	8"	20"	24"	250	156.00
47135	6" - 6 1/2"	7 1/2"	22"	24"	250	161.40
47140	6" - 6 1/2"	8"	24"	24"	250	177.10
45106	6" - 6 1/2"	8"	17"	30"	250	151.00
47141	6" - 6 1/2"	8"	20"	30"	250	170.00
47142	6" - 6 1/2"	8"	24"	30"	250	191.00
45109	6" - 6 1/2"	8"	20"	36"	250	199.00
47143	6" - 6 1/2"	8"	24"	36"	250	222.90
47144	7" - 7 1/2"	9"	18"	24"	250	150.00
47145	7" - 7 1/2"	9"	22"	24"	250	172.90
47146	7" - 7 1/2"	9"	24"	24"	250	182.90
45110	7" - 7 1/2"	9"	20"	30"	250	175.70
47147	7" - 7 1/2"	9"	24"	30"	250	200.00
45111	7" - 7 1/2"	9"	20"	36"	250	202.90
47148	7" - 7 1/2"	9"	24"	36"	250	230.00
47149	7" - 7 1/2"	9"	30"	36"	250	271.40
45063	8" - 9"	10 1/2"	22"	24"	250	176.00
47108	8" - 9"	10 1/2"	24"	24"	250	188.60
45064	8" - 9"	10 1/2"	22"	30"	250	191.00
48528	8" - 9"	10 1/2"	24"	30"	250	205.70
48529	8" - 9"	10 1/2"	27"	30"	250	221.00
45065	8" - 9"	10 1/2"	22"	36"	250	221.00
47109	8" - 9"	10 1/2"	24"	36"	250	235.70
47110	8" - 9"	10 1/2"	27"	36"	250	257.00
47111	8" - 9"	10 1/2"	30"	36"	250	277.10
45066	8" - 9"	10 1/2"	24"	42"	250	261.00
47112	8" - 9"	10 1/2"	27"	42"	250	282.90
45067	8" - 9"	10 1/2"	24"	48"	250	296.00
47113	8" - 9"	10 1/2"	27"	48"	250	321.40
45068	10"	13 1/2"	22"	24"	250	193.00
47114	10"	13 1/2"	24"	24"	250	201.00
45069	10"	13 1/2"	22"	30"	250	210.00
47115	10"	13 1/2"	24"	30"	250	211.40
47116	10"	13 1/2"	27"	30"	250	240.00
47117	10"	13 1/2"	30"	30"	250	259.00
45070	10"	13 1/2"	24"	36"	250	253.00
47118	10"	13 1/2"	27"	36"	250	274.00
47119	10"	13 1/2"	30"	36"	250	267.10
47120	10"	13 1/2"	34"	36"	250	322.90
45071	10"	13 1/2"	24"	42"	250	277.00
47121	10"	13 1/2"	30"	42"	250	324.30
45072	10"	13 1/2"	24"	48"	250	310.00
47122	10"	13 1/2"	30"	48"	100	361.40
45073	10"	13 1/2"	25"	60"	100	484.00
45074	10"	13 1/2"	28"	72"	100	614.00
47123	10"	14"	26"	48"	100	332.90
47124	10"	14"	26"	60"	100	502.90
45077	10" - 3 gal	15"	25"	36"	100	271.40
45078	10" - 3 gal	15"	25"	42"	100	279.10
47125	10" - 3 gal	15"	25"	48"	100	331.40

Item #	Pot Size	Bottom Width	Top Width	Height	Case Pk	Price/M (\$)
45079	10" - 3 gal	15"	25"	60"	100	502.90
45080	12"	16"	24"	36"	100	240.00
47126	12"	16"	26"	36"	100	270.00
45081	12"	16"	24"	42"	100	297.00
47127	12"	16"	30"	42"	100	341.40
45082	12"	16"	25"	48"	100	340.00
47128	12"	16"	30"	48"	100	382.90
45083	12"	16"	28"	60"	100	556.00
45084	12"	16"	30"	72"	100	680.00
47129	14"	19"	30"	42"	100	364.00
45085	14"	19"	30"	48"	100	407.00
45086	14"	19"	30"	60"	100	619.00
45087	14"	19"	30"	72"	100	729.00
45088	14"	19"	35"	84"	100	1,057.00
45089	14"	19"	40"	96"	100	1,323.00

Satin Sleeves

- Made from durable high density polyethylene with vent holes for efficient air circulation
- Handy wooden header and belt clip system makes sleeving fast and easy for one person



Item #	Pot Size	Bottom Width	Top Width	Height	Case Pk	Price/M (\$)
47161	3" - 3 1/2"	4 1/2"	10"	12"	1000	51.00
45130	4" - 4 1/2"	5 1/2"	11"	12"	1000	51.00
45131	4" - 4 1/2"	5 1/2"	12"	15"	1000	53.00
45132	4" - 4 1/2"	5 1/2"	13"	18"	1000	66.00
47162	4" - 4 1/2"	5 1/2"	14"	24"	1000	90.00
45133	4 1/2" - 5"	6"	15"	15"	1000	64.00
47163	4 1/2" - 5"	6"	11"	18"	1000	61.00
45134	5" - 5 1/2"	7"	15"	15"	1000	66.00
45135	5" - 5 1/2"	7"	15"	18"	1000	74.00
47164	6" - 6 1/2"	8"	14"	15"	1000	66.00
45139	6" - 6 1/2"	8"	16"	18"	1000	67.00
45143	6" - 6 1/2"	8"	18"	18"	1000	78.60
45140	6" - 6 1/2"	8"	16"	20"	1000	70.00
45144	6" - 6 1/2"	8"	20"	20"	1000	84.00
47165	6" - 6 1/2"	8"	22"	20"	1000	97.10
45150	6" - 6 1/2"	8"	24"	20"	1000	107.00
45141	6" - 6 1/2"	8"	16"	24"	1000	81.00
45145	6" - 6 1/2"	8"	20"	24"	1000	104.00

Continued on next page

Satin Sleeves – continued

Item #	Pot Size	Bottom Width	Top Width	Height	Case Pk	Price/M (\$)
45148	6" - 6 1/2"	8	22"	24"	1000	111.40
45151	6" - 6 1/2"	8	24"	24"	1000	117.00
47166	6" - 6 1/2"	8	27"	24"	1000	124.30
47167	6" - 6 1/2"	8	20"	27"	1000	115.70
47168	6" - 6 1/2"	8	24"	27"	1000	122.90
45142	6" - 6 1/2"	8	17"	30"	1000	119.00
45146	6" - 6 1/2"	8	20"	30"	1000	137.00
45149	6" - 6 1/2"	8	22"	30"	1000	157.00
45152	6" - 6 1/2"	8	24"	30"	1000	157.00
45147	6" - 6 1/2"	8	20"	34"	1000	161.00
48511	6" - 6 1/2"	8	24"	34"	1000	195.70
45153	7" - 7 1/2"	9	22"	24"	1000	114.00
47169	7" - 7 1/2"	9	22"	26"	1000	118.60
45154	7" - 7 1/2"	9	24"	30"	1000	150.00
47170	7" - 7 1/2"	9	24"	34"	1000	197.10
45115	8"	10 1/2"	22"	20"	1000	101.00
45116	8"	10 1/2"	22"	24"	1000	109.00
45121	8"	11"	27"	24"	1000	128.00
45117	8"	10 1/2"	24"	30"	1000	160.00
45119	8"	10 1/2"	27"	30"	1000	174.00
45120	8"	10 1/2"	30"	30"	1000	189.00
45118	8"	10 1/2"	24"	34"	1000	200.00
47150	8"	10 1/2"	27"	34"	1000	219.00
47151	8"	10 1/2"	30"	34"	1000	236.00
47152	9"	12 1/2"	30"	30"	1000	199.00
45122	10"	13 1/2"	24"	24"	1000	123.00
45126	10"	13 1/2"	27"	24"	1000	137.00
47153	10"	13 1/2"	24"	27"	1000	143.00
45124	10"	13 1/2"	24"	30"	1000	174.00
45125	10"	13 1/2"	27"	30"	1000	181.00
45127	10"	13 1/2"	30"	30"	1000	199.00
47154	10"	13 1/2"	24"	34"	1000	219.00
47155	10"	13 1/2"	27"	34"	1000	235.70
45128	10"	13 1/2"	30"	34"	1000	253.00
45129	12"	16"	30"	30"	1000	223.00
47157	12"	16"	30"	34"	1000	267.00
47158	14"	19"	27"	30"	1000	220.00
47159	14"	19"	30"	30"	1000	231.00
47160	14"	19"	27"	34"	1000	268.60

Fiber-Aire Sleeves

- Combines functionality with an attractive presentation
- Fully breathable sleeve for optimal circulation
- Durable and able to withstand dampness and watering
- Sleeves come stapled to a wooden header which can be attached to a belt clip or counter clamp for added ease of sleeving plants



Item #	Pot Size	Bottom Width	Top Width	Height	Case Pk	Price/M (\$)
48512	6" - 6 1/2"	8"	16"	18"	1000	
48513	6" - 6 1/2"	8"	20"	20"	1000	
48514	6" - 6 1/2"	8"	16"	24"	1000	
48515	6" - 6 1/2"	8"	20"	24"	1000	
48516	6" - 6 1/2"	8"	22"	24"	1000	
47171	8"	10 1/2"	22"	24"	1000	
47172	8"	10 1/2"	24"	30"	1000	
47173	10"	13 1/2"	24"	24"	1000	
47174	10"	13 1/2"	24"	30"	1000	

Call for Quotes.

ShoCase Sleeves

- Combines enhanced breathability with exceptional visibility
- Half-fiber, half crystal-clear polypropylene is ideal for use in a retail environment
- Traditional white fiber backing with a crystal clear polypropylene front
- Sleeves come stapled to a wooden header which can be attached to a belt clip or counter clamp for added ease of sleeving plants

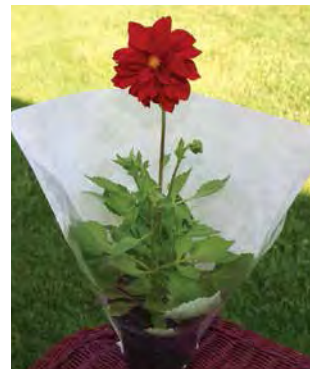

Available in a wide assortment of sizes, call for additional information.

Printed Paper

- Ideal for identifying plants for shipping convenience and accuracy
- Ideal for marking special instructions or for branding purposes
- Choose from seasonal prints (see below) or customize your sleeves with your company logo

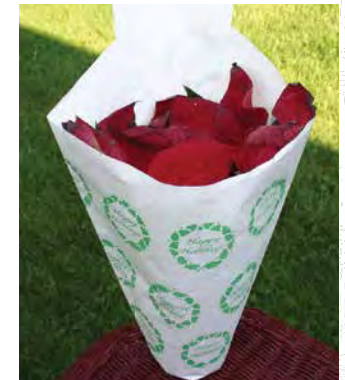

Red Candy Cane



Green Wreath



Red Poinsettia

Item #	Pot Size	Bottom Width	Top Width	Height	Case Pk	Price/M (\$)
48517	4" - 4 1/2"	5 1/2"	13"	18"	1000	
48518	6" - 6 1/2"	8"	20"	20"	1000	
48519	6" - 6 1/2"	8"	20"	24"	1000	
48520	6" - 6 1/2"	8"	16"	30"	1000	
48521	7" - 7 1/2"	9"	24"	24"	1000	
48522	8" - 9"	10 1/2"	22"	24"	1000	
48523	8" - 9"	10 1/2"	22"	30"	1000	
48524	8" - 9"	10 1/2"	22"	36"	1000	
48525	10"	13 1/2"	24"	24"	1000	
48526	10"	13 1/2"	24"	30"	1000	
48527	10"	13 1/2"	24"	36"	1000	

Call for Quotes.

Please specify Red Candy Cane, Red Poinsettia or Green Wreath when ordering.

Volume discounts available as follows: 5% off orders over 5,000 sleeves; 10% for orders over 10,000 sleeves. Mixed sizes and styles acceptable to qualify for volume discounts.

Additional \$10.00 per M for nesting.

Custom printing with logos and care instructions available upon request.

Boxing available upon request.

Note: Boxing charge will apply.

Sign Up for the Gloeckner "Growing Places" e-Newsletter

- New products
- Educational info
- Industry news
- Tips from the "Field"
- And more

Contact us at info@fredgloeckner.com to get on the recipient list.



SENSAPHONE SENTINEL CLOUD-BASED MONITORING SYSTEM



The cloud-based Sentinel allows you to monitor remote facilities and environments and check critical conditions of your sensitive commodities with a high degree of certainty. It takes the burden of managing your system by giving you access to your readings from anywhere using a simple, powerful web-based interface and mobile app. The Sentinel system stores all sensor readings in the cloud, which provides unlimited information storage.

- Supervised internet connection assures the Sentinel is online and monitoring at all times
- Manage an unlimited number of devices from one account
- Monitor up to 12 external sensors or equipment status
- Enhanced data logging capabilities allow user to print, graph, or export accurate historical records
- Receive an e-mail, phone call, or text when an alarm is detected
- Real-time status updates available
- Ethernet-based but has cellular coverage option available from leading carriers
- Includes battery back-up

Item #	Description	Price (\$)
51923	Unit, PH SCD-1200	599.95



Outdoor



Indoor

Accessories

Item #	Description	Price (\$)
Waterproof Temperature Monitoring Sensor (Outside Use)		
-20°F to 176°F, +/-1°F • Programmed to trigger an alarm when conditions exceed the set high or low temperature limits • Mounts easily anywhere		
51924	Unit, PH FGD-0101	30.00
Room Temperature Sensor (Indoor Use)		
0°F to 120°F, +/-1°F • Programmed to trigger an alarm when conditions exceed the set high or low temperature limits		
51925	Unit, FGD-0100	30.00

SENSAPHONE 400 & 800 REMOTE MONITORING AND ALARM NOTIFICATION SYSTEMS

No Monthly Fees!

Sensaphone Systems are an easy, inexpensive way to monitor your greenhouse or some other remote facility.



400



800

- **Input Zones** – Supports temperature sensors from -20°F–150°F
- **Alarm Notification** – Notifies 4 or 8 numbers depending on unit
- **Voice Messages** – Built-in vocabulary for keypad programming and sensor readings
- **Microphone** – Internal microphone for custom messaging
- **Remote Access** – Call in with any touch-tone phone for status check
- **Local Access** – Keypad and speaker for local programming
- **Power Supply** – Comes with plug-in power supply; 24 hour battery backup using 6 size C alkaline batteries (not included)

Item #	Description	Price (\$)
Sensaphone® 400		
Four notification phone numbers • Four external inputs		
48496	Unit	395.00
Sensaphone® 800		
Ideal when you need to notify more people, 8 phone numbers • Eight external inputs		
48497	Unit	595.00
Remote Temperature Sensor FCD0101		
48498	Unit	30.00

THERMALARM III TEMPERATURE ALARM THERMOMETER

- Waterproof temperature sensor can be adjusted for both high and low temperatures
- Thermometer will automatically ring a bell or buzzer in your home or some other convenient place when the temperature in your greenhouse or cooler drops below, or rises above a pre-determined temperature
- Can be used in conjunction with the Sensaphone Monitoring System.



Item #	Description	Price (\$)
41548	Unit	53.75

Thermalarms are built to operate on low-voltage, low-current alarm systems (typically 6-24 volts DC @ 0.5 amps of current or less). A simple relay circuit should be used in systems exceeding 0.5 amps of current.

Specifications

Calibration Accuracy: +/-2°F
 Scale: 30°F–120°F in 35°F increments
 High/Low Limit Usable Range: 35°F–110°F
 Housing Diameter: 4 1/2"

TAYLOR

BI-THERM THERMOMETERS

- Shock proof, anti-parallax soil thermometer
- Temp range from 0°F–220°F
- Stainless steel stems assure long-life



Item #	Description	Price (\$)
41043	1' dial w/5" stem	16.25
41044	2' dial w/8" stem	32.00

TAYLOR

5132 WALL THERMOMETER

Lifetime Warranty

- Features protective caps
- Environmentally safe fluid
- Concave design increases readability
- Accurate from -60°F–120°F (-50°C–50°C)
- Weather resistant and rustproof
- Durable metal construction
- Bright, colorful graphics



Item #	Description	Price (\$) 1-11	Price (\$) 12+
41010	Model 5132	6.50	5.75

TAYLOR

1105 WALL THERMOMETER

- Heavy-duty metal construction with white powder coat
- Accurate from -30°F–120°F (-40°C–50°C)
- For the budget minded grower



Item #	Description	Price (\$) 1-5	Price (\$) 6+
41002	Model 1105	20.75	18.75

MINI MAX THERMOMETER

This all-purpose indoor/outdoor thermometer registers the day's high and low temperature as well as the current temperature. The pin rises as the temperature changes indicating on the right to show the highest temperature while the marker on the left records the day's low.

- Features Fahrenheit and Centigrade readings
- Convenient push button resets both high and low indicators for the next day
- Accurate from -30°F–120°F (-30°C–50°C)



Item #	Description	Price (\$) 1-5	Price (\$) 6+
41347	Unit	13.50	11.50



Fred C.
Gloeckner
& Company,
Incorporated



GLITTER

All that glitters can be gold when it comes to incremental sales of Gloeckner Glitters for your business. By using the specially formulated clear glue and then applying laser cut octagonal glitters, you can create a whole new enticing presentation for your customers. Gloeckner Glitters look particularly great on red and pink poinsettias, not to mention additional creations when used in combination with the Fantasy Colors II™ featured on page 142.

Item #	Color	Price (\$)	Item #	Color	Price (\$)
500 ml Jar					
41132	Blush Pink	20.50	41147	Red Regal	20.50
41133	Brilliant Gold	20.50	41148	Silver Chrome	20.50
41134	Copper Bronze	20.50	41149	Turquoise Blue	20.50
41135	Dark Blue	20.50	41140	Neon Canary Yellow	24.25
41136	Emerald Green	20.50	41141	Neon Fuschia	24.25
41137	Iridescent	20.50	41142	Neon Lime Green	24.25
41138	Midnight Black	20.50	41143	Neon Pink	24.25
41139	Multi-Color	20.50	41144	Neon Purple	24.25
41146	Plum	20.50	41145	Neon Salmon	24.25
5 Kilo Box					
41124	Blush Pink	206.25	41130	Red Regal	206.25
41125	Brilliant Gold	206.25	41131	Silver Chrome	206.25
41126	Copper Bronze	206.25	46486	Turquoise Blue	206.25
41127	Dark Blue	206.25	46487	Neon Fuschia	223.25
41128	Emerald Green	206.25	46498	Neon Pink	223.25
41129	Iridescent	206.25	46488	Neon Purple	223.25
46489	Plum	206.25	46499	Neon Salmon	223.25

CLEAR GLUE

- Dries clear
- Won't harm plants
- Water-based

Item #	Description	Price (\$)	Item #	Description	Price (\$)
41091	Ready-to-use, 1 liter	18.00	41104	Concentrate, 10 liter	245.00
41102	Concentrate, 1 liter	31.00	41103	Pump spray head	4.25



CURLY GLITTERED TING TING

Ting Ting products are a great opportunity to add three dimensional height and interest to your poinsettias, other potted plants, floral arrangements, centerpieces, and more.

- Easy-to-use Ting Ting adds a 3D look to accentuate your decorating theme or special project
- 9 attractive glittered colors
- Comes packed 24" to 28" lengths



Item #	Color	Description	Price (\$)
Curly - Packed 24"-28" Assorted Lengths			
49167	Gold	1200 stems/case	58.25
49168	Green	1200 stems/case	58.25
49169	Black	1200 stems/case	58.25
49170	Blue	1200 stems/case	58.25
49171	Champagne	1200 stems/case	58.25
49172	Red	1200 stems/case	58.25
49173	White	1200 stems/case	58.25
49174	Fuchsia	1200 stems/case	58.25
49175	Silver	1200 stems/case	58.25

Ting Ting is also available in bulk pack 4500 stems/case (no mixed color cases). Call for details, prices, and minimum requirements.

**Need Personal Assistance?
Call 800-345-3787**

FANTASY COLORS II™ *An Extreme Makeover for Your Poinsettias!*



Fantasy Colors II are the next generation of safe, color dyes that allow you to create a whole new look, form and feel for your poinsettias. Customers will be excited with the added range of your poinsettia offerings and you'll be equally excited with this new revenue generating opportunity.

- Fantasy Colors will not harm plants and will maintain their beautiful appearance as long as the plant is alive
- Typically works best on white, cream, apricot, light pink and marble poinsettias
- Available in easy-to-use spray bottle and more for your money concentrate formula

Stunning Colors to Make Your Poinsettias Pop!

- Apricot
- Plum
- Lilac
- Orange
- Fuschia
- Turquoise
- Blue
- Yellow



Ready to Use Spray Bottle – 1 Liter

Item #	Color	Price (\$)		
		1-9 Liters	10-29 Liters	30+ Liters
42514	Apricot	31.00	27.75	25.25
42515	Blue	31.00	27.75	25.25
42517	Fuchsia	31.00	27.75	25.25
42519	Lilac	31.00	27.75	25.25
42520	Orange	31.00	27.75	25.25
42521	Plum	31.00	27.75	25.25
42522	Turquoise	31.00	27.75	25.25
42523	Yellow	31.00	27.75	25.25

*Spray head not included.

Concentrate Formula – 1 Liter

Item #	Color	Price (\$)		
		1-9 Liters	10-29 Liters	30+ Liters
42504	Apricot	65.75	62.75	59.00
42505	Blue	65.75	62.75	59.00
42507	Fuchsia	65.75	62.75	59.00
42509	Lilac	65.75	62.75	59.00
42510	Orange	65.75	62.75	59.00
42511	Plum	65.75	62.75	59.00
42512	Turquoise	65.75	62.75	59.00
42513	Yellow	65.75	62.75	59.00

**Ethanol additive required for concentrate application – see pricing on right.



Accessories

Item #	Description	Price (\$)
42500	1 liter Ethanol	8.50 ea
46473	1 gallon Ethanol	22.25 ea
	4 x 1 gallon of Ethanol	20.00 ea
41103	Spray Pump Head	4.25 ea

Fantasy Colors™ Recipes for Poinsettias

Visit www.fredgloeckner.com, click on the Grower Supplies tab on top, and look for the link to our Fantasy Colors 15-page recipe booklet.

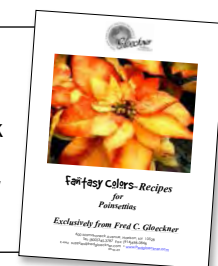

SHIMMER POWDERS

Shimmer Powders are a non-toxic natural product that adds a whole new look and dimension to poinsettias, bouquets, potted and foliage crops and more.

- Shimmer Powders work great in combination with ethanol, Fantasy Colors (see page 142), and Clear Glue (see page 141)
- Gold Shimmer is the most popular color and gives an elegant, gilded look to poinsettia bracts and leaves
- Silver Shimmer gives a silvery-white snow effect and looks best on dark colored poinsettias
- Shimmer Powders will not harm plants and will maintain their beautiful appearance as long as the plant is alive



Gold Shimmer with Ethanol on a Red Poinsettia



Silver Shimmer Mixed with Fantasy Color Fuchsia on a White Poinsettia



Gold Shimmer Mixed with Fantasy Color Yellow on a White Poinsettia



Silver Shimmer Mixed with Fantasy Color Blue on a White Poinsettia



Silver Shimmer Mixed with Fantasy Color Orange on a Pink Poinsettia



Gold Shimmer Mixed with Fantasy Color Lilac on a White Poinsettia



Blue Shimmer Mixed with Ethanol on a White Poinsettia with Iridescent Glitter (from the movie "FROZEN")

Item #	Color	Price (\$)
500 ml (25 Tablespoon) – Covers Approx. 1,000-1,200, 6" Pots		
41095	Gold	135.00
41101	Silver	135.00
41098	Opal	135.00
48587	Blue	135.00
48590	Red Velvet	135.00
48593	Bronze	135.00
48596	Copper	135.00

Plant Makeovers = Big Profits

Gloeckner's plant stylizing products not only look great, they generate incremental profits for your business. Refer to pages 141-143 for the full line of Fantasy Colors, Shimmer Powders, Glitters and accessories.



SNOW POWDER

Who says you have to wait until winter to enjoy the beauty of snow? With Snow Powder, in a matter of minutes, you can transform your flowers, ornaments, cork, trees and more into your own beautiful creation.

- Naturally safe, flame retardant
- Easy-to-use
- Fast drying, self-adhesive, semi-permanent

Item #	Description	Price (\$)
46530	1000 ml jar	10.00
46531	11.5 Kilo bag	123.25



How Do I Snow?

- Moisten the surface area you want to cover by misting with water or Fantasy Glue
- Sprinkle the desired area with snow
- Let dry for approximately 2 minutes and enjoy!
- Easy to clean with just soap and water



**NUTRICULTURE®
FERTILIZER 5 LB BAGS**

Ideal for Retail Sales!

Sell your retail customers the same fertilizer you use commercially with these convenient 5 pound bags.

General Purpose 20-10-20

Specially formulated as a general purpose feed for use on ornamental plants, small shrubs, fruits, and vegetables.

Item #	Formula	Case Pk	Price (\$)
47379	20-10-20	6 x 5 lb	41.30

General Purpose 20-20-20

General purpose high-phosphate feed for ornamental plants, small shrubs, fruits and vegetables.

Item #	Formula	Case Pk	Price (\$)
47380	20-20-20	6 x 5 lb	45.00

Hi Cal-Mag Vegetable 12-5-19

Specially formulated for vegetables, peppers, tomatoes, and fruiting crops • Extra calcium for use in areas with soft water

Item #	Formula	Case Pk	Price (\$)
49776	12-5-19	6 x 5 lb	40.00

Vegetable Cal-Mag 14-5-22

Specially formulated for vegetables, peppers, tomatoes, and fruiting crops • Formulated for hard water

Item #	Formula	Case Pk	Price (\$)
49205	14-5-22	6 x 5 lb	45.00

Cal-Mag Special 17-5-17

Specially formulated for tomato and vegetable crops that require calcium and magnesium.

Item #	Formula	Case Pk	Price (\$)
49777	17-5-17	6 x 5 lb	43.75

Mag-Iron Special 18-6-18

A high magnesium and iron combination formulation for high media pH environments.

Item #	Formula	Case Pk	Price (\$)
47378	18-6-18	6 x 5 lb	45.00

Cal-Mag General Purpose 20-5-20

General feed for a variety of crops • High-nitrate nitrogen is ideal for plants in low light conditions

Item #	Formula	Case Pk	Price (\$)
49778	20-5-20	6 x 5 lb	38.80



**DRAMM
COLORSTORM™ MIX W/HOSE
#65085**



Contents:

- (6) Circular Base Impulse Sprinkler – 1 ea. Red, Orange, Yellow, Green, Blue, Berry
- (12) Oscillating Sprinkler; Waters Up to 3,036 sq. ft.; Durable Metal w/Variable Settings – 2 ea. Red, Orange, Yellow, Green, Blue, Berry
- (12) Turret Sprinkler; 9-Pattern Sprinkler; Durable Metal Base – 2 ea. Red, Orange, Yellow, Green, Blue, Berry
- (12) Premium Rubber Hose; Crush Proof Fittings; 5/8" x 50' – 2 ea. Red, Orange, Yellow, Green, Blue, Berry
- (6) Spinning Sprinkler; Durable Metal; Waters Up to 38' Dia. – 1 ea. Red, Orange, Yellow, Green, Blue, Berry
- (6) Water Timer; Up to 120 Minute Duration – 1 ea. Red, Orange, Yellow, Green, Blue, Berry
- (6) Whirling Sprinkler; Durable Metal; 3 Arm; Waters Up to 38' Dia. – 1 ea. Red, Orange, Yellow, Green, Blue, Berry
- (6) Stake Base Impulse Sprinkler; Durable Metal; On 6" Stake w/Step; Waters Up to 82' Dia. – 1 ea. Red, Orange, Yellow, Green, Blue, Berry
- (6) Sled Base; 4 Pattern Gear Spring on Sled Base; Waters Up to 40' Dia. – 1 ea. Red, Orange, Yellow, Green, Blue, Berry



Item #	Description	Price (\$)
49147	Sprinkler Mix w/Hose	1,744.80

**DRAMM
COLORSTORM™ PREMIUM RUBBER HOSE DISPLAY**

- Made from durable EPDM rubber that will not crack, check, or separate
- Hexagonal shape helps resist kinking
- 15% thicker wall than other rubber hoses on the market
- Hot water rated up to 160°
- Crush proof fittings will not pull off hose
- Can be left out in freezing temperatures without breaking



Contents

- (6) 1 Red, 1 Orange, 1 Yellow, 1 Green, 1 Blue, 1 Berry (Case)
- (24) 4 Red, 4 Orange, 4 Yellow, 4 Green, 4 Blue, 4 Berry (Pallet)

Item #	Description	Price (\$)
49148	ColorStorm™ Premium Hose, 50', 5/8", Case	249.42
49149	ColorStorm™ Premium Hose, 50', 5/8", Pallet	997.68



Dramm Cares!



Great for Hydroponic Growing

The Smart Pot is a soft-sided, fabric container for the gardener who wants a container that will help grow the best possible plant. It is a new and unique advancement in container technology that is better than any other method of container gardening.

- Releases heat
- Aerates the root zone
- Stops root circling
- Air prunes the plant's root structure

Item #	Description	Case Pack	Price (\$)
49150	#7, 14"W	24	137.00
49151	#10, 16"W	24	167.50
49152	#15, 18"W	24	198.00
49153	#20, 20"W	24	228.75



Go Green

Innovation is alive and well with the new, affordable Compost Sak from Smart Pot. This new concept in composting turns leaves, yard trimmings, and kitchen scraps into a 100% rich, organic soil improving agent.

- Over 100 gallon capacity
- Breathable fabric speeds up microbial activity – less start to finish time
- Reusable, lasts for years
- Lightweight and easy to use
- 30" wide by 38" tall, makes up to 12 cubic feet of pure compost

Item #	Description	Case Pack	Price (\$)
49154	Compost Sak™	12	305.50



See page 24 for information on the innovative High Caliper Root Control Bag.



BIG BAG BED LONG
FABRIC RAISED BED



Available in 3 "Long" Sizes: 6, 8, & 12 Feet!

- Non-rigid, flexible fabric conforms to the ground and can be placed on uneven or slightly sloping terrains
- Rectangle in size (16" x 16"), the long bed is ideal for plants, as well as crops like tomatoes, peppers, squash, melons, kale, lettuce, herbs and more

Item #	Dimensions	Soil Volume	Growing Area	Case Pack	Price (\$)
51755	16" x 16" x 6'	10.7 cu ft	8 sq ft	4	142.75
51756	16" x 16" x 8'	14.2 cu ft	10.7 sq ft	4	178.50
51757	16" x 16" x 12'	21.4 cu ft	16 sq ft	4	255.00



BIG BAG BED
FABRIC RAISED BED

Have a garden in any location with the new fabric raised Big Bag Bed from Smart Pot. With no required installation or construction – it's as easy as just unfolding, filling, planting, and enjoying your creation.

- Circular shape allows you to reach the center from any position
- Warms quickly in spring – releases excessive heat in the summer
- Provides excellent drainage
- Air prunes roots for better root systems
- Prevents soil compaction

Item #	Description	Size	Case Pack	Price (\$)
49155	Original	50" x 12", 13.7 cu ft	12	305.50
49156	Junior	36" x 12", 5.9 cu ft	18	286.25
49157	Mini	24" x 8", 2.1 cu ft	24	228.75

FORMULATIONS AND CONDUCTIVITY IN MILLIMHOS (MMHOS)

This chart has been developed as a reference to verify the accuracy of fertilizer injectors. The chart is designed to be used in the following manner:

1. Determine the conductivity of your clear irrigation water.
2. Determine the conductivity of your fertilizer solution after it has been proportioned (at the emitter as it is applied to the plants).
3. Subtract the value of 1. (clear water) from 2. (fertilizer solution).
4. Compare this answer with the values on the chart to determine the parts per million of nitrogen being injected.

An Example: If a reading of irrigation water has a value of .2 mmhos and a value of 1.0 mmhos is obtained from the fertilizer-injected water using 20-20-20, the corrected value would be 1.0 - .2 = .80. A look at the chart indicates a value of .41 for 20-20-20 being injected at 100 PPM. With an allowance of + or - 10% this is well within range. To convert millimhos (mmhos) to micromhos (umhos) multiply by 1000.

The values on this chart were obtained under laboratory conditions using distilled water. The values obtained by the grower under field conditions could therefore, vary slightly (+10%) from values listed here. This chart is to be used with Plant Marvel's Nutriculture formulations. Other brands may be composed of different raw materials which would give different values, even though they are the same analysis.



FORMULA	PPM NITROGEN CONCENTRATION						
	50	100	150	200	300	400	500
4-25-35	1.30	2.60	3.90	5.20	7.80	10.40	13.00
5-40-17	1.43	2.85	4.28	5.70	8.55	11.40	14.25
7-40-17	.60	1.20	1.80	2.40	3.60	4.80	6.00
10-20-30	.50	.99	1.50	1.99	2.99	3.98	4.79
10-30-20	.48	.96	1.44	1.92	2.88	3.84	4.95
12-4-12	.17	.35	1.07	1.43	2.14	2.86	3.58
12-31-14	.42	.84	1.25	1.67	2.51	3.34	4.18
12-45-10	.36	.71	1.07	1.42	2.13	2.84	3.55
13-0-44	.48	.95	1.41	1.88	2.83	3.77	4.73
13-2-13	.37	.75	1.12	1.50	2.25	3.00	3.75
14-0-14	.37	.75	1.12	1.50	2.25	3.00	3.75
14-3-20	.35	.71	1.06	1.42	2.12	2.83	3.55
15-0-15	.34	.69	1.03	1.38	2.06	2.75	3.44
15-0-30	.36	.71	1.07	1.49	2.14	2.85	3.55
15-3-18	.35	.71	1.06	1.42	2.12	2.83	3.54
15-3-20	.35	.70	1.05	1.40	2.10	2.80	3.50
15-5-15	.36	.73	1.09	1.45	2.18	2.90	3.63
15-5-25	.38	.76	1.14	1.52	2.28	3.04	3.80
15-5-30	.37	.74	1.11	1.47	2.21	2.95	3.68
15-10-30	.35	.71	1.06	1.42	2.12	2.83	3.54
15-20-25	.33	.66	1.00	1.37	2.05	2.74	3.42
15-30-15	.32	.64	.96	1.28	1.93	2.57	3.21
16-3-16	.33	.68	1.02	1.36	2.04	2.72	3.37
16-4-12	.33	.68	1.01	1.35	2.04	2.70	3.37
17-0-17	.35	.70	1.05	1.40	2.10	2.80	3.50
17-5-17	.34	.68	1.01	1.37	2.04	2.70	3.40
17-17-17	.27	.54	.80	1.07	1.61	2.14	2.68
18-3-18	.34	.68	1.01	1.37	2.04	2.74	3.40
18-6-18	.34	.68	1.01	1.37	2.04	2.74	3.40
19-26-14	.21	.42	.63	.84	1.25	1.67	2.09
20-0-20	.21	.41	.62	.82	1.23	1.64	2.05
20-5-20	.33	.65	.98	1.30	1.96	2.62	3.25
20-5-30	.23	.47	.70	.93	1.39	1.86	2.33
20-7-19	.30	.60	.90	1.20	1.80	2.40	3.00
20-7-20	.33	.65	.99	1.30	1.95	2.60	3.25
20-10-20	.31	.62	.94	1.25	1.88	2.50	3.13
20-20-20	.21	.41	.62	.82	1.23	1.64	2.05
21-7-7 A	.31	.61	.92	1.22	1.83	2.44	3.05
21-7-7 N	.18	.36	.54	.72	1.07	1.43	1.80
21-8-18	.32	.64	.96	1.28	1.92	2.56	3.20
24-8-16	.21	.42	.63	.85	1.27	1.70	2.12
25-0-25	.15	.30	.45	.61	.92	1.22	1.52
25-5-20	.14	.30	.42	.61	.90	1.20	1.50
25-10-20	.16	.32	.49	.65	.98	1.30	1.63
25-15-10	.15	.31	.46	.62	.92	1.23	1.55
28-18-8	.10	.20	.30	.40	.60	.80	1.00
30-10-10	.11	.22	.33	.43	.66	.85	1.10

OUNCES of Fertilizer Required PER GALLON of Water to Achieve 100 PPM

Select the percentage of fertilizer element in the left hand column and the ratio of the injector across the top of the chart. Where they meet is the amount of fertilizer required per gallon of concentrate solution to achieve **100 Parts Per Million**.

For other PPM concentrations multiply the required amount by desired PPM and divide by 100.

Example: To feed at 400 PPM Nitrogen using a proportioner set at a ratio of 1:100 and using a fertilizer with a Nitrogen content of 20%.

20% and 1:100 intersect at 6.66 oz. The chart is at 100 PPM so $6.66 \times 400/100 = 26.64$ oz.

If the tank feeding the proportioner holds 5 gals, multiply the 26.64 oz. by 5 to get the total fertilizer required.

	1:15	1:50	1:100	1:150	1:200	1:250	1:300	1:350	1:400	1:500
3%	6.66	22.21	44.43	66.64	88.85	111.07	133.28	155.49	177.71	222
4%	5	16.66	33.32	49.98	66.64	83.3	99.96	116.62	133.28	166
5%	4	13.33	26.66	39.98	53.31	66.64	79.97	93.3	106.62	133
6%	3.33	11.11	22.21	33.32	44.43	55.53	66.64	77.75	88.85	111
7%	2.86	9.52	19.04	28.56	38.08	47.6	57.12	66.64	76.16	95.2
8%	2.5	8.33	16.66	24.99	33.32	41.65	49.98	58.31	66.64	83.3
9%	2.22	7.4	14.81	22.21	29.62	37.02	44.43	51.83	59.24	74
10%	2	6.66	13.33	19.99	26.66	33.32	39.98	46.65	53.31	66.6
11%	1.82	6.06	12.12	18.17	24.23	30.29	36.35	42.41	48.47	60.6
12%	1.67	5.55	11.11	16.66	22.21	27.77	33.32	38.87	44.43	55.5
13%	1.54	5.13	10.25	15.38	20.5	25.63	30.76	35.88	41.01	51.3
14%	1.43	4.76	9.52	14.28	19.04	23.8	28.56	33.32	38.08	47.6
15%	1.33	4.44	8.89	13.33	17.77	22.21	26.66	31.1	35.54	44.4
16%	1.25	4.17	8.33	12.5	16.66	20.83	24.99	29.16	33.32	41.7
17%	1.18	3.92	7.84	11.76	15.68	19.6	23.52	27.44	31.36	39.2
18%	1.11	3.7	7.4	11.11	14.81	18.51	22.21	25.92	29.62	37
19%	1.05	3.51	7.01	10.52	14.03	17.54	21.04	24.55	28.06	35.1
20%	1	3.33	6.66	10	13.33	16.66	19.99	23.32	26.66	33.3
21%	0.95	3.17	6.35	9.52	12.69	15.87	19.04	22.21	25.39	31.7
22%	0.91	3.03	6.06	9.09	12.12	15.15	18.17	21.2	24.23	30.3
23%	0.87	2.9	5.79	8.69	11.59	14.49	17.38	20.28	23.18	29
24%	0.83	2.78	5.55	8.33	11.11	13.88	16.66	19.44	22.21	27.8
25%	0.8	2.67	5.33	8	10.66	13.33	15.99	18.66	21.32	26.7
26%	0.77	2.56	5.13	7.69	10.25	12.82	15.38	17.94	20.5	25.6
27%	0.74	2.47	4.94	7.4	9.87	12.34	14.81	17.28	19.75	24.7
28%	0.71	2.38	4.76	7.14	9.52	11.9	14.28	16.66	19.04	23.8
29%	0.69	2.3	4.6	6.89	9.19	11.49	13.79	16.09	18.38	23
30%	0.67	2.22	4.44	6.66	8.89	11.11	13.33	15.55	17.77	22.2

GRAMS of Fertilizer Required PER LITRE of Water to Achieve 100 PPM

	1:15	1:50	1:100	1:150	1:200	1:250	1:300	1:350	1:400	1:500
3%	50	167	333	500	667	833	1000	1167	1333	1667
4%	37.5	125	250	375	500	625	750	875	1000	1250
5%	30	100	200	300	400	500	600	700	800	1000
6%	25	83	167	250	333	417	500	583	667	833
7%	21.43	71	143	214	286	357	429	500	571	714
8%	18.75	63	125	188	250	313	375	438	500	625
9%	16.67	56	111	167	222	278	333	389	444	556
10%	15	50	100	150	200	250	300	350	400	500
11%	13.64	45	91	136	182	227	273	318	364	455
12%	12.5	42	83	125	167	208	250	292	333	417
13%	11.54	38	77	115	154	192	231	269	308	385
14%	10.71	36	71	107	143	179	214	250	286	357
15%	10	33	67	100	133	167	200	233	267	333
16%	9.38	31	63	94	125	156	188	219	250	313
17%	8.82	29	59	88	118	147	176	206	235	294
18%	8.33	28	56	83	111	139	167	194	222	278
19%	7.89	26	53	79	105	132	158	184	211	263
20%	7.5	25	50	75	100	125	150	175	200	250
21%	7.14	24	48	71	95	119	143	167	190	238
22%	6.82	23	45	68	91	114	136	159	182	227
23%	6.52	22	43	65	87	109	130	152	174	217
24%	6.25	21	42	63	83	104	125	146	167	208
25%	6	20	40	60	80	100	120	140	160	200
26%	5.77	19	38	58	77	96	115	135	154	192
27%	5.56	19	37	56	74	93	111	130	148	185
28%	5.36	18	36	54	71	89	107	125	143	179
29%	5.17	17	34	52	69	86	103	121	138	172
30%	5	17	33	50	67	83	100	117	133	167



Acceptance of Terms

These terms and conditions shall govern all orders for seeds, bulbs, plants, supplies and other materials (“merchandise”) placed with Seller. All negotiations with salesmen or other agents of Seller are merged herein. Purchaser acknowledges that it has not relied on any representation not contained herein. No modification of these terms and conditions shall be effective unless in writing signed by Seller. Placement of the order shall constitute Purchaser’s offer to purchase the merchandise on these terms and conditions. All orders and contracts are subject to acceptance or rejection by Seller at its offices in Harrison, New York and shall be deemed accepted upon shipment by Seller.

Limitation of Warranty

Seller warrants, to the extent required by law, that merchandise conforms to the description appearing in Seller’s catalog and on container labels, within recognized tolerances. SELLER MAKES NO OTHER OR FURTHER WARRANTY, EXPRESS OR IMPLIED. ALL OTHER OR FURTHER WARRANTIES, INCLUDING ANY WARRANTIES OF MERCHANTABILITY OR FITNESS FOR A PARTICULAR PURPOSE ARE EXCLUDED, AND THERE ARE NO WARRANTIES WHICH EXTEND BEYOND THE DESCRIPTION ON THE FACE HEREOF.

Certain merchandise may be separately warranted by the manufacturer. Seller does not adopt or ratify any manufacturer warranties, express or implied, and Seller shall have no liability thereunder. Seller does not adopt or ratify any warranties, express or implied, made by Purchaser upon resale of the merchandise, and Seller shall have no liability thereunder.

Purchaser agrees to defend, indemnify and hold Seller harmless from and against any liability of any kind to any person arising out of any warranty, express or implied, made by Purchaser upon resale of the merchandise. Seller shall have no liability for breach of warranty unless notice of any breach is given within a reasonable time, not to exceed thirty (30) days, after such breach is or should have been discovered. Any action for breach of warranty must be commenced within one year after the cause of action has accrued.

Limitation of Remedy

PURCHASER’S SOLE AND EXCLUSIVE REMEDY SHALL BE REFUND OF THE PURCHASE PRICE. SELLER’S LIABILITY, WHETHER FOR BREACH OF CONTRACT, BREACH OF WARRANTY, NEGLIGENCE, PRODUCTS LIABILITY, OR ANY OTHER THEORY OF LIABILITY, IS LIMITED TO THE AMOUNT OF THE PURCHASE PRICE. UNDER NO CIRCUMSTANCES SHALL SELLER BE LIABLE FOR DAMAGES IN EXCESS OF THE PURCHASE PRICE, OR FOR ANY SPECIAL, INCIDENTAL, INDIRECT OR CONSEQUENTIAL DAMAGES.

Confirmation and Governing Law

The law of the State of New York shall govern the rights, duties and obligations of the parties. Purchaser hereby submits to the jurisdiction of the courts of that State as to any dispute arising out of the contract between the parties and agrees that any litigation between the parties shall be brought in the Supreme Court of New York located in Westchester County, New York. In the event of litigation, the prevailing party shall be entitled to recover reasonable attorney’s fees in addition to any other award.

Prices

All prices are subject to change without notice. The price in effect at time of shipment will prevail. Prices do not include installation; Seller takes no responsibility, and shall have no liability for installation.

Payment

Payment is due in accordance with terms specified on invoice. All payments shall be made in U.S. funds. In the event of default in the payment of any amount when due, and in addition to all other rights and remedies available to Seller, SELLER SHALL BE ENTITLED TO COLLECT A LATE CHARGE OF 1.5% PER MONTH (18% PER YEAR) OR THE MAXIMUM RATE ALLOWED BY LAW, WHICHEVER IS LESS, ON ALL AMOUNTS PAST DUE FROM THE DATE DUE UNTIL THE DATE PAID.

Inspection and Return Policy

Purchaser should inspect merchandise upon receipt. Seller shall have no liability for any defect unless notice is given promptly, not to exceed thirty (30) days after such defect is or should have been discovered. In cases of loss or damage due to transportation, Purchaser should obtain and forward an inspection report to Seller’s Traffic Department within fifteen (15) days of delivery. No merchandise conforming to the Purchaser’s order may be returned without Seller’s prior written authorization. Requests to return merchandise and any complaints or claims not arising under the Seller’s warranty must be made within thirty (30) days after delivery. All returns must be in accordance with Seller’s shipping instructions with freight paid by Purchaser. Returns of conforming merchandise are subject to a 10% restocking charge.

Delays, Shortages and Substitutions

Seller shall not be responsible for delays in delivery or for losses resulting from such delays due to unforeseen, supervening circumstances. Seller reserves the right to make partial shipment if full shipment is commercially impracticable. In the event of shortages, Seller may substitute such other, similar merchandise as is available.

Survival

If any provision of the terms and conditions of sale stated herein and on the face hereof shall for any reason be held prohibited by or invalid under applicable law, in whole or in part, such provision shall be ineffective to the extent of such prohibition or invalidity, without invalidating the remainder of such provision or the remaining provisions hereof.

Protected Varieties

Varieties listed with the symbols PP# (Plant Patent Number), USPP or PAP (U.S. Patent Pending), PVPA (Plant Variety Protection Act Certificate issued), PVPAP (Plant Variety Protection Act Pending), BR (Breeder’s Rights certificate issued) or BRP (Breeder’s Rights Protection Pending) are protected by U.S. or foreign plant patents or plant variety protection laws. These varieties may not be reproduced without authorization. The breeder (or authorized representative) has the right to inspect customers’ nurseries during normal business hours to assess compliance with the restrictions on use of protected varieties.

Cool Glitters from Gloeckner!



See page 141 for the full assortment of Glitter color options.

Need a Helpful Hand?

See pages 2 & 3 for the listing of the Gloeckner Field Representatives – including yours!

A

65 Touch'N Flo Pro Trigger Valve (Dramm).....	76
a.m.a Thirst Quencher	37
Acme Fans.....	106-109
Acme Wall Shutters.....	106
Actinovate® SP Biological Fungus Control	55
Adept 25 WP	56
Advancing Alternatives Curtains & Accessories.....	96-97
Agitation/Aeration Bucket (Dramm).....	65
Agra Lock Poly Fastener.....	103
Agra Tech Greenhouses/Benches	84-91
Agri-Meters	62
Agritape Root Zone Heaters	130
Akari SC	56
Al's Flower Pouch II™.....	37
Aluminet® Screens/Shade Fabric	122
Aluminum Shutters (Schaefer)	107
Ammonium Molybdate.....	47
Anchor Pins (DeWitt).....	122
Anderson Injectors.....	61
Antel/Cayson Equipment.....	68
Anti-Insect Screens.....	122
AntiCondens® (Mardenkro).....	105
Aquamat®.....	80
Asco Solenoid Valve.....	83
Attain.....	59
Attko Greenhouses.....	Inside Front Cover, 92-93
Autofogs™ (Dramm).....	65
Autovalve™/Mist Autovalve™ (Dramm).....	83
Avid.....	56
Azalea Pots.....	7, 14, 37
Azatin	56

B

B-Nine®.....	54
Backpack Sprayers.....	67

Bamboo Stakes	131
Bamboo Supplies.....	131
Bamboo Trellis	131
Banrot 40WP	55
Barnel USA Tools.....	125
Bartlett Controllers.....	111
Basket Buddys Baskets	35
Batten Tape	105
Beethoven® TR Miticide/Insecticide.....	59
Belden Plastics Containers.....	36-37
Bench Frames – Fiberglass.....	91
Bench Matting (Texel)	80
Bench Tops (A-V)	91
Benches	91
Berger Substrates.....	41
Berry Plastics.....	100-101
Berry Precision Seeder	69
Big Bag Beds (High Caliper)	145
BioSafe Systems Chemistries.....	51
BioWorks® Fungicides/Insecticides	52-53
Blankets	121
Blue Fertilizer Dye.....	44
Bonsai Watering Nozzle.....	76
Bonzi™.....	54
Booms & Boomerangs	77
Bostitch Tools	125
Brass Hose Swivel	75

C

C-Flex/Cintoflex C Deer Fences (Tenax).....	118
Calcium Chloride Dihydrate.....	47
Camelot® Fungicide & Bactericide.....	55
Cane Caps (Tyne).....	133
Cane Supports (Tyne).....	133
Canvas Sterilizing Hose.....	117
Cap 'N' Grow (Tyne)	133
Capmat II Distribution Kits (Phytotronics).....	81
Capmat™ II Capillary Matting (Phytotronics).....	81

Capsil	56
Carefree (Jiffy).....	39
Chemicals.....	51-59
Chipco 26019 WP	55
Chrysal Alesco Foliar Spray	50
Citric Acid	47
Clear Glue.....	141
Cleary 3336-F.....	55
Clip-Its (DeWitt).....	122
Clip-On Trellis	132
The Cold Frame Greenhouse (Agra Tech).....	89
Coldfogger™ (Dramm)	65
Colorstorm™ Hose Crimper.....	81, 144
Colorstorm™ Premium Hose	81, 144
Companion® (Growth Products).....	53
Compost Sak	145
Concise® Growth Regulator.....	54
Conserve SC.....	56
Containers	6-37
Containers (HC).....	12-24
The Continental Greenhouse (Agra Tech).....	86
Controllers.....	111-112
Corona Tools.....	124
Cotton Twine Cone	133
Coveralls (Tyvek).....	134
Coverpots (Pöppelmann)	11
Covers (Highland Supply)	136-137
Crimper, Rubber Hose (Dramm).....	81
Crop Protection.....	118-122
Cultivation Trays (Pöppelmann)	8-9
Cycocel.....	54

D

Decathlon® 20 WP	56
Decorative Planters.....	11, 23-24
DecoWraps Fastwraps	135
Decree 50 WDG	55
Deer Fence (Tenax)	118

Deer Nets	118
Delta T Heaters	112
Dewitt Shade Cloths	121
Dibble Pins	68
Digital Scale	59
Dilution Solutions Testers & Meters.....	62
Distance 1 GR.....	56
Dosatron Injectors/Accessories	60
Dramm Chemical Applications	65
Dramm Irrigation Systems	74
Dramm Products.....	64-67, 74-78, 81, 83, 144
Dramm Retail	144
Dramm Sprayers.....	66-67
Dribble Tubes (Dramm)	78

E

Eagle 20 EW	55
Earthway Precision Garden Seeder	69
Eckert's Greenhouse Products.....	35
Electronic Leaf (Phytotronics).....	82
Embossed Foils (Highland Supply).....	136
Endeavor	57
Environmental Controllers.....	111-112
Epsom Salts.....	47
Ethylbloc™ Ethylene Inhibitor	50
Evaporative Cooling Systems	110
Exhaust Fans	106-109
Eye Protection and Accessories.....	134

F

Fan-Jet (Acme)	109
Fan Nozzle (Dramm)	76
Fantasy Colors II™	142
Fascination	54
Felco Tools.....	124
Ferticart™ (Dramm)	65
Fertil™ Topdresser (Phytotronics).....	48

Fertilizer Injectors 60-61
 Fertilizers 44-47
 Fertiss® Soilless Growing Medium (Oasis) 43
 Fiber Grow Containers 24
 Filters Spin Clean Screen 77
 Fittings & Accessories 78-79
 Flexogen Hoses 82
 Flo-Master Sprayers 67
 Flo-Master Wall Shutters (Acme) 106
 Floral Stem Cutter (Barnel USA) 54
 Floramite SC 57
 Florel 54
 Flower Net 137
 Flower Support 118-121
 Fogg-It Nozzle 76
 Fogg-It Thumb Valve 76
 Foil 136-137
 Fox Drench Sprayers 63
 Frost Protection Blanket 121
 Fungicides 52-53, 55-56

G

Galina Polycarb® Polijuana 103
 Gallina Polycarbonate Sheets 102-103
 Garden Markers 129
 Garden Seeder (Earthway) 69
 Gas-Fired, Combustion Heaters 114-115
 General Supplies 123-144
 Glazing Bar & Cap (Agra Tech) 103
 Glitters and Accessories 141
 Gloves 134
 Gnatrol WDG 57
 Greenhouse Coverings/Accessories 98-105
 Greenhouse Equipment 106-117
 Greenhouse Shut-Off Valves 76
 Greenhouse Structures 84-95
 Gro-Link Mum Netting 119

Groove Tube Trays 31
 Ground Covers 120-121
 Growers Equipment 60-73
 Growing Systems (Seeder & Plug Dislodger) 68
 Growing Systems (Spray Lock) 105
 Growing Systems Containers/Trays 31
 Growth Products/Fertilizers 49
 Growth Regulators 54

H

Hanging Balls 33
 Hanging Baskets 10, 20-22, 24, 34, 36
 Hanging Baskets – Willow 34
 Hanging Baskets – Wire 34
 Hanging Baskets with Coco Liner 34
 Hanging Planters & Tree 34
 Harrell's Fertilizers 48
 HC Companies 12-24
 H.E. Anderson Injectors 61
 Heat Mats 130
 Heater Ventilation Systems 116
 Heaters 112-116
 Heritage 55
 Hi-Hose Watering System (Phytotronics) 82
 High Pressure Sodium Lights 73
 Highland Supply Covers 136-137
 Horizontal Air Flow Fans 109
 Horticultures® (Oasis) 43
 Hortonova Crop Support Net (Tenax) 118
 Hortus IBA Water Soluble Salts™ (Phytotronics) 50
 Hoses 81-82
 Hose Coupling Machine 82
 Hozon Brass Siphon Mixer 62
 Hyacinth Stakes 133
 Hydraulic Sprayers (Dramm) 66

I

IBA Water Soluble Salts 50
 Inflation Blowers 105
 Inflation Equipment 105
 Info Sticks 128
 Injection Molded Flats 17
 Injectors 60-61
 Insect Screens 122
 Insecticides 52-53, 56-59
 The Insulator Greenhouse Series (Agra Tech) 87
 Irrigation Controllers 83
 Irrigation Equipment & Supplies 74-83
 Irrrometer 83

J

J+ Advanced Ratio:Feeder® Controller (H.E. Anderson) 61
 Jack's Professional® Fertilizers 46-47
 Jain Irrigation Products 78-79
 JetFog Low Pressure Fog System (Dramm) 74
 JetRain (Dramm) 74
 Jiffy Products 38-40
 Jiffy-7 39
 Jiffy-70 38
 Jiffy-Mixes 40
 JiffyPot® & JiffyPot® R2 38
 Johnson CO₂ Generator 73

K-L

Kasco Protective Helmets 134
 Kool-Cel Evaporative Cooling System (Acme) 110
 Kruser Power Sprayers 63
 L.B. White Heaters 116
 Labels & Accessories 128-129
 Lada 2 F 57
 LED Lights 70-72
 Lighting 70-73

Lily Pot 37
 Link4 Controllers 112
 Living Wreaths 33
 Low Tunnels Hoop Supported Row Cover 119
 Lucid 57

M

M-Pede 57
 Macrolux® Sheeting (Resolite®) 104
 Marathon 1% Granular 57
 Marathon II 57
 Mardenkro Shading Systems .. 123, Inside Back Cover
 Markers 129
 MasterTag Tags 126-127, 152
 Matting & Accessories 80-81
 Mavrik Aquaflow 57
 Media Mixes 38-43
 Mini Max Thermometers 140
 Mist Controllers 83
 Mist Time™ (Dramm) 83
 Mist'r Drench Sprayers 63
 Misting & Water Controllers 83
 Misting Nozzles 75-76
 Miticides 56-59
 Modine Heaters 114-115
 Molt-X® 53
 Moss Baskets/Living Wreath/Hanging Balls 32-33
 Mother's Mix (Jiffy) 40
 Mum Nets 119
 Myron L Meters 62

N-O

Nemashield® Biological Control 53
 New & Featured Products 4-5
 Nivola Sulphur Evaporator 59
 The North Slope Greenhouse (Agra Tech) 88
 Nozzles 75-77

NutriFOG Carrier for PulseFOG (Dramm).....64	Poly-Patch Tape™.....103	ReduHeat® Liquid Greenhouse Shading (Mardenkro).....123	Siphon Mixer Hozon.....62
Oasis Products.....41-43, 50	Poly-Tex Greenhouses.....97	ReduSol® Liquid Greenhouse Shading (Mardenkro).....123	Sleeves.....138-139
Oasis® Growing Medium.....42-43	Poly-Vent.....97	Respirators.....134	SmartPots.....24, 145
One Touch™ High Flow™ Valve (Dramm).....76	Polycarb® Polijuana® Sheets (Gallina USA).....103	Retail Products.....144-145	Snow Powder.....143
Orcal® Slug-Fest All Weather Formula.....58	PolyRail Irrigation System (Dramm).....74	Rhizopon™ Rooting Hormones (Phytotronics).....50	Soax® Wetting Agent.....50
Ordering Information.....1	Pop Basket™.....37	Rings (Plant Support).....132	Soil Mix.....38-43
Organic 5-5-5 (Natural Alternatives).....58	Pöppelmann Pots & Containers.....6-11	Roll-Up Wall.....96-97	Soil Sterilizer (Pro-Grow).....117
Overture 35 WSP.....58	Poppers & Seeders.....68-69	Rootcubes® (Oasis).....42	Soil Testing Equipment.....62
P-Q			
P. L. Light Systems.....73	Pot Covers.....135-137	Rooting Agents.....52	Sol-Trace.....44
Paper Sleeves.....138-139	Pot Labels.....128	Rose Pot Trays.....31	Solar Light Greenhouse (Agra Tech).....84
Peat Pellets (Jiffy).....39	Preforma® Plant Plugs (Jiffy).....39	Round Pots.....12	Solenoid Valves and Accessories.....83
Pegs.....122	Pro-Grow Propagating Chamber.....69	Round Pot Carry Trays.....30	Speed Plant Covers®.....137
Pestrap™ Pest Control (Phytotronics).....53	Progibb T&O 4% (Gibberillic Acid).....54	Rubber Hose Crimper.....81	Sphagnum Moss Baskets.....32
pH Testers.....62	ProGro Shade & Ground Cover.....120	Rycar® Whitefly and Aphid Control.....58	Sphagnum Moss Planters.....32
Philips LED Lighting.....70-72	Propagating Chamber (Pro-Grow).....69	S	
Phyton-27.....56	Propagation Mats/Thermostat.....130	“S” Hooks – Extension Hangers.....34	Spray Suits.....140
Piccolo PGR (Paclobutrazol).....54	Propi-Star™ EC.....55	SA-20 Disinfectant.....59	Sprayers.....63-67
Plant Covers.....135-137	Protective Helmets (Kasco).....134	Safari.....58	Spreader Sticker Latron B-1956.....58
Plant Markers.....128-129	Protitizer® Seed & Plant Activator (Natural Alternatives).....51	Safety Equipment.....134	Spring Lock™ Film & Fabric Fastener.....103
Plant Marvel Fertilizers.....44-45, 144, 146-147	Pruning Shears.....124-125	Satin Sleeves.....138-139	Square Pots.....9, 27, 37
Plant Pie Containers.....26	PT1100 Pyrethrum TR.....59	Scale.....59	Square Pots (Pöppelmann).....9
Plant Rings & Stakes – Poly.....132	PT1300 Orthene TR.....59	Schaefer Fans.....107-110	Square Pot Carry Trays.....27
Plant Screens.....122	PulseFOG Fast Foggers (Dramm).....64	Seederman Needle Seeder.....69	Stainless Steel Scissors.....125
Plant Support Rings.....132	PulseFOG® Turbo ULV Pneumatic Cold-Fogger (Dramm).....64	Seeders.....68-69	Standard Flats.....25
Plant Tags.....126-127	PVC Solenoid Valve (Toro).....83	Sensaphone Alarm Systems.....140	Standard Inserts.....25
Plastic Labels.....128-129	Pylon.....58	Sentinel Monitoring System (Sensaphone).....140	Staplers.....125
Plastic Spin Clean Screen Filter.....77	Pylon Plant Markers & Pot Labels.....128	Shade Cloths.....120-122	Star Steel Structures.....94-94
Plier Stapler (Bostitch).....125	Pylon® TR Insecticide.....59	Shading Compound.....123	Steam Sterilization Covers.....117
Plug Dislodger.....68	R		
Plug Popper Plus.....68	R & D Sleeves.....138-139	Shears.....124-125	Steam-Flo Generator (Sioux).....117
Plug Trays.....28-29	Rack & Pinion Vents (Agra Tech).....85	Sheet Pegs (Tyne).....122	Stem Cutter.....125
Polycarb® Polycarbonate Sheets.....102	Rainpro™ (Dramm).....83	Shimmer Powders.....143	Stem-Clips.....133
Poly Film.....98-101	ReduClean® Cleaning Agent (Mardenkro).....123	Shut Off Valves.....76	Sub-Irrigation Trays.....31
Poly Lock.....103	ReduFuse® (Mardenkro).....123	Shutters.....106-108	Subdue MAXX.....56
Poly-Ag Corg Greenhouse Films.....98-99	ReduFuse® IR (Mardenkro).....123	Siebring Heaters.....113	Suffoil-X® Spray Oil.....53
Poly-Inflation Controller (Phytotronics).....105		Siebring Sprayers.....63	Sulphur Evaporator (Nivola B.V.).....59
			Sumagic.....54
			SureRoots® & SureRoots® Elite (T.O. Plastics).....29

add **VALUE** to your plants
by highlighting information
that appeals to consumers.



Consider our unique
stock tags to highlight
special consumer
trends and interest.

**In stock
Ready to ship**



Providing practical and affordable solutions for growers, retailers, and consumers!

mastertag.com

T

T-Labels 128
 T.O. Plastics Containers..... 25-30
 Table of Contents 1
 Tacker (Bostitch) 128
 Tags 126-127
 Talstar GH Flowable 58
 Tape-Loc (Jain)..... 79
 Taylor Thermometers 140
 Technical Support 146-147
 Tenax..... 118
 Terminal Strip (Agra Tech) 103
 Terms & Conditions..... 149
 Terra Plug – Bonded Media (Oasis) 41
 Testing Equipment 62
 Texel Bench Matting 80
 Therma Grow Heaters..... 116
 Thermalarm Alarm Thermometer 140
 Thermoform Pot Rings 132
 Thermoformed Round Pots & Matching Trays..... 6-8, 12-13
 Thermometers 140
 Thermostat/Watt Propagation Mats 130
 Thermostats 107, 116
 Thinwall Pots & Matching Trays..... 14-15
 Tools..... 124-125
 Topiary Art Works Containers 32-34
 Toplighting (Philips)..... 70
 Transport Trays (Pöppelmann) 8-9
 Trellises 131-132
 Triact-70..... 58
 Tristar 58
 Truban 25% EC..... 56
 Truban 30% WP 56
 True & Slim Inserts & Flats..... 16, 26
 Tube Trays 31
 Tube Weights 78

Tufflite Films (Berry Plastics)..... 100-101
 Turbulent Twin-Wall Drip Irrigation Hose (Jain) 79
 Twin-Wall Drip Hose (Jain) 79
 Twine (Cotton Cones) 133
 Twist-Ems® Ties 133
 Tyne Products..... 122, 128, 133
 Typar Crop Covers 120

U-V

Undertrays 31
 Universal Snap On Hanger 133
 Vacuum Carry Trays 13, 15-16
 Vacuum Flats..... 19
 Vacuum Inserts..... 18
 Vacuum Plug Trays..... 16
 Vacuum Pots & Trays 17
 Valves..... 76-77
 Vandana Tubeless Seeders (Growing Systems)..... 68
 Ventilation Systems (Agra Tech) 90
 Vibro Hand Seeder (Gro Mor)..... 69

W-Z

Water Breakers..... 75
 Water Heaters (Modine) 115
 Watering Tools 74-77
 Watermatics Plugs/Quick-Punch..... 77
 Waterworks Crystals..... 49
 Wedge® Growing Medium (Oasis®) 42
 Wedge® Plus Growing Medium (Oasis®)..... 42
 Welded Wire Flower Support..... 118
 Wet Wall Evaporative Cooling System (Schaefer) .. 110
 Wet Wall Pads/Evaporative Media (Schaefer)..... 110
 Wind/Rain Alarm 111
 Windmaster Fans (Acme) 106
 Wire Baskets 34
 Wood Labels 129
 Wood Trellis 132

How do you protect your crop against too much solar radiation?

ReduSystems is a line of smart coatings that help you optimize your greenhouse climate.

Want to know which ReduSystems coating is best for your crop and type of greenhouse? Use the ReduWizard tool for a free online product advice. Here we have brought together our experience and knowledge and advise you based on your situation and geographical location.

MAMMA MIA, IT'S TOO HOT IN HERE

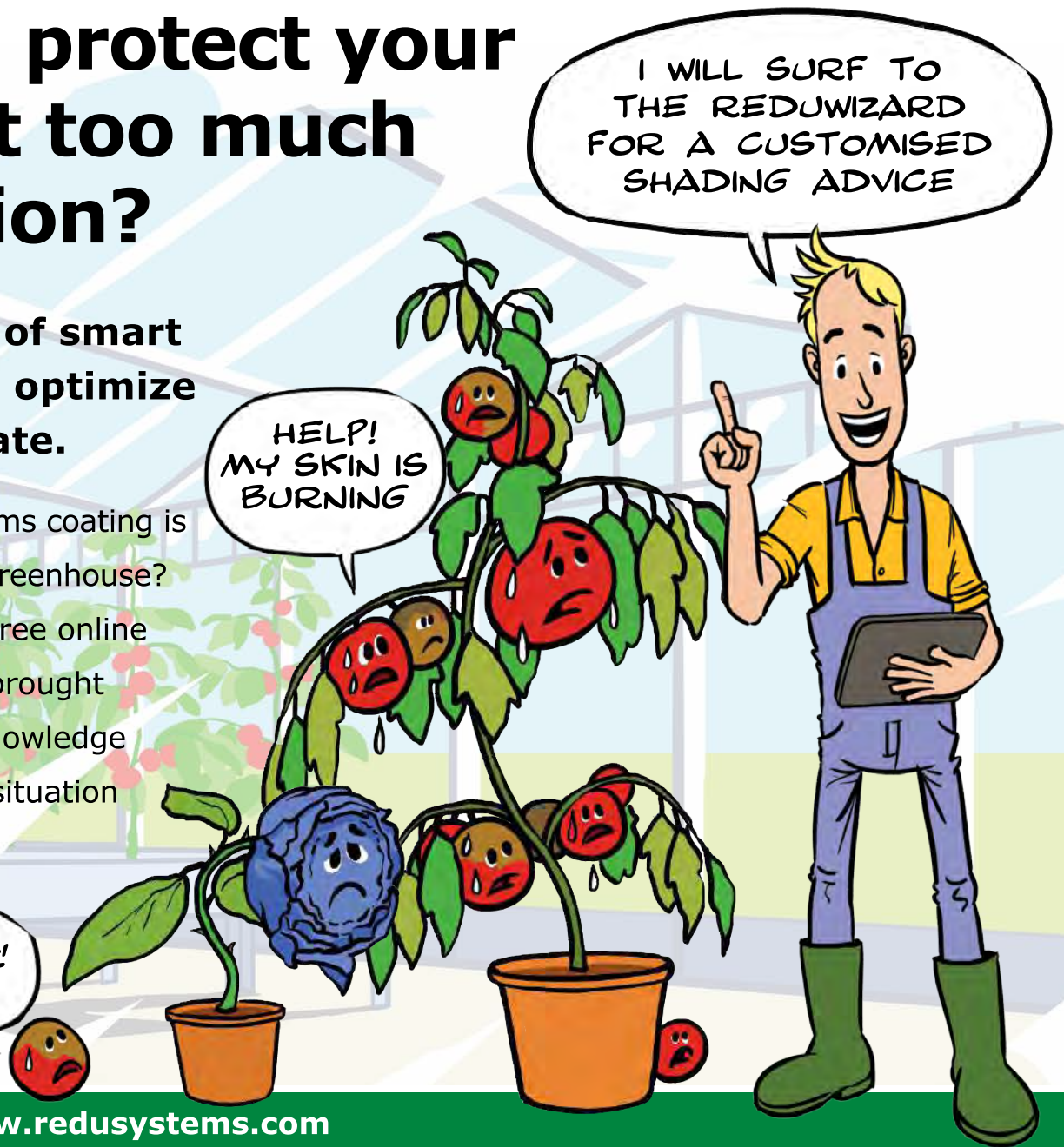

Use the ReduWizard on www.redusystems.com

ReduSystems is a group of removable coatings that gives the grower more control over their greenhouse climate. ReduSystems coatings are easy to apply, highly wear-resistant and can be removed at any time. No matter where in the world a crop is grown, ReduSystems offers crop specific value with innovative products and specialized solutions.

ReduSystems®
The bright side of growing

Fred C.
Gloeckner
&
Company,
Incorporated

550 Mamaroneck Avenue
Harrison, New York 10528-1609

800-345-3787

info@fredgloeckner.com

www.fredgloeckner.com

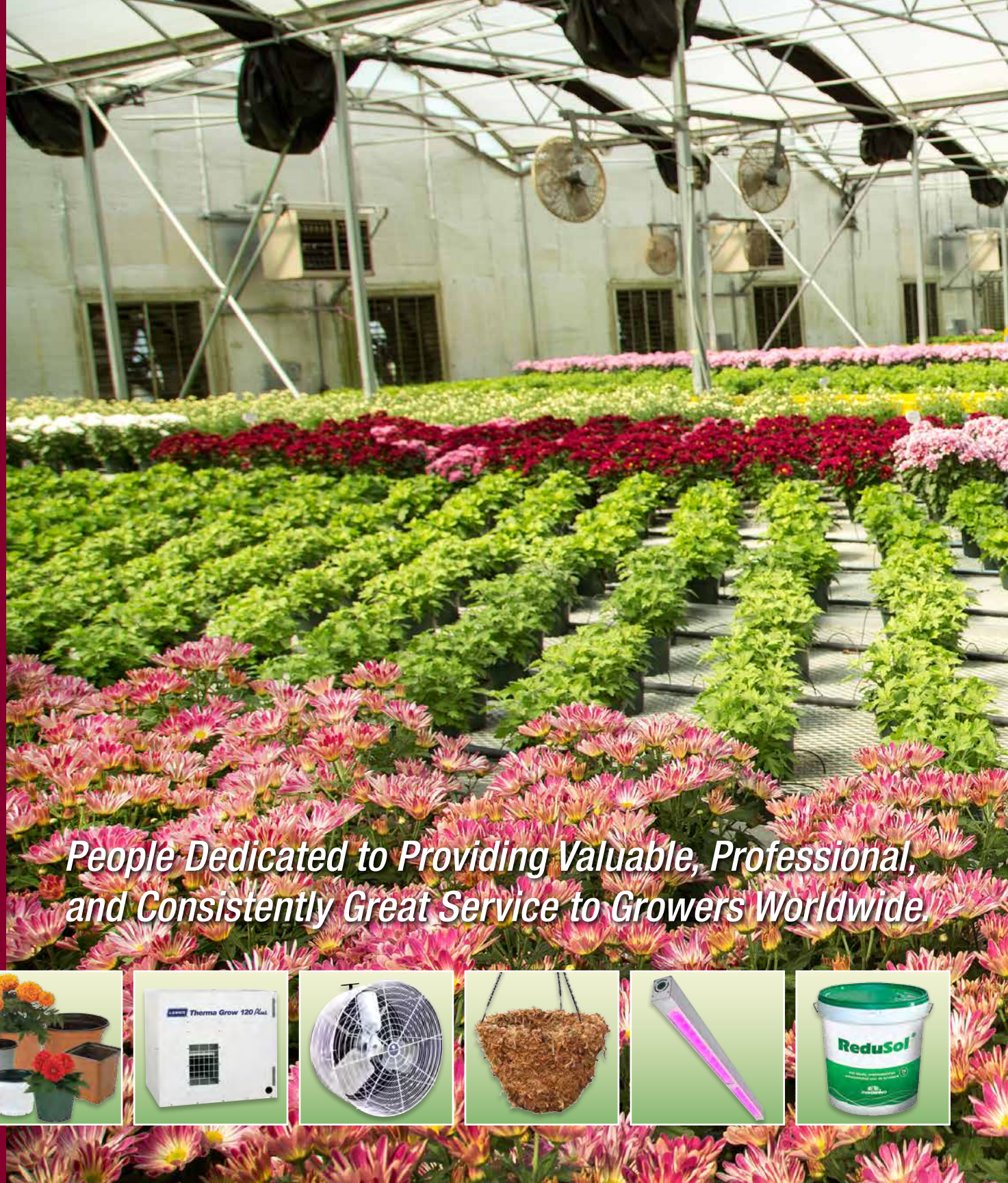

*People Dedicated to Providing Valuable, Professional,
and Consistently Great Service to Growers Worldwide.*

